

LEYENDA:

SYMBOLS:
SYMBOLES:

L H H1
H2 H3 A
D D1 D2
E E1 E2
F I I1
h h1 h2
a a1 a2
d ← → ↑ ↓

Dimensiones en milímetros.
Dimensions in millimeters.
Dimensions en millimètres.

H_{max}

Altura máxima en milímetros.
Maximum height in millimeters.
Hauteur maximale en millimètres.

H_{min}

Altura mínima en milímetros.
Minimum height in millimeters.
Hauteur minimale en millimètres.

Kg

Peso neto en kilogramos.
Net weight in kilograms.
Poids net en kilogrammes.

Gr

Peso neto en gramos.
Net weight in grams.
Poids net en grammes.



Código de producto.
Product Code.
Code de produit.



Colores disponibles.
Available colors.
Couleurs disponibles.



No son necesarias herramientas para el montaje del producto.
No tools required for assembly of the product.
Aucun outil requis pour l'assemblage du produit.



Diámetro en milímetros.
Diameter in millimeters.
Diamètre en millimètres.



Producto adaptado para lavavasos.
Product suitable for glasswashers.
Produit apte pour lave-verres.



Producto adaptado para lavaplatos.
Product suitable for dishwasher.
Produit apte pour lave-vaisselle.



Caudal de agua en litros por minuto.
Water flow rate in liters per minute.
Débit d'eau en litres par minute.



Temperatura máxima en grados centígrados.
Maximum temperature in degrees Celsius.
Température maximale en degrés Celsius.



Alcance máximo.
Maximum reach.
Portée maximum.



Capacidad en litros.
Capacity in liters.
Capacité en litres.



Peso máximo soportado.
Maximum load capacity.
Capacité de charge maximale.



Unidades contenidas en la caja o bolsa.
Units contained per box or bag.
Unités contenues par boîte ou sac.



Revoluciones por minuto.
Revolutions per minute.
Tours par minute.



Accesorio incluido en el producto.
Accessories included with the product.
Accessoires inclus avec le produit.



Accesorio no incluido en el producto.
Accessories not included with the product.
Accessoires non inclus avec le produit.



Número de soportes.
Number of supports.
Nombre de supports.



Orientación de desagüe.
Drain position.
Position d'égouttoir.



Número de huecos.
Number of holes.
Nombre de trous.



Número de puertas abatibles.
Number of hinged doors.
Nombre de portes battantes.



Número de puertas corredera.
Number of sliding doors.
Nombre de portes coulissantes.



Tipo de conexión eléctrica.
Type of electrical connection.
Type de connexion électrique.



Producto muy pesado.
Very heavy product.
Produit très lourd.



Normativa internacional Gastronom.
Gastronom international standards.
Norme internationale Gastronom.



Producto adaptado en altura para cocinas serie snack o modular.
Product height adapted to modular or snack bar kitchens.
Hauteur du produit adapté aux cuisines modulaires ou de restauration rapide.



Preste especial atención.
Pay special attention.
Prêtez particulière attention.



Ampliar información en la página.
More information on page.
Plus d'informations à la page.



Únicamente los productos con este logotipo cumplen con la certificación NSF.
Only products with this logo meet NSF certification.
Seulement les produits avec ce logo sont conformes aux certifications NSF.



Estanterías y estantes

Shelving and shelves
Rayonnages et étagères



Herrajes

Hooks and stainless steel fixtures
Ferrures et crochets



Tajos de troceo y fibras de corte

Chopping blocks and fibre boards
Billots de découpage et plaques



Cuchillería profesional

Professional knives
Coutellerie professionnelle



Lavamanos

Washbasins
Lave-mains



Fuentes de agua

Drinking fountains
Sources d'eau



Fregaderos

Sinks
Éviers



Grifería

Taps and fittings
Robinetterie



Mobiliario

Furniture
Meubles



Seguridad e Higiene

Health and safety
Sécurité et santé au travail



Complementos

Complements
Compléments



Condiciones generales

General conditions
Conditions générales



Fricosmos, S.A. contribuye a la conservación del Medio Ambiente mediante su aportación al sistema de separación, retirada y reciclado de nuestros envases con el sistema Ecoembes identificado con el punto verde.

Fricosmos, S.A. contributes to the preservation of the environment through its contribution to the procedure of selection, removal and recycling of our packages following the Ecoembes system identified with the green point.

Fricosmos, S.A. participe de la préservation de l'environnement moyennant sa contribution au procédé de sélection, retirée et recyclage de nos emballages selon le système Ecoembes identifié avec le point vert.





ESTANTERIAS Y ESTANTES

Shelving and shelves
Rayonnages et étagères

NOVEDADES

News
Nouveautés

Estanterías suspendidas Hanging wall shelves Étagères suspendues	16
Kit de fijación a techo para estanterías suspendidas Ceiling fixing kit for hanging shelves Kit de montage pour plafond pour étagères suspendues	16

Estanterías modulares

Modular shelving

Rayonnages modulaires

Características de fabricación:

Construidas totalmente en acero inoxidable, acabado satinado.
Doble pliegue con pestaña aplastada en los estantes, para evitar cortes y ganar resistencia.
Fácil montaje.
Gran diversidad de medidas para una máxima adaptación a su lugar de colocación.
Alturas disponibles desde 850 mm, para su utilización como mesas de apoyo, carros, etc., hasta 2950 mm para el mejor aprovechamiento del espacio.
Dos espesores de chapa disponibles y con la opción de poder solicitarlas con refuerzos soldados en su base, ver página 11.
Se puede regular la altura entre estante y estante cada 100 mm, con posibilidad de poner un estante a ras de suelo.
Pies regulables para una mayor estabilidad en cualquier suelo.
Posibilidad de colocación de ruedas, ver página 467.
Opcionalmente se pueden suministrar con kit de pletinas. Ver página 11.

Manufacturing characteristics:

Made totally in stainless steel shiny finished. Double fold with crushed fringe in shelves, to avoid any bad cut and to increase the resistance.
Easy mounting.
Great diversity of measures to allow a maximum fitting to the mounting room.
Available heights from 850 mm for its usage as auxiliary tables, chars, etc. up to 2950 mm for the best use of the room.
Sheet thick available in two measures with the option of order them with reinforcements fixed at its base. See page 11.
Height adjustment every 100 mm, with the possibility of mounting one shelf at the ground level.
Adjustable feet to allow a higher stability on any floor.
Possibility of fixing wheels. See page 467.
They can be supplied optionally with plates and hooks. See page 11.

Caractéristiques de fabrication:

Construit totalement en acier inoxydable finition satinée.
Double pli avec rebord aplati pour éviter des coupures et gagner en résistance.
Facilité de montage.
Grand diversité de mesures pour une maxime adaptation a l'endroit de installation.
Hauteur disponibles depuis 850 mm pour l'utilisation comme tables auxiliaires, chariots, etc, jusqu'à 2950 mm pour le mieux profit de l'espace.
Deux épaisseurs de tôle disponibles avec l'option de les solliciter avec renforcements soudés dans sa base. Voir page 11.
Hauteur réglable tous les 100 mm, avec la possibilité de monter une étagère au niveau du sol.
Pieds réglables pour une plus grande stabilité dans n'importe quel sol.
Possibilité de montage de rouelles. Voir page 467.
Optionnellement elles peuvent être fournies avec un kit de platines et crochets. Voir page 11.



Detalle de kit de pletinas acoplado a estantería.
Detail of plates set coupled in shelving.
Détail de kit de pletines accouplé dans le rayonnage.

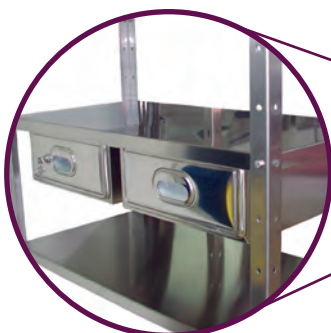

Posibilidad de acoplar cajones a estantes.
Drawer coupled possibility.
Possibilité de tiroir accouplé.

463



Detalle del pie del soporte de estantería.
Detail of shelving support base.
Détail du pied du support de rayonnage.



Posibilidad de acoplar ruedas a soportes de estantería.
Castor fixed to shelving supports possibility.
Possibilité de rouelle accouplée dans supports de rayonnage.

Cuadro comparativo de estanterías modulares con estantes lisos de 0.8 mm

Comparative table of modular shelving with non-perforated 0.8 mm shelves
Tableau comparatif de rayonnages modulaires avec étagères lisses de 0,8 mm

L	A	H	Número de estantes Number of shelves Numéro d'étagères			
			3	4	5	6
			€	€	€	€
800	300	1.750	197,40	227,20	257,00	286,80
1.000	300	1.750	218,40	255,20	292,00	328,80
1.200	300	1.750	242,40	287,20	332,00	376,80
1.400	300	1.750	257,40	307,20	357,00	406,80
800	400	1.750	218,40	255,20	292,00	328,80
1.000	400	1.750	242,40	287,20	332,00	376,80
1.200	400	1.750	257,40	307,20	357,00	406,80
1.400	400	1.750	287,40	347,20	407,00	466,80
800	500	1.750	242,40	287,20	332,00	376,80
1.000	500	1.750	257,40	307,20	357,00	406,80
1.200	500	1.750	287,40	347,20	407,00	466,80
1.400	500	1.750	302,40	367,20	432,00	496,80
800	600	1.750	257,40	307,20	357,00	406,80
1.000	600	1.750	287,40	347,20	407,00	466,80
1.200	600	1.750	302,40	367,20	432,00	496,80
1.400	600	1.750	329,40	403,20	477,00	550,80

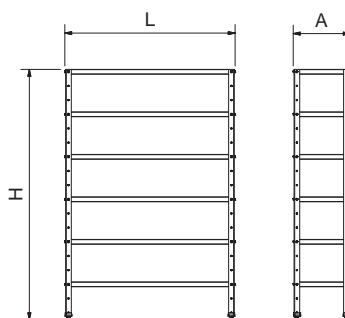

Estos precios incluyen estantes, soportes, tornillos y tuercas.

Shelves, shelving supports, nuts and bolts included in these prices.

Etagères, supports de rayonnage et vis à écrou compris dans ces prix.

Cuadro comparativo de estanterías modulares con estantes lisos de 1.5 mm

Comparative table of modular shelving with non-perforated 1.5 mm shelves
Tableau comparatif de rayonnages modulaires avec étagères lisses de 1.5 mm

L	A	H	Número de estantes Number of shelves Numéro d'étagères			
			3	4	5	6
			€	€	€	€
800	300	1.750	242,40	287,20	332,00	376,80
1.000	300	1.750	278,40	335,20	392,00	448,80
1.200	300	1.750	311,40	379,20	447,00	514,80
1.400	300	1.750	344,40	423,20	502,00	580,80
800	400	1.750	281,40	339,20	397,00	454,80
1.000	400	1.750	314,40	383,20	452,00	520,80
1.200	400	1.750	347,40	427,20	507,00	586,80
1.400	400	1.750	386,40	479,20	572,00	664,80
800	500	1.750	314,40	383,20	452,00	520,80
1.000	500	1.750	347,40	427,20	507,00	586,80
1.200	500	1.750	386,40	479,20	572,00	664,80
1.400	500	1.750	422,40	527,20	632,00	736,80
800	600	1.750	347,40	427,20	507,00	586,80
1.000	600	1.750	386,40	479,20	572,00	664,80
1.200	600	1.750	422,40	527,20	632,00	736,80
1.400	600	1.750	455,40	571,20	687,00	802,80

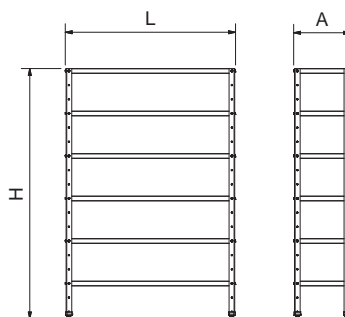

Estos precios incluyen estantes, soportes, tornillos y tuercas.

Shelves, shelving supports, nuts and bolts included in these prices.

Etagères, supports de rayonnage et vis à écrou compris dans ces prix.

Estantes lisos para estanterías modulares

Flat shelves for modular shelving
Étagères lisses pour rayonnages modulaires

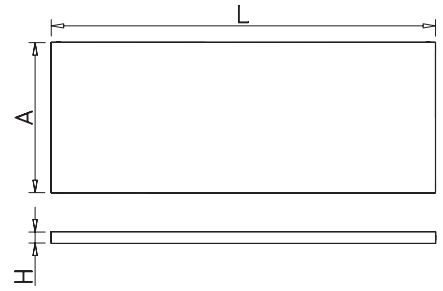
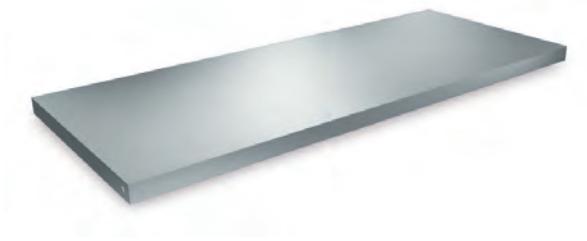

			Estantes de 0,8 mm 0,8 mm shelves Étagères 0,8 mm				Estantes de 1,5 mm 1,5 mm shelves Étagères 1,5 mm			
L	A	H	Kg	Barcode	€	Kg	Barcode	€		
800	300	35	2,20	010202	27,00	4,16	010402	42,00		
1.000	300	35	2,78	010204	34,00	5,14	010404	54,00		
1.200	300	35	3,24	010206	42,00	6,02	010406	65,00		
1.400	300	35	3,76	010208	47,00	7,02	010408	76,00		
800	400	35	2,76	010210	34,00	5,32	010410	55,00		
1.000	400	35	3,40	010212	42,00	6,30	010412	66,00		
1.200	400	35	4,04	010214	47,00	7,71	010414	77,00		
1.400	400	35	4,76	010216	57,00	9,00	010416	90,00		
800	500	35	3,36	010218	42,00	6,16	010418	66,00		
1.000	500	35	4,14	010220	47,00	7,68	010420	77,00		
1.200	500	35	4,90	010222	57,00	9,12	010422	90,00		
1.400	500	35	5,56	010224	62,00	10,58	010424	102,00		
800	600	35	3,86	010226	47,00	7,30	010426	77,00		
1.000	600	35	4,94	010228	57,00	8,98	010428	90,00		
1.200	600	35	5,60	010230	62,00	10,70	010430	102,00		
1.400	600	35	6,50	010232	71,00	12,34	010432	113,00		

Soportes de estantería

Shelving supports
Supports de rayonnage



Características:

Espesor del acero 2 mm.
Admiten estante a nivel del suelo.
Separación entre taladros de 100 mm.

Characteristics:

Stainless steel thickness 2 mm.
Shelf allowed at ground level.
Holes are 100 mm apart.

Caractéristiques:

Acier inoxydable épaisseur 2 mm.
Étagère admise au niveau du sol.
Ecart des trous tous les 100 mm.

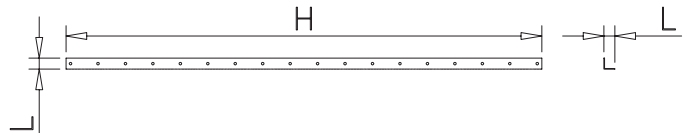

H	L	Kg	Barcode	€
850	40x40	1,05	011002	18,00
1.050	40x40	1,24	011004	19,00
1.450	40x40	1,62	011006	26,00
1.750	40x40	2,02	011008	27,00
2.050	40x40	2,38	011010	31,00
2.350	40x40	2,58	011012	39,00
2.950	40x40	2,69	011014	49,00

Refuerzos soldados a estantes

Welded reinforcements for shelves
Renforts soudés aux étagères

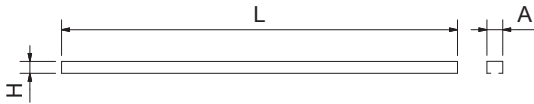

Características:
Aumentan la capacidad de carga. Ver página 12

Characteristics:
Increase load-capacity. See page 12

Caractéristiques:
Sert à améliorer la capacité de chargement. Voir page 12



L	A	H	Kg	Barcode	€
800	40	30	1,02	011202	16,50
1.000	40	30	1,18	011204	20,00
1.200	40	30	1,41	011206	22,00
1.400	40	30	1,65	011208	24,00

Tornillos y tuercas para estantes

Nut and bolt for shelves
Vis à écrou pour étagères

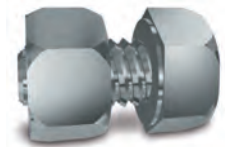
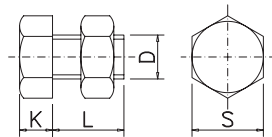

	D	L	S	K	Gr	Barcode	€
Tornillo Bolt Vis	M8	12	13	5,3	7,00	421012	0,24
Tornillo Bolt Vis	M8	25	13	5,3	11,00	421016	0,32 *
Tuerca Nut Écrou	M8		13	5,3	4,00	421056	0,11



Tornillo para unión de estanterías.
Screw for shelving units union.
Vis pour union d'étagères.

8 tornillos y tuercas por estante.
8 nut and bolt for shelf.
8 vis à écrou pour étagère.

Kit de pletinas para estanterías

Plate kit for shelves
Kit de platines pour rayonnages

L	A	Kit 1 Pletina One plate kit Kit de 1 platine	Pletina Opcional Optional plate Platine en option	€
800	300	012802	012850	142,00
	400	012810		152,00
	500	012818		162,00
	600	012826		172,00
1.000	300	012804	012852	152,00
	400	012812		162,00
	500	012820		172,00
1.200	600	012828	012854	182,00
	300	012806		162,00
	400	012814		172,00
1.400	500	012822	012856	182,00
	600	012830		191,00
	300	012808		172,00
1.400	400	012816	012856	182,00
	500	012824		192,00
	600	012832		201,00

Dotación de cada kit de pletinas:

Una pletina de la medida del largo de la estantería, con una "U" soldada a cada extremo. Dos pletinas de la medida del ancho de la estantería preparadas para atornillar a los soportes. Tornillería.

Each plate kit consists of:
One plate of the same length as the shelves with a U-shaped bracket welded to either end. Two plates of the same width as the shelves ready to be bolted to the supports. Nuts and bolts.

Dotation de chaque kit de platines:
Une platine mesurant la largeur de l'étagère avec deux "U" soudés à chaque extrémité. Deux platines mesurant la largeur de l'étagère conçues pour être vissées aux supports. Visserie.



Resistencia de carga por estante de 0.8 mm de espesor

Load strength per 0.8 mm thick shelf

Résistance de charge par étagère de 0,8 mm d'épaisseur



Las cargas se consideran uniformemente repartidas en la superficie del estante.

It is assumed that loads are evenly distributed on the shelf surface.
On considère que les charges sont réparties uniformément sur la surface de l'étagère.

Resistencia de carga en Kgs Kgs load strength Résistance de charge Kgs				
Dimensiones Dimensions Dimensions	Sin refuerzos Without reinforcement Sans renforts	1 refuerzo 1 reinforcement 1 Renforts	2 refuerzos 2 reinforcement 2 Renforts	3 refuerzos 3 reinforcement 3 Renforts
800x300	225	275	325	
1.000x300	175	225	275	
1.200x300	125	150	200	
1.400x300	100	125	175	
800x400	200	250	300	350
1.000x400	150	200	250	300
1.200x400	100	125	175	225
1.400x400	75	100	150	200
800x500	200	250	300	350
1.000x500	150	200	250	300
1.200x500	100	125	175	225
1.400x500	75	100	150	200
800x600	175	225	275	325
1.000x600	125	175	225	275
1.200x600	75	100	150	200
1.400x600	50	75	125	175

Resistencia de carga por estante de 1.5 mm de espesor

Load strength per 1,5 mm thick shelf

Résistance de charge par étagère par 1,5 mm d'épaisseur



Las cargas se consideran uniformemente repartidas en la superficie del estante.

It is assumed that loads are evenly distributed on the shelf surface.
On considère que les charges sont réparties uniformément sur la surface de l'étagère.

Resistencia de carga en Kgs Kgs load strength Résistance de charge Kgs				
Dimensiones Dimensions Dimensions	Sin refuerzos Without reinforcement Sans renforts	1 refuerzo 1 reinforcement 1 Renforts	2 refuerzos 2 reinforcement 2 Renforts	3 refuerzos 3 reinforcement 3 Renforts
800x300	300	350	400	
1000x300	250	300	375	
1200x300	150	200	275	
1400x300	125	175	225	
800x400	275	325	375	475
1000x400	225	275	350	450
1200x400	125	175	250	350
1400x400	100	150	200	300
800x500	275	325	375	475
1000x500	225	275	350	450
1200x500	125	175	250	350
1400x500	100	150	200	300
800x600	250	300	350	450
1000x600	200	250	325	425
1200x600	100	150	225	325
1400x600	75	125	175	275

Soporte de sobremesa y mural porta-cubetas Gastronorm

Worktop and wall fixed Gastronorm trays holder
Support sur table et mural porte-cuveaux Gastronorm



Características:

Fabricado en acero inoxidable.

Para uso de sobremesa o fijación mural (incluye tornillos para su fijación a la pared).

Admite cubetas de hasta 200 mm de profundidad.

Empleando los perfiles divisorios podrá ubicar numerosas combinaciones según sus necesidades.

Posibilidad de regular la inclinación.

No incluye las cubetas ni los perfiles.

Cubetas y tapas. Ver página 412.

Perfiles divisorios. Ver página 420.

Asa universal para cubetas. Ver página 420.



L	A	H	l	a	Kg	€
740	390	275	655	325	6,0	082803 150,00
1.150	390	275	1.065	325	7,5	082804 170,00
1.390	390	275	1.305	325	8,5	082806 190,00

Characteristics:

Manufactured in stainless Steel.

For worktop or wall mounted use (screws included).

It can lodge Gastronorm containers up to 200 mm depth.

You can carry out numerous combinations depending on your needs by using the dividing sections.

Possibility of lean adjustment.

Gastronorm containers and dividing sections not included.

Lids and containers, see page 412.

Dividing sections, see page 420.

Standard handle for Gastronorm containers, see page 420.

Caractéristiques:

Fabriqu  en acier inoxydable.

Il est con u   poser sur table ou   accrocher au mur.

Il peut loger des bacs Gastronorm jusqu'  200 mm de profondeur.

Vous pouvez r aliser des combinaisons nombreuses selon vos besoins en utilisant les sections de s paration

Possibilit  de r gler l'inclinaison.

Bacs GN et des sections de s paration n'ont pas inclus.

Couvercles et les r cipients, voir page 412.

Sections de s paration, voir page 420.

Poign e standard pour r cipients Gastronorm, voir page 420.

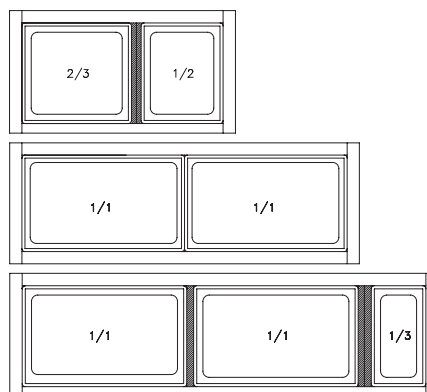

Estantes murales cartelas modelo compacto

Fixed wall shelves
Étagères murales modèle compact

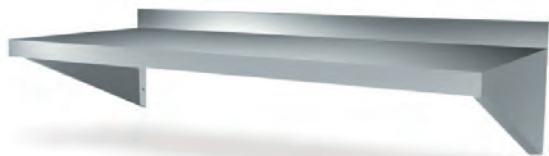

Characteristics:

The main characteristic of these shelves is that they are made in one only piece, with all their angles welded, back fringe as well as double fold to avoid any burrs or dirtiness deposits.

These shelves generally use our bolt code 421034 and our plug code 409824. See page 69.

Caractéristiques:

La principale caractéristique de ces étagères est qu'elles sont fabriquées d'une seule pièce, avec tous ses arêtes soudées, dossierer postérieur, ainsi que double pli, pour éviter des bavures et l'accumulation du saleté.

Généralement, cet étagères utilisent notre vis code 421034 et notre cheville code 409824. Voir page 69.



Tornillos y tacos no incluidos en el precio.
Bolts and plugs not included in the price.
Les vises et les chevilles ne sont pas inclus dans le prix.

Características:

La principal característica de estos estantes es su construcción en una sola pieza, con todas sus aristas soldadas y peto posterior, así como doble pliegue aplastado para evitar rebabas y depósitos de suciedad.

Estos estantes se suelen atornillar a la pared con nuestro tornillo cód. 421034 y con el taco cód. 409824. Ver página 69.

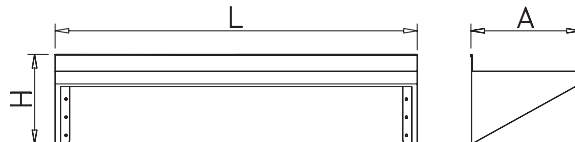

L	A	H	Kg	Barcode	€
1.000	300	245	3,50	011402	148,00
1.250	300	245	4,10	011404	160,00
1.500	300	245	4,70	011406	187,00
1.000	400	245	4,28	011408	171,00
1.250	400	245	5,04	011410	185,00
1.500	400	245	5,80	011412	203,00
1.000	500	245	5,08	011414	189,00
1.250	500	245	6,00	011416	204,00
1.500	500	245	6,70	011418	215,00

Estantes murales de tubo

Tube wall shelves
Étagères murales en tube



These shelves generally use our bolt code 421034 and our plug code 409824. See page 69.

Généralement, cet étagères utilisent notre vis code 421034 et notre cheville code 409824. Voir page 69.



Tornillos y tacos no incluidos en el precio.
Bolts and plugs not included in the price.
Les vises et les chevilles ne sont pas inclus dans le prix.

Estos estantes se suelen atornillar a la pared con nuestro tornillo cód. 421034 y con el taco cód. 409824. Ver página 69.

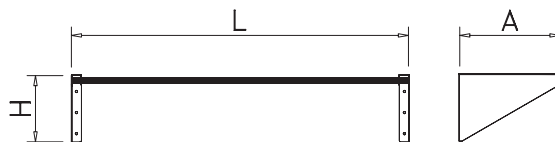

L	A	H	Kg	Barcode	€
750	300	200	4,00	011902	115,00
1.000	300	200	4,11	011904	121,00
750	400	200	4,80	011906	129,00
1.000	400	200	5,65	011908	133,00

Estante mural especial microondas

Wall shelf - specially for microwaves
Étagère murale spéciale micro - ondes

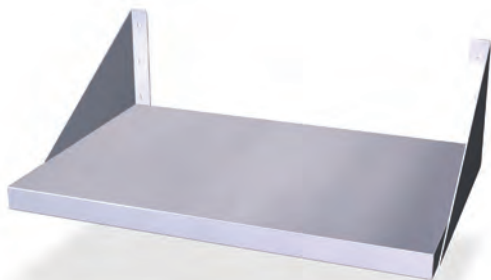

Tornillos y tacos no incluidos en el precio.
Bolts and plugs not included in the price.
Les vises et les chevilles ne sont pas inclus dans le prix.

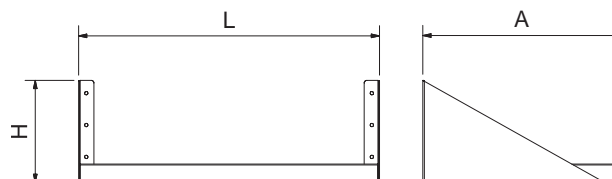

L	A	H	Kg	Barcode	€
590	388	200	3,00	015202	89,00



Basados en las medidas internacionales GASTRONORM. Podrá intercambiar los estantes por recipientes, parrillas y fibras GN.

Based in the international standard GASTRONORM. You can replace the shelves for Gastronorm containers, grills and GN fibres.

Basé dans le standard international GASTRONORM. Vous pouvez remplacer les étagères pour les bacs, grilles GN et plaques GN.

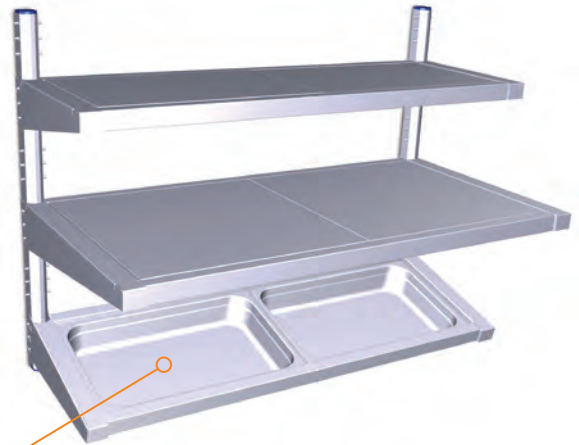

412

Cubetas Gastronorm.
Gastronorm trays.
Cuveau gastronorm.

Configuraciones:
Range of configurations:
Gamme de configurations:

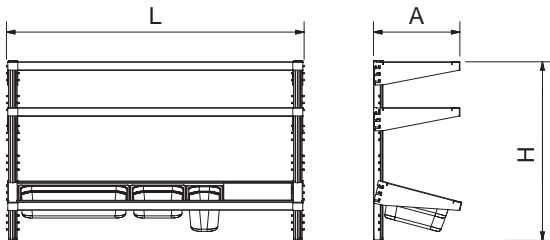
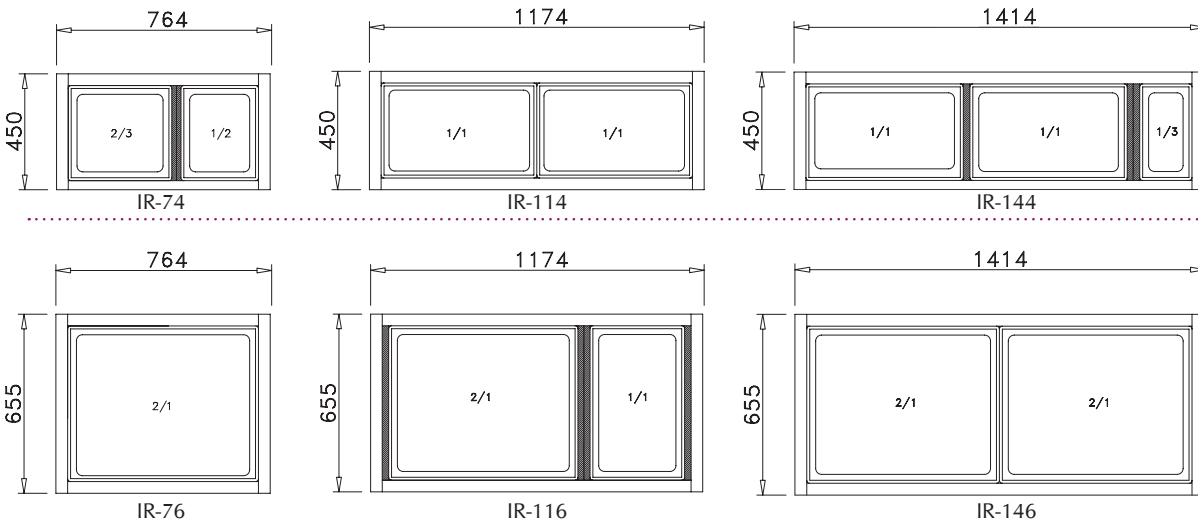

Se instala con facilidad y rapidez. Los estantes se regulan a la altura deseada SIN HERRAMIENTAS, incluso su inclinación.

It can be mounted easily and quickly. Height and lean adjustment according to your needs WITHOUT TOOLS.

Installation facile et rapide. Réglage en hauteur et inclinaison selon vos besoins SANS OUTILS.

Opcional / Optional / Optionnel

Estantes regulables imagine
Imagine adjustable wall shelves
Étagères réglables imagine

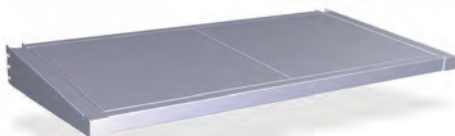

L	A	Kg	Barcode	€
764	413	8,2	IR-74	121,00
1.174	413	10,4	IR-114	145,20
1.414	413	12,4	IR-144	180,40
764	614	10,6	IR-76	140,80
1.174	614	12,8	IR-116	173,80
1.414	614	17,8	IR-146	209,00

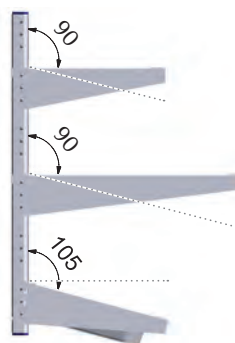

Montantes
Uprights
Montants



H	Kg	Barcode	€
860	1,5	013606	57,20
1.700	3,0	013604	89,10

Esterías suspendidas

Hanging wall shelves
Étagères suspendues



Fabricadas totalmente en acero inoxidable. Esta gama de estanterías suspendidas está diseñada para ayudarle a organizar su espacio de trabajo con seguridad e higiene.

Los estantes son regulables en altura y cuentan con reborde perimetral que dará seguridad al contenido del estante, evitando a su vez posibles derrames. Sus detalles de fabricación proporcionan firmeza y seguridad a toda la estructura.

Totally made in stainless steel. This range of hanging wall shelves is designed to help you to organize your working space in a safe and hygienic way. Their shelves are height adjustable, and are provided with a perimeter flange that will allow a secure storage and will avoid any accidental edge leakage. The particular manufacturing features provide stability and robustness to the whole structure.

Fabriqué entièrement en acier inoxydable cette gamme de rayonnages suspendus est conçu pour vous aider à organiser votre espace de travail en total sécurité et hygiène. Les étagères sont réglables en hauteur et ont un rebord qui donnera sécurité au contenu de l'étagère en empêchant les possibles déversements. Ces détails de fabrication fournissent fermeté et sécurité à toute la structure.

015400 44

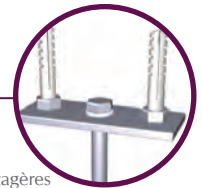

Kit de fijación a techo para estanterías suspendidas
Ceiling fixing kit for hanging shelves
Kit de montage pour plafond pour étagères suspendues



081802 25 431

Porta-notas mural
Wall mounted note-holder
Porte-notes mural

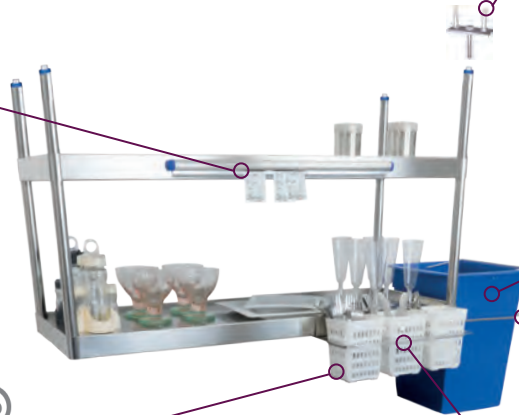

486024 18 373

Contenedor de desperdicios y reciclaje
Waste and recycling container
Conteneur à ordures et recyclage

276044 32 312

Adaptador contenedor desperdicios
Cutlery basket adaptor for service trolleys
Adaptateur de conteneurs pour chariots de service

454860 3,00 430

Cestillo para cubiertos
Cutlery basket
Couverts panier

276042 26 312

Adaptador de cestillos cuberteros
Container adaptor for service trolleys
Adaptateur de panier à utensiles de cuisine pour chariots de service

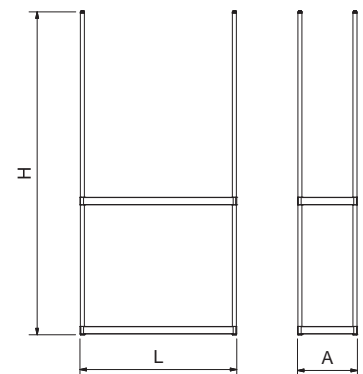

Posibilidad de añadir estantes adicionales.
Preparado para atornillar mediante taco expansor.

L	A	H	Kg	Barcode	€	Kg	Barcode	€
991	391	2.000	8,0	015402	310,00	3,6	276060	100,00
1.391	391	2.000	10,6	015404	375,00	4,9	276062	125,00
1.891	391	2.000	13,8	015406	450,00	6,5	276064	150,00

Incluido / Included / Inclus

Opcional / Optional / Optionnel

Estanterías de sobremesa
 Desktop shelves
 Étagères à poser sur table

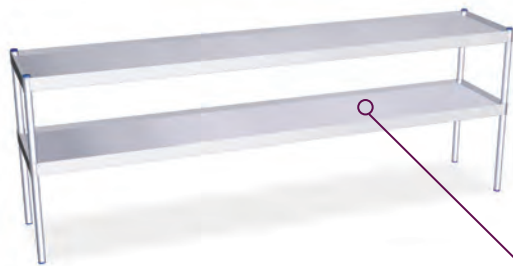

Estantes regulables en altura
 Adjustable shelves
 Étagères réglables en hauteur

Entrepañó opcional
 Optional shelf
 Tablette en option **Op**



081802 € 25 431 **Op**

Porta-notas mural
 Wall mounted note-holder
 Porte-notes mural



085014 € 8 **Op**

Kit de fijación
 Fixing kit
 Kit de fixation

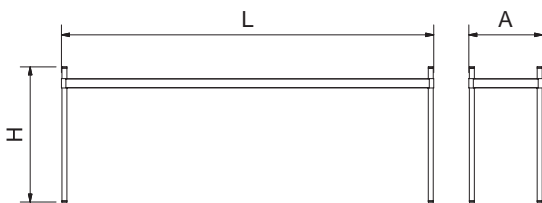

Instalación de sobremesa con o sin fijación.
 Installation on worktop with or without attachment.
 Installation sur dessus avec ou sans fixation.

L	A	H	Kg	Barcode	€	Kg	Barcode	€
991	391	677	3,8	076060	200,00	3,6	276060	100,00
1.391	391	677	5,1	076062	250,00	4,9	276062	125,00
1.891	391	677	6,7	076064	300,00	6,5	276064	150,00

In Incluido / Included / Inclus

Op Opcional / Optional / Optionnel

Cuadro comparativo de estantes murales con cartelas

Comparative view of wall shelves with brackets
Tableau comparatif d'étagères murales avec équères

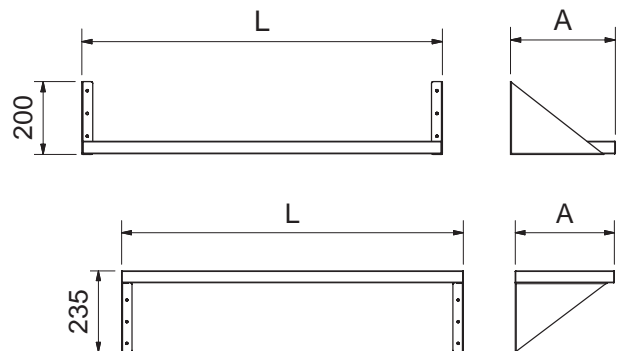
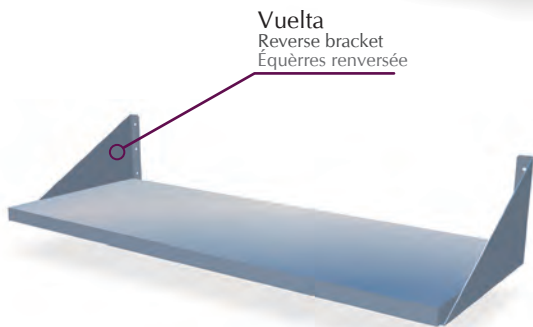
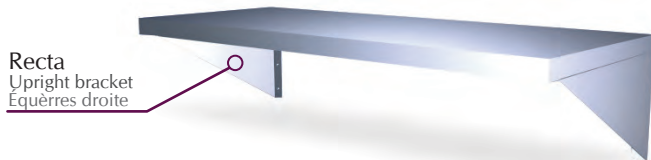

Estos estantes se suelen atornillar a la pared con nuestro tornillo cód. 421034 y con el taco cód. 409824. Ver página 69.

These shelves generally use our bolt code 421034 and our plug code 409824. See page 69.

Généralement, ces étagères utilisent notre vis code 421034 et notre cheville code 409824. Voir page 69.



Tornillos y tacos no incluidos en el precio.
Bolts and plugs not included in the price.
Les vises et les chevilles ne sont pas inclus dans le prix.

L	A	€
800	300	78,00
1.000	300	83,00
1.200	300	89,00
1.400	300	96,00
800	400	90,00
1.000	400	96,00
1.200	400	102,00
1.400	400	106,00
800	500	108,00
1.000	500	112,00
1.200	500	119,00
1.400	500	123,00

Estantes murales

Wall shelves
Etagères murales

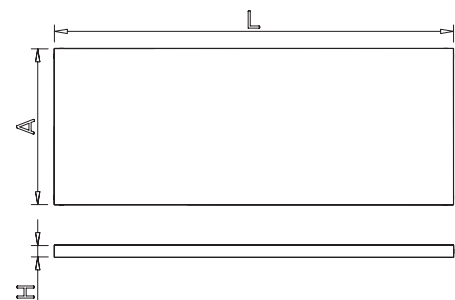
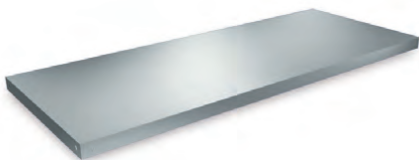

L	A	H	Kg	Barcode	€
800	300	35	2,20	011602	46,00
1.000	300	35	2,78	011604	51,00
1.200	300	35	3,24	011606	57,00
1.400	300	35	3,76	011608	64,00
600	400	35	2,50	011609	53,00
800	400	35	2,76	011610	54,00
1.000	400	35	3,40	011612	60,00
1.200	400	35	4,04	011614	66,00
1.400	400	35	4,76	011616	70,00
800	500	35	3,36	011618	68,00
1.000	500	35	4,14	011620	72,00
1.200	500	35	4,90	011622	79,00
1.400	500	35	5,56	011624	83,00
800	600	35	3,95	011626	82,00
1.000	600	35	4,85	011628	84,00
1.200	600	35	5,75	011630	92,00
1.400	600	35	6,65	011632	96,00

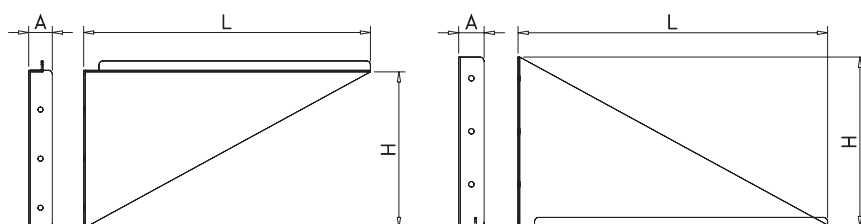
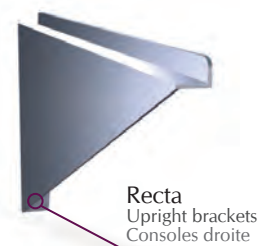

L	A	H	Gr	Barcode 1	Barcode 2	Barcode 3	Barcode 4	€
265	20	200	500	012402	012403	012602	012603	16,00
365	20	200	700	012404	012405	012604	012605	18,00
465	20	200	850	012406	012407	012606	012607	20,00

Estantes de suelo
Floor shelves
Étagères au sol

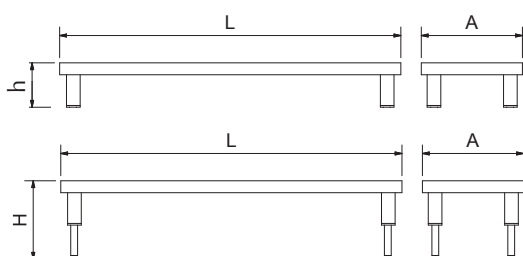
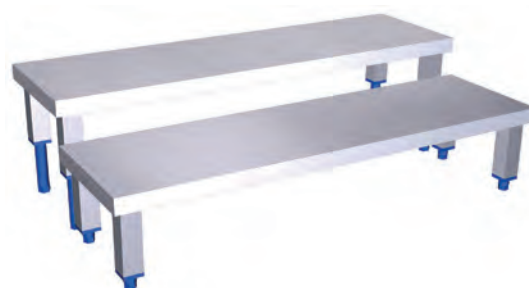

L	A	h	H	Kg	Barcode	€
800	300	130	230	2,8	082002	110,00
1.000	300	130	230	3,4	082004	115,00
1.200	300	130	230	3,9	082006	120,00
1.400	300	130	230	4,4	082008	131,00
600	400	130	230	2,8	082018	85,00
800	400	130	230	3,4	082010	120,00
1.000	400	130	230	4,0	082012	127,00
1.200	400	130	230	4,7	082014	131,00
1.400	400	130	230	5,4	082016	146,00

Diseñados para lugares donde no se permite el almacenamiento directamente en el suelo.

También válidos para mejorar la exposición de las carnes y embutidos dentro de los mostradores frigoríficos estándar. Su diversidad de medidas facilitan su adaptación a cualquier modelo de expositor. Construidos en chapa de acero inoxidable que, además de garantizar al máximo su duración, es totalmente higiénico y favorece la distribución del frío. Provistos de pies regulables en altura.

Intended for places where storage directly on the floor is not allowed.

Also valid for improve the display of meat and sausage on the stands of standar fridges. Its diversity of sizes make easier the adaptation at any model of stand. Constructed in stainless steel sheet that guarantees the maximum lenght and furthermore favours the cold distribution.

Fabriquées pour les lieux où le stockage directement au sol n'est pas permis.

Valables également pour améliorer l'exposition des viandes et des charcuteries dans les comptoirs frigorifiques standard. Sa diversité de dimensions facilitent sa adaptation a quelque modèle de comptoir. Construit en plaque d'acier inoxydable, laquel en plus de garantir au maximum sa durée, c'est totalement hygiénique et favorise la distribution du froid. Pourvu de pieds réglables en hauteur.

Estante mural porta-barquetas

Wall shelf for meat plastic trays
Étagère murale porte-barquettes alimentaires



Estos estantes se suelen atornillar a la pared con nuestro tornillo cód. 421034 y con el taco cód. 409824. Ver página 69.

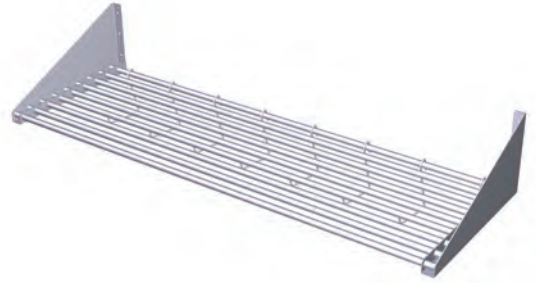

These shelves generally use our bolt code 421034 and our plug code 409824. See page 69.

Généralement, cet étagères utilisent notre vis code 421034 et notre cheville code 409824. Voir page 69.



Tornillos y tacos no incluidos en el precio.
Bolts and plugs not included in the price.
Les vises et les chevilles ne sont pas inclus dans le prix.

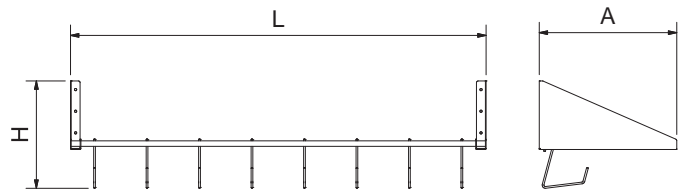

L	A	H	Nº Ganchos Hooks Crochets	Kg	Barcode	€
1.200	400	310	8	6,80	011920	168,00

Estante mural de fibra abatible

Polyethylene hinged wall shelf
Console murale battante en polyéthylène



Estos estantes se suelen atornillar a la pared con nuestro tornillo cód. 421034 y con el taco cód. 409824. Ver página 69.



421254 47,00 56

Cartelas abatibles para estantes murales.
Hinged bracket for wall shelf.
Équerre battante pour étagère murale.

These shelves generally use our bolt code 421034 and our plug code 409824. See page 69.

Généralement, cet étagères utilisent notre vis code 421034 et notre cheville code 409824. Voir page 69.

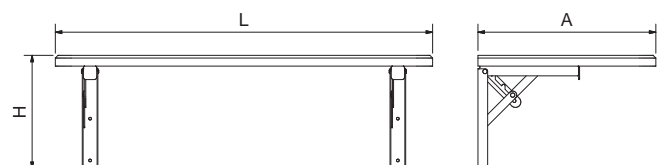

L	A	H	Kg	Barcode	€
700	330	205	2,00	013206	180,00





Tornillos y tacos no incluidos en el precio.
Bolts and plugs not included in the price.
Les vises et les chevilles ne sont pas inclus dans le prix.

Estante mural inclinado para cestas de lavavajillas

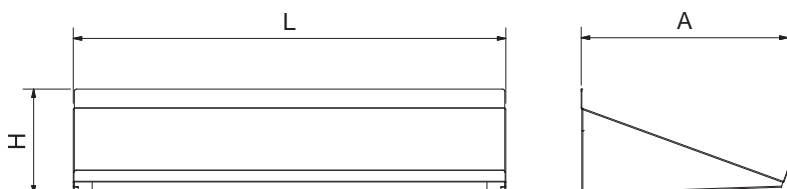
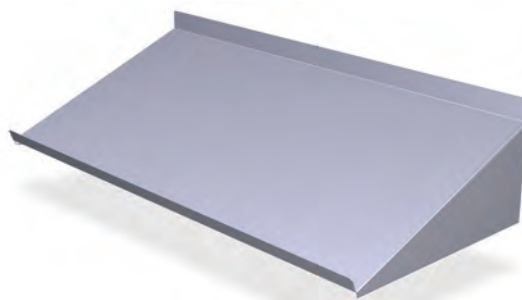
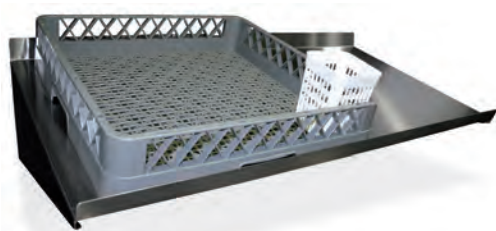
Sloping inclined wall rack shelf
Étagère murale inclinée pour paniers de lavage



L	A	H				€
1.020	488	248	500x500	8,70	011430	160,00
1.550	488	248	500x500	12,50	011432	195,00

Características:

Este taburete metálico lleva en su base tres ruedas que permiten su fácil traslado de un sitio a otro con un simple empujón del pie. Sin embargo, en el momento en que usted sube sobre él queda totalmente fijado al suelo gracias a su burlete circular que se adhiere como una ventosa.





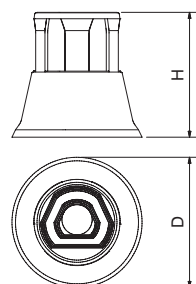

Disponible en otros colores a partir de 24 unidades.

Characteristics:

This metallic stool has on its base three castors that allow moving it from one place to another easily, just pushing it with your foot. Furthermore, whenever you are standing on it, it is firmly fixed to the floor, as if it were a suction pad, thanks to its rounded rubber strip.

Available in other colors. From 24 units.



D	H				€
				482202	
430	430	4,6		482204	55,00
				482210	



Taburete con ruedas

Rolling step-stool
Tabouret marche - pied roulant



 €
482250 5,80

Rueda de repuesto para taburetes.
Spare wheel for step-stools.
Rouelle de rechange pour tabouretes.



Caractéristiques:

Ce tabouret métallique a dans sa base trois rouelles qui permettent le déplacer facilement de long en large, avec un seul poussé du pied. En plus, lorsqu'on monte sur lui, il reste totalement fixé au sol, comme une ventouse, grâce à sa bande ronde en caoutchouc.

Disponible dans d'autres couleurs. A partir de 24 unités.



Optimice su espacio con esta nueva estación de trabajo

imagine GN es una nueva herramienta pensada para optimizar el espacio de trabajo. Este innovador sistema emplea un diseño Cantilever que elimina los soportes frontales, incrementando hasta un 40% más el espacio útil de trabajo dentro de la misma zona.

Se instala con facilidad y rapidez. Basado en las dimensiones internacionales GASTRONORM, está fabricado totalmente en acero inoxidable, con un diseño moderno y único.

imagine GN lo podrá utilizar para almacenamiento tanto en lugares secos como en ambientes con humedad, cocinas industriales, salas de preparación y elaboración de alimentos, laboratorios, clínicas, talleres, estaciones de servicio, etc.

Con las soluciones modulares imagine GN puede configurar fácil y rápidamente su espacio de trabajo atendiendo a las necesidades de cambio.



Puede regular la altura (cada 140 mm.) y la inclinación de los estantes sin usar herramientas. Shelves height (every 140 mm.) and lean can be adjusted without using any tool. Vous pouvez régler l' hauteur (tous 140 mm.) et l' inclination des étagères sans utiliser des outils.

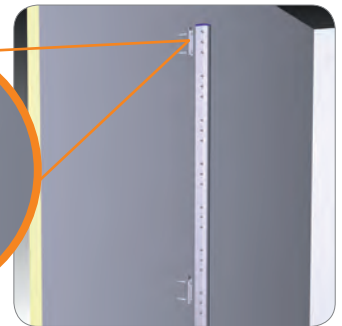
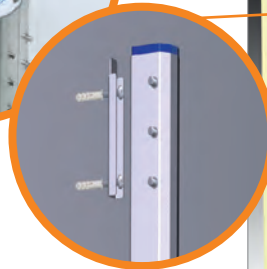

imagine GN Optimize your space with this innovative work station.

imagine GN is a new tool, thought to optimize your work room. This innovative system employs a Cantilever design that eliminates the front supports, increasing up to a 40% the useful surface within the work area.

You can mount it easily and quickly. Based in the international dimensions GASTRONORM, it is made totally in stainless steel, with a modern and unique design.

imagine GN can be used to stock in dry areas as well as in places with wet atmosphere, industrial kitchens, food preparation rooms, laboratories, clinics, garages, petrol stations, etc.

With the imagine GN modular solutions you can easily and quickly design your working area meeting at the same time your needs of change.

Now with imagine GN you will be able to re-design your work area whenever it is necessary.

LAS NECESIDADES CAMBIAN

Needs change
Les besoins changent



Detalle de fijación a pared. Wall fixing detail. Détails de fixation murale.

Video



Ahora con imagine GN podrá rediseñar su espacio de trabajo cuando sea necesario.

imagine GN Optimisez votre espace avec cette nouvelle station de travail.

imagine GN, c' est un nouveau outil conçu pour optimiser l' espace de travail. Cette innovateur système emploie un dessin Cantilever qu' évite des supports frontaux, et c' est ainsi qu' on augmente la surface utile dans le zone de travail.

On l' installe facilement et rapidement. Dessinée sur les dimensions internationales Gastronorm, elle est fabriquée totalement en acier inoxydable avec une finition moderne et unique.

imagine GN, vous pouvez l' utiliser pour le stockage tandis dans endroits secs comme dans endroits avec atmosphère humide, cuisines industrielles, salles de préparation des aliments, laboratoires, cliniques, ateliers, stations-service, etc.

Avec les solutions modulaires imagine GN vous pouvez configurer facile et rapidement votre espace de travail en tenant en compte au même temps votre besoins d' échange.



Maintenant avec imagine GN vous pourrez re-dessiner votre espace quand il soit nécessaire.

			1/1 A = 413 mm			2/1 A = 614 mm			
			Número de estantes			Número de estantes			
			Number of shelves			Number of shelves			
			Numéro d'étagères			Numéro d'étagères			
mm			3	4	5	Composición Set Set			
L	H	Composición Set Set	€	€	€	€	€	€	
764	1.700	1A	541,20	662,20	783,20	1D	600,60	741,40	882,20
1.174	1.700	1B	613,80	759,00	904,20	1E	699,60	873,40	1.047,20
1.414	1.700	1C	719,40	899,80	1.080,20	1F	805,20	1.014,20	1.223,20
1.475	1.700	1A+1a	920,70	1.138,50	1.356,30	1D+1d	1.023,00	1.274,90	1.526,80
1.885	1.700	1A+1b	993,30	1.235,30	1.477,30	1D+1e	1.122,00	1.406,90	1.691,80
2.125	1.700	1A+1c	1.098,90	1.376,10	1.653,30	1D+1f	1.227,60	1.547,70	1.867,80
2.186	1.700	1A+2a	1.300,20	1.614,80	1.929,40	1D+2d	1.445,40	1.808,40	2.171,40
2.295	1.700	1B+1b	1.065,90	1.332,10	1.598,30	1E+1e	1.221,00	1.538,90	1.856,80
2.535	1.700	1B+1c	1.171,50	1.472,90	1.774,30	1E+1f	1.326,60	1.679,70	2.032,80
2.596	1.700	1B+2a	1.372,80	1.711,60	2.050,40	1E+2d	1.544,40	1.940,40	2.336,40
2.775	1.700	1C+1c	1.277,10	1.613,70	1.950,30	1F+1f	1.432,20	1.820,50	2.208,80
2.836	1.700	1C+2a	1.478,40	1.852,40	2.226,40	1F+2d	1.650,00	2.081,20	2.512,40
2.897	1.700	1A+3a	1.679,70	2.091,10	2.502,50	1D+3d	1.867,80	2.341,90	2.816,00
3.006	1.700	1A+2b	1.445,40	1.808,40	2.171,40	1D+2e	1.643,40	2.072,40	2.501,40
3.246	1.700	1A+1b+1c	1.551,00	1.949,20	2.347,40	1D+1e+1f	1.749,00	2.213,20	2.677,40
3.307	1.700	1B+3a	1.752,30	2.187,90	2.623,50	1E+3d	1.966,80	2.473,90	2.981,00
3.416	1.700	1B+2b	1.518,00	1.905,20	2.292,40	1E+2e	1.742,40	2.204,40	2.666,40
3.486	1.700	1A+2c	1.656,60	2.090,00	2.523,40	1D+2f	1.854,60	2.354,00	2.853,40
3.547	1.700	1C+3a	1.857,90	2.328,70	2.799,50	1F+3d	2.072,40	2.614,70	3.157,00
3.608	1.700	1A+4a	2.059,20	2.567,40	3.075,60	1D+4d	2.290,20	2.875,40	3.460,60
3.656	1.700	1C+2b	1.623,60	2.046,00	2.468,40	1F+2e	1.848,00	2.345,20	2.842,40
3.717	1.700	1A+1a+2b	1.824,90	2.284,70	2.744,50	1D+1d+2e	2.065,80	2.605,90	3.146,00
3.896	1.700	1B+2c	1.729,20	2.186,80	2.644,40	1E+2f	1.953,60	2.486,00	3.018,40
3.957	1.700	1B+2a+1c	1.930,50	2.425,50	2.920,50	1E+2d+1f	2.171,40	2.746,70	3.322,00
4.018	1.700	1B+4a	2.131,80	2.664,20	3.196,60	1E+4d	2.389,20	3.007,40	3.625,60
4.127	1.700	1A+3b	1.897,50	2.381,50	2.865,50	1D+3e	2.164,80	2.737,90	3.311,00
4.136	1.700	1C+2c	1.834,80	2.327,60	2.820,40	1F+2f	2.059,20	2.626,80	3.194,40
4.197	1.700	1A+1a+2c	2.036,10	2.566,30	3.096,50	1D+1d+2f	2.277,00	2.887,50	3.498,00
4.258	1.700	1C+4a	2.237,40	2.805,00	3.372,60	1F+4d	2.494,80	3.148,20	3.801,60
4.319	1.700	1A+5a	2.438,70	3.043,70	3.648,70	1D+5d	2.712,60	3.408,90	4.105,20
4.367	1.700	1A+2b+1c	2.003,10	2.522,30	3.041,50	1D+2e+1f	2.270,40	2.878,70	3.487,00
4.428	1.700	1A+2a+2b	2.204,40	2.761,00	3.317,60	1D+2d+2e	2.488,20	3.139,40	3.790,60
4.537	1.700	1B+3b	1.970,10	2.478,30	2.986,50	1E+3e	2.263,80	2.869,90	3.476,00
4.607	1.700	1A+1B+2c	2.108,70	2.663,10	3.217,50	1D+1E+2f	2.376,00	3.019,50	3.663,00
4.668	1.700	1B+3a+1c	2.310,00	2.901,80	3.493,60	1E+3d+1f	2.593,80	3.280,20	3.966,60
4.729	1.700	1B+5a	2.511,30	3.140,50	3.769,70	1E+5d	2.811,60	3.540,90	4.270,20
4.777	1.700	1C+3b	2.075,70	2.619,10	3.162,50	1F+3e	2.369,40	3.010,70	3.652,00
4.838	1.700	1A+1a+3b	2.277,00	2.857,80	3.438,60	1D+1d+3e	2.587,20	3.271,40	3.955,60
4.847	1.700	1A+3c	2.214,30	2.803,90	3.393,50	1D+3f	2.481,60	3.160,30	3.839,00
4.908	1.700	1A+2a+2c	2.415,60	3.042,60	3.669,60	1D+2d+2f	2.699,40	3.421,00	4.142,60
4.969	1.700	1C+5a	2.616,90	3.281,30	3.945,70	1F+5d	2.917,20	3.681,70	4.446,20
5.017	1.700	1B+1b+2c	2.181,30	2.759,90	3.338,50	1E+1e+2f	2.475,00	3.151,50	3.828,00
5.030	1.700	1A+6a	2.818,20	3.520,00	4.221,80	1D+6d	3.135,00	3.942,40	4.749,80
5.078	1.700	1C+2a+2b	2.382,60	2.998,60	3.614,60	1F+2d+2e	2.692,80	3.412,20	4.131,60
5.139	1.700	1A+3a+2b	2.583,90	3.237,30	3.890,70	1D+3d+2e	2.910,60	3.672,90	4.435,20
5.248	1.700	1A+4b	2.349,60	2.954,60	3.559,60	1D+4e	2.686,20	3.403,40	4.120,60
5.257	1.700	1B+3c	2.286,90	2.900,70	3.514,50	1E+3f	2.580,60	3.292,30	4.004,00
5.318	1.700	1B+2a+2c	2.488,20	3.139,40	3.790,60	1E+2d+2f	2.798,40	3.553,00	4.307,60

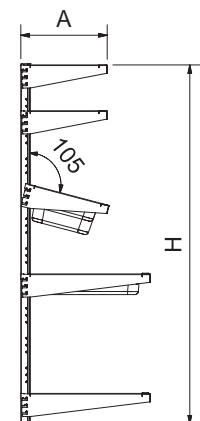
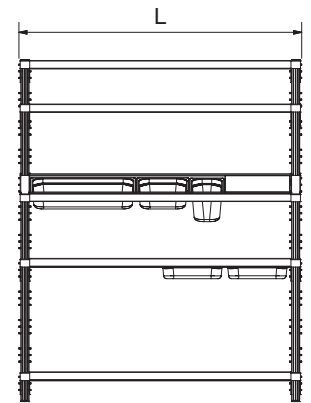

Composiciones básicas sistema imagine mural suspendida

Basic combinations of the imagine hanging wall shelf system
 Combinaisons basiques du système murale suspendue imagine



A, B, C, D, E, F

Las composiciones básicas imagine cuentan con todos los elementos necesarios para su montaje individual.

They are basic structures of the wall-side system imagine GN, and they are fully equipped for their individual assembly.

Elles sont structures basiques du système mural imagine, et sont pourvues avec tous les éléments nécessaires pour son montage individuel.

a, b, c, d, e, f

Cuentan con los elementos necesarios para prolongar las composiciones básicas imagine. Se deben pedir únicamente con ese fin, pues no podrían montarse por sí mismas al faltarles pies, soportes, cartelas, etc.

They are the necessary elements to extend the basic structures imagine. They are complementary and can only be installed together with the basic structures.

Ils sont des éléments nécessaires pour prolonger les structures basiques imagine. Ils sont complémentaires et seulement peuvent être installés conjointement avec ces structures basiques.

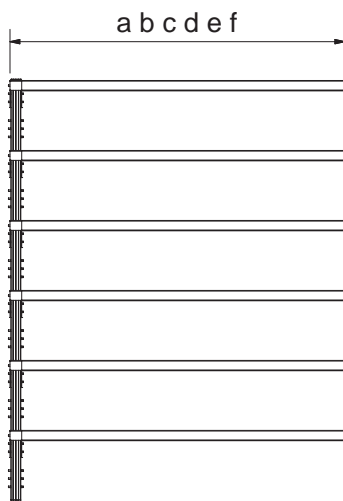
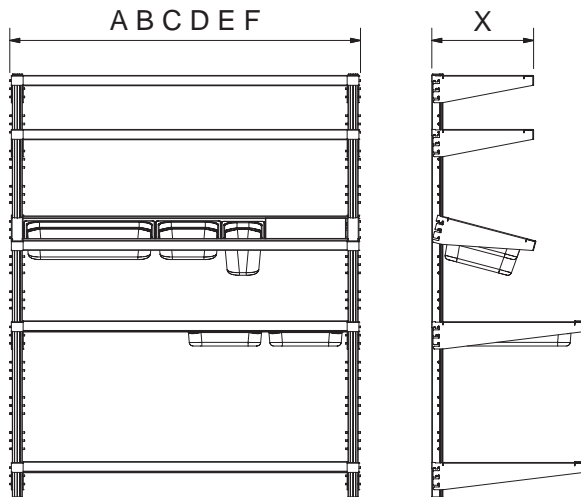

Prolongación de composiciones básicas
 Extended basic structures
 Structures basiques prolongées

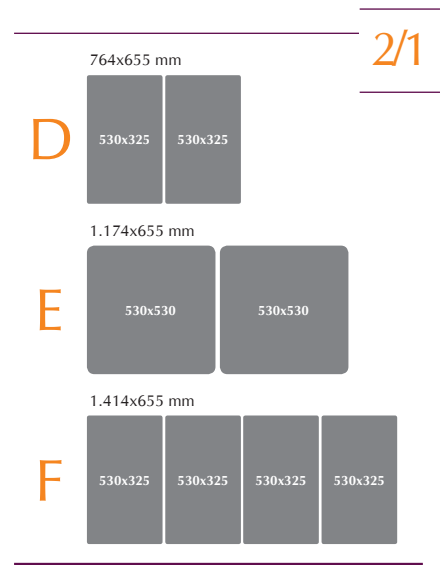
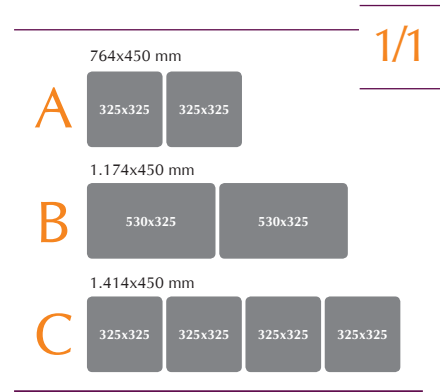

		Número de estantes Number of shelves Numéro d'étagères			
		3	4	5	
↔	X	€	€	€	
A	764	413	541,20	662,20	783,20
a	711	413	379,50	476,30	573,10
B	1.174	413	613,80	759,00	904,20
b	1.121	413	452,10	573,10	694,10
C	1.414	413	719,40	899,80	1.080,20
c	1.361	413	557,70	713,90	870,10
D	764	614	600,60	741,40	882,20
d	711	614	422,40	533,50	644,60
E	1.174	614	699,60	873,40	1.047,20
e	1.121	614	521,40	665,50	809,60
F	1.414	614	805,20	1.014,20	1.223,20
f	1.361	614	627,00	806,30	985,60

mm		1/1 A = 451 mm Número de estantes Number of shelves Número d'étagères			2/1 A = 656 mm Número de estantes Number of shelves Número d'étagères				
L	H	Composición Set Set	3 €	4 €	5 €	Composición Set Set	3 €	4 €	5 €
764	1.700	1A	800,80	921,80	1.042,80	1D	893,20	1.034,00	1.174,80
1.174	1.700	1B	884,40	1.029,60	1.174,80	1E	1.003,20	1.177,00	1.350,80
1.414	1.700	1C	1.005,40	1.185,80	1.366,20	1F	1.124,20	1.333,20	1.542,20
1.475	1.700	1A+1a	1.329,90	1.547,70	1.765,50	1D+1d	1.481,70	1.733,60	1.985,50
1.885	1.700	1A+1b	1.413,50	1.655,50	1.897,50	1D+1e	1.591,70	1.876,60	2.161,50
2.125	1.700	1A+1c	1.534,50	1.811,70	2.088,90	1D+1f	1.712,70	2.032,80	2.352,90
2.186	1.700	1A+2a	1.859,00	2.173,60	2.488,20	1D+2d	2.070,20	2.433,20	2.796,20
2.295	1.700	1B+1b	1.497,10	1.763,30	2.029,50	1E+1e	1.701,70	2.019,60	2.337,50
2.535	1.700	1B+1c	1.618,10	1.919,50	2.220,90	1E+1f	1.822,70	2.175,80	2.528,90
2.596	1.700	1B+2a	1.942,60	2.281,40	2.620,20	1E+2d	2.180,20	2.576,20	2.972,20
2.775	1.700	1C+1c	1.739,10	2.075,70	2.412,30	1F+1f	1.943,70	2.332,00	2.720,30
2.836	1.700	1C+2a	2.063,60	2.437,60	2.811,60	1F+2d	2.301,20	2.732,40	3.163,60
2.897	1.700	1A+3a	2.388,10	2.799,50	3.210,90	1D+3d	2.658,70	3.132,80	3.606,90
3.006	1.700	1A+2b	2.026,20	2.389,20	2.752,20	1D+2e	2.290,20	2.719,20	3.148,20
3.246	1.700	1A+1b+1c	2.147,20	2.545,40	2.943,60	1D+1e+1f	2.411,20	2.875,40	3.339,60
3.307	1.700	1B+3a	2.471,70	2.907,30	3.342,90	1E+3d	2.768,70	3.275,80	3.782,90
3.416	1.700	1B+2b	2.109,80	2.497,00	2.884,20	1E+2e	2.400,20	2.862,20	3.324,20
3.486	1.700	1A+2c	2.268,20	2.701,60	3.135,00	1D+2f	2.532,20	3.031,60	3.531,00
3.547	1.700	1C+3a	2.592,70	3.063,50	3.534,30	1F+3d	2.889,70	3.432,00	3.974,30
3.608	1.700	1A+4a	2.917,20	3.425,40	3.933,60	1D+4d	3.247,20	3.832,40	4.417,60
3.656	1.700	1C+2b	2.230,80	2.653,20	3.075,60	1F+2e	2.521,20	3.018,40	3.515,60
3.717	1.700	1A+1a+2b	2.555,30	3.015,10	3.474,90	1D+1d+2e	2.878,70	3.418,80	3.958,90
3.896	1.700	1B+2c	2.351,80	2.809,40	3.267,00	1E+2f	2.642,20	3.174,60	3.707,00
3.957	1.700	1B+2a+1c	2.676,30	3.171,30	3.666,30	1E+2d+1f	2.999,70	3.575,00	4.150,30
4.018	1.700	1B+4a	3.000,80	3.533,20	4.065,60	1E+4d	3.357,20	3.975,40	4.593,60
4.127	1.700	1A+3b	2.638,90	3.122,90	3.606,90	1D+3e	2.988,70	3.561,80	4.134,90
4.136	1.700	1C+2c	2.472,80	2.965,60	3.458,40	1F+2f	2.763,20	3.330,80	3.898,40
4.197	1.700	1A+1a+2c	2.797,30	3.327,50	3.857,70	1D+1d+2f	3.120,70	3.731,20	4.341,70
4.258	1.700	1C+4a	3.121,80	3.689,40	4.257,00	1F+4d	3.478,20	4.131,60	4.785,00
4.319	1.700	1A+5a	3.446,30	4.051,30	4.656,30	1D+5d	3.835,70	4.532,00	5.228,30
4.367	1.700	1A+2b+1c	2.759,90	3.279,10	3.798,30	1D+2e+1f	3.109,70	3.718,00	4.326,30
4.428	1.700	1A+2a+2b	3.084,40	3.641,00	4.197,60	1D+2d+2e	3.467,20	4.118,40	4.769,60
4.537	1.700	1B+3b	2.722,50	3.230,70	3.738,90	1E+3e	3.098,70	3.704,80	4.310,90
4.607	1.700	1A+1B+2c	2.880,90	3.435,30	3.989,70	1D+1E+2f	3.230,70	3.874,20	4.517,70
4.668	1.700	1B+3a+1c	3.205,40	3.797,20	4.388,90	1E+3d+1f	3.588,20	4.274,60	4.961,00
4.729	1.700	1B+5a	3.529,90	4.159,10	4.788,30	1E+5d	3.945,70	4.675,00	5.404,30
4.777	1.700	1C+3b	2.843,50	3.386,90	3.930,30	1F+3e	3.219,70	3.861,00	4.502,30
4.838	1.700	1A+1a+3b	3.168,00	3.748,80	4.329,60	1D+1d+3e	3.577,20	4.261,40	4.945,60
4.847	1.700	1A+3c	3.001,90	3.591,50	4.181,10	1D+3f	3.351,70	4.030,40	4.709,10
4.908	1.700	1A+2a+2c	3.326,40	3.953,40	4.580,40	1D+2d+2f	3.709,20	4.430,80	5.152,40
4.969	1.700	1C+5a	3.650,90	4.315,30	4.979,70	1F+5d	4.066,70	4.831,20	5.595,70
5.017	1.700	1B+1b+2c	2.964,50	3.543,10	4.121,70	1E+1e+2f	3.340,70	4.017,20	4.693,70
5.030	1.700	1A+6a	3.975,40	4.677,20	5.379,00	1D+6d	4.424,20	5.231,60	6.039,00
5.078	1.700	1C+2a+2b	3.289,00	3.905,00	4.521,00	1F+2d+2e	3.698,20	4.417,60	5.137,00
5.139	1.700	1A+3a+2b	3.613,50	4.266,90	4.920,30	1D+3d+2e	4.055,70	4.818,00	5.580,30
5.248	1.700	1A+4b	3.251,60	3.856,60	4.461,60	1D+4e	3.687,20	4.404,40	5.121,60
5.257	1.700	1B+3c	3.085,50	3.699,30	4.313,10	1E+3f	3.461,70	4.173,40	4.885,10
5.318	1.700	1B+2a+2c	3.410,00	4.061,20	4.712,40	1E+2d+2f	3.819,20	4.573,80	5.328,40

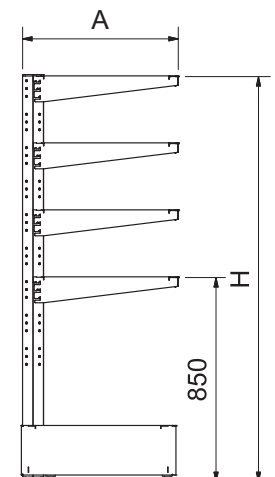
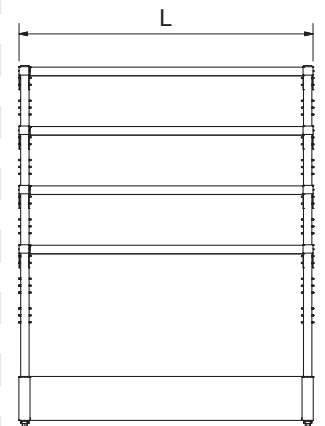

Cuadro comparativo de estanterías imagine central

Comparative chart of center imagine units
Tableau comparatif d'étagères imagine centrales

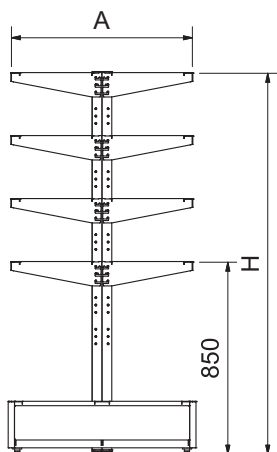
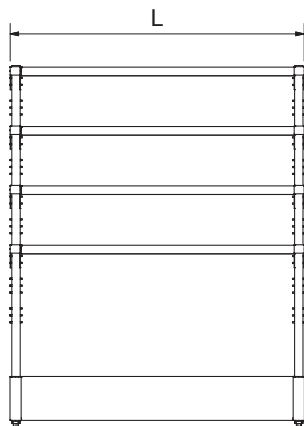

			1/1 A = 850 mm Número de estantes Number of shelves Numéro d'étagères			2/1 A = 1.255 mm Número de estantes Number of shelves Numéro d'étagères			
mm		Composición Set Set	3	4	5	Composición Set Set	3	4	5
L	H		€	€	€		€	€	€
764	1.700	1L	1.236,40	1.478,40	1.720,40	1P	1.498,20	1.779,80	2.061,40
1.174	1.700	1M	1.403,60	1.694,00	1.984,40	1Q	1.718,20	2.065,80	2.413,40
1.414	1.700	1N	1.645,60	2.006,40	2.367,20	1R	1.960,20	2.378,20	2.796,20
1.475	1.700	1L+1l	2.112,00	2.547,60	2.983,20	1P+1p	2.531,10	3.034,90	3.538,70
1.885	1.700	1L+1m	2.279,20	2.763,20	3.247,20	1P+1q	2.751,10	3.320,90	3.890,70
2.125	1.700	1L+1n	2.521,20	3.075,60	3.630,00	1P+1r	2.993,10	3.633,30	4.273,50
2.186	1.700	1L+2l	2.987,60	3.616,80	4.246,00	1P+2p	3.564,00	4.290,00	5.016,00
2.295	1.700	1M+1m	2.446,40	2.978,80	3.511,20	1Q+1q	2.971,10	3.606,90	4.242,70
2.535	1.700	1M+1n	2.688,40	3.291,20	3.894,00	1Q+1r	3.213,10	3.919,30	4.625,50
2.596	1.700	1M+2l	3.154,80	3.832,40	4.510,00	1Q+2p	3.784,00	4.576,00	5.368,00
2.775	1.700	1N+1n	2.930,40	3.603,60	4.276,80	1R+1r	3.455,10	4.231,70	5.008,30
2.836	1.700	1N+2l	3.396,80	4.144,80	4.892,80	1R+2p	4.026,00	4.888,40	5.750,80
2.897	1.700	1L+3l	3.863,20	4.686,00	5.508,80	1P+3p	4.596,90	5.545,10	6.493,30
3.006	1.700	1L+2m	3.322,00	4.048,00	4.774,00	1P+2q	4.004,00	4.862,00	5.720,00
3.246	1.700	1L+1m+1n	3.564,00	4.360,40	5.156,80	1P+1q+1r	4.246,00	5.174,40	6.102,80
3.307	1.700	1M+3l	4.030,40	4.901,60	5.772,80	1Q+3p	4.816,90	5.831,10	6.845,30
3.416	1.700	1M+2m	3.489,20	4.263,60	5.038,00	1Q+2q	4.224,00	5.148,00	6.072,00
3.486	1.700	1L+2n	3.806,00	4.672,80	5.539,60	1P+2r	4.488,00	5.486,80	6.485,60
3.547	1.700	1N+3l	4.272,40	5.214,00	6.155,60	1R+3p	5.058,90	6.143,50	7.228,10
3.608	1.700	1L+4l	4.738,80	5.755,20	6.771,60	1P+4p	5.629,80	6.800,20	7.970,60
3.656	1.700	1N+2m	3.731,20	4.576,00	5.420,80	1R+2q	4.466,00	5.460,40	6.454,80
3.717	1.700	1L+1l+2m	4.197,60	5.117,20	6.036,80	1P+1p+2q	5.036,90	6.117,10	7.197,30
3.896	1.700	1M+2n	3.973,20	4.888,40	5.803,60	1Q+2r	4.708,00	5.772,80	6.837,60
3.957	1.700	1M+2l+1n	4.439,60	5.429,60	6.419,60	1Q+2p+1r	5.278,90	6.429,50	7.580,10
4.018	1.700	1M+4l	4.906,00	5.970,80	7.035,60	1Q+4p	5.849,80	7.086,20	8.322,60
4.127	1.700	1L+3m	4.364,80	5.332,80	6.300,80	1P+3q	5.256,90	6.403,10	7.549,30
4.136	1.700	1N+2n	4.215,20	5.200,80	6.186,40	1R+2r	4.950,00	6.085,20	7.220,40
4.197	1.700	1L+1l+2n	4.681,60	5.742,00	6.802,40	1P+1p+2r	5.520,90	6.741,90	7.962,90
4.258	1.700	1N+4l	5.148,00	6.283,20	7.418,40	1R+4p	6.091,80	7.398,60	8.705,40
4.319	1.700	1L+5l	5.614,40	6.824,40	8.034,40	1P+5p	6.662,70	8.055,30	9.447,90
4.367	1.700	1L+2m+1n	4.606,80	5.645,20	6.683,60	1P+2q+1r	5.498,90	6.715,50	7.932,10
4.428	1.700	1L+2l+2m	5.073,20	6.186,40	7.299,60	1P+2p+2q	6.069,80	7.372,20	8.674,60
4.537	1.700	1M+3m	4.532,00	5.548,40	6.564,80	1Q+3q	5.476,90	6.689,10	7.901,30
4.607	1.700	1L+1M+2n	4.848,80	5.957,60	7.066,40	1P+1Q+2r	5.740,90	7.027,90	8.314,90
4.668	1.700	1M+3l+1n	5.315,20	6.498,80	7.682,40	1Q+3p+1r	6.311,80	7.684,60	9.057,40
4.729	1.700	1M+5l	5.781,60	7.040,00	8.298,40	1Q+5p	6.882,70	8.341,30	9.799,90
4.777	1.700	1N+3m	4.774,00	5.860,80	6.947,60	1R+3q	5.718,90	7.001,50	8.284,10
4.838	1.700	1L+1l+3m	5.240,40	6.402,00	7.563,60	1P+1p+3q	6.289,80	7.658,20	9.026,60
4.847	1.700	1L+3n	5.090,80	6.270,00	7.449,20	1P+3r	5.982,90	7.340,30	8.697,70
4.908	1.700	1L+2l+2n	5.557,20	6.811,20	8.065,20	1P+2p+2r	6.553,80	7.997,00	9.440,20
4.969	1.700	1N+5l	6.023,60	7.352,40	8.681,20	1R+5p	7.124,70	8.653,70	10.182,70
5.017	1.700	1M+1m+2n	5.016,00	6.173,20	7.330,40	1Q+1q+2r	5.960,90	7.313,90	8.666,90
5.030	1.700	1L+6l	6.490,00	7.893,60	9.297,20	1P+6p	7.695,60	9.310,40	10.925,20
5.078	1.700	1N+2l+2m	5.482,40	6.714,40	7.946,40	1R+2p+2q	6.531,80	7.970,60	9.409,40
5.139	1.700	1L+3l+2m	5.948,80	7.255,60	8.562,40	1P+3p+2q	7.102,70	8.627,30	10.151,90
5.248	1.700	1L+4m	5.407,60	6.617,60	7.827,60	1P+4q	6.509,80	7.944,20	9.378,60
5.257	1.700	1M+3n	5.258,00	6.485,60	7.713,20	1Q+3r	6.202,90	7.626,30	9.049,70
5.318	1.700	1M+2l+2n	5.724,40	7.026,80	8.329,20	1Q+2p+2r	6.773,80	8.283,00	9.792,20

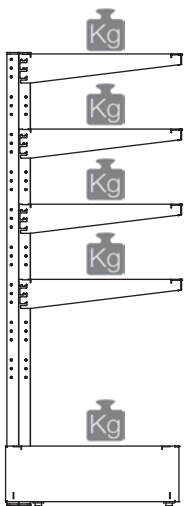
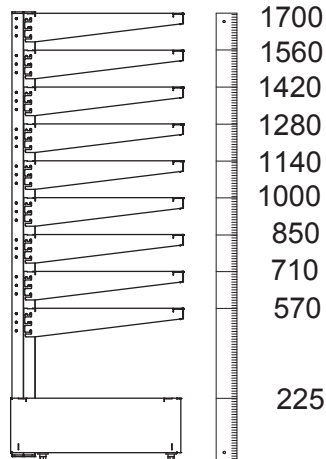
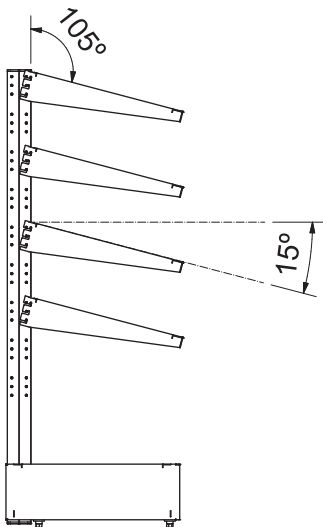

Capacidad de estantes:

Sistema mural 10 niveles por módulo.
 Sistema central 10 niveles dobles por módulo.

Shelving unit capacity:

Wall-side system – 10 levels per unit.
 Centre system – 10 double levels per unit.

Capacité des étagères:

Système mural – 10 niveaux par module.
 Système central – 10 niveaux doubles par module.

Kg = 125 Kg.

Las cargas se consideran uniformemente repartidas en la superficie del estante.
 It is assumed that loads are evenly distributed on the shelf surface.
 On considère que les charges sont réparties uniformément sur la surface de l'étagère.

Composiciones básicas sistema imagine mural

Basic structures for imagine wall-side system
Compositions basiques système imagine mural



A, B, C, D, E, F

Las composiciones básicas imagine cuentan con todos los elementos necesarios para su montaje individual.

They are basic structures of the wall-side system imagine GN, and they are fully equipped for their individual assembly.

Elles sont structures basiques du système mural imagine, et sont pourvues avec tous les éléments nécessaires pour son montage individuel.

a, b, c, d, e, f

Cuentan con los elementos necesarios para prolongar las composiciones básicas imagine. Se deben pedir únicamente con ese fin, pues no podrían montarse por sí mismas al faltarles pies, soportes, cartelas, etc.

They are the necessary elements to extend the basic structures imagine. They are complementary and can only be installed together with the basic structures.

Ils sont des éléments nécessaires pour prolonger les structures basiques imagine. Ils sont complémentaires et seulement peuvent être installés conjointement avec ces structures basiques.

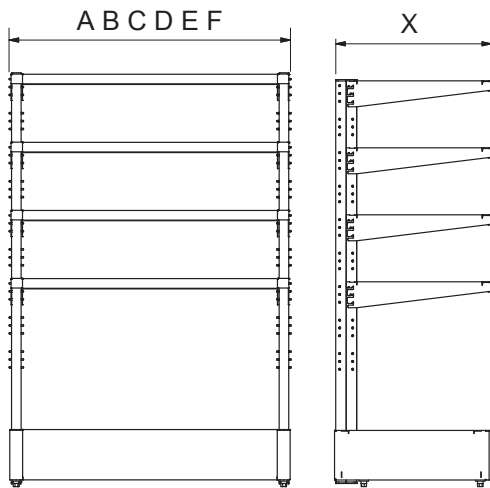

Composiciones básicas
Basic structures
Structures basiques

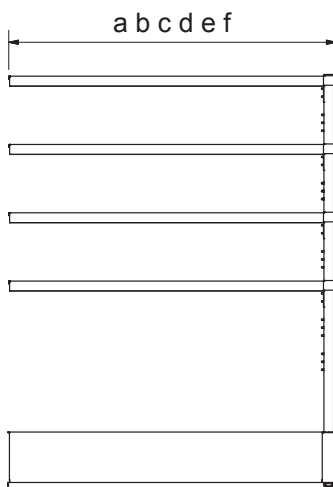

Prolongación de composiciones básicas
Extended basic structures
Structures basiques prolongées

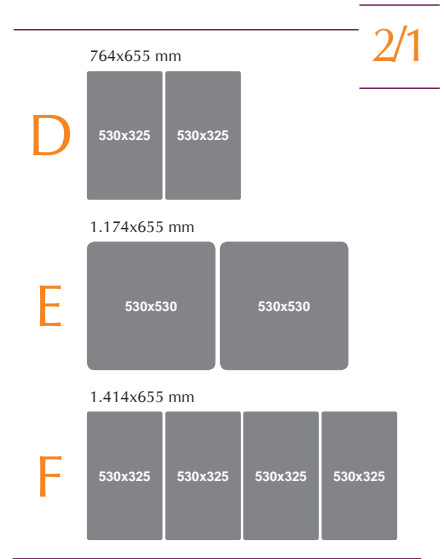
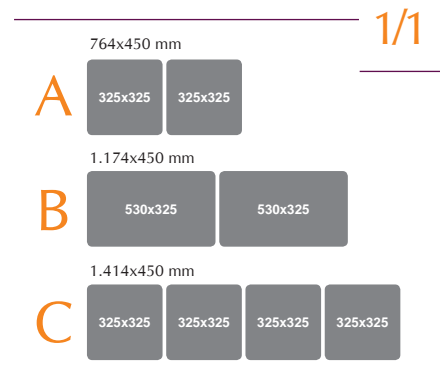

		Número de estantes Number of shelves Numéro d'étagères		
		3	4	5
↔	X	€	€	€
A	764 450	800,80	921,80	1.042,80
a	711 450	529,10	625,90	722,70
B	1.174 450	884,40	1.029,60	1.174,80
b	1.121 450	612,70	733,70	854,70
C	1.414 450	1.005,40	1.185,80	1.366,20
c	1.361 450	733,70	889,90	1.046,10
D	764 655	893,20	1.034,00	1.174,80
d	711 655	588,50	699,60	810,70
E	1.174 655	1.003,20	1.177,00	1.350,80
e	1.121 655	698,50	842,60	986,70
F	1.414 655	1.124,20	1.333,20	1.542,20
f	1.361 655	819,50	998,80	1.178,10

L, M, N, P, Q, R

Las composiciones básicas imagine cuentan con todos los elementos necesarios para su montaje individual.

They are basic structures of the wall-side system imagine, and they are fully equipped for their individual assembly.

Elles sont structures basiques du système mural imagine, et sont pourvues de tous les éléments nécessaires pour son montage individuel.

l, m, n, p, q, r

Cuentan con los elementos necesarios para prolongar las composiciones básicas imagine. Se deben pedir únicamente con ese fin, pues no podrían montarse por sí mismas al faltarles pies, soportes, cartelas, etc.

They are the necessary elements to extend the basic structures imagine GN. They are complementary and can only be installed together with the basic structures.

Ils sont des éléments nécessaires pour prolonger les structures basiques imagine GN. Ils sont complémentaires et seulement peuvent être installés conjointement avec ces structures basiques.

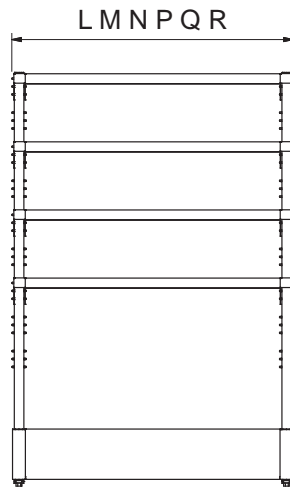
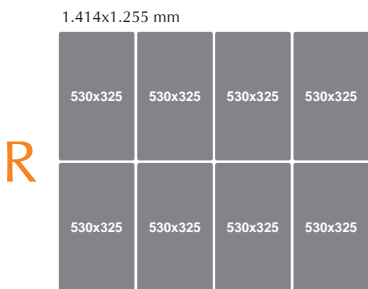
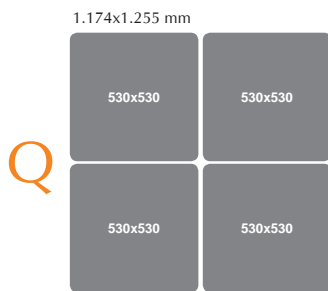
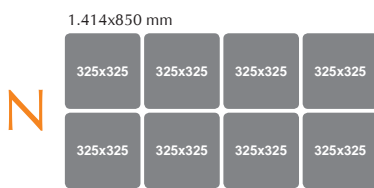
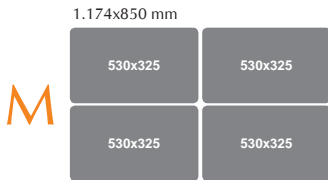
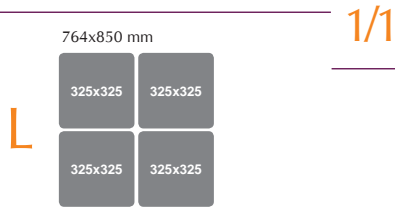

Composiciones básicas
 Basic structures
 Structures basiques

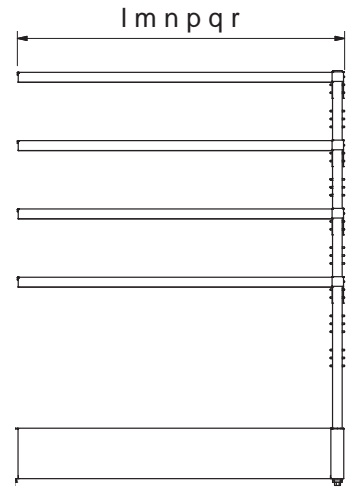

Prolongación de composiciones básicas
 Extended basic structures
 Structures basiques prolongées

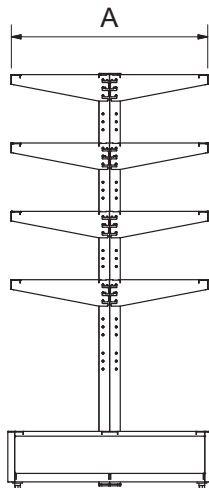

		Número de estantes Number of shelves Numéro d'étagères		
		3	4	5
←→	A	€	€	€
L	764 850	1.236,40	1.478,40	1.720,40
l	711 850	875,60	1.069,20	1.262,80
M	1.174 850	1.403,60	1.694,00	1.984,40
m	1.121 850	1.042,80	1.284,80	1.526,80
N	1.414 850	1.645,60	2.006,40	2.367,20
n	1.361 850	1.284,80	1.597,20	1.909,60
P	764 1.255	1.498,20	1.779,80	2.061,40
p	711 1.255	1.032,90	1.255,10	1.477,30
Q	1.174 1.255	1.718,20	2.065,80	2.413,40
q	1.121 1.255	1.252,90	1.541,10	1.829,30
R	1.414 1.255	1.960,20	2.378,20	2.796,20
r	1.361 1.255	1.494,90	1.853,50	2.212,10

Pies murales imagine
 Wall-side legs imagine
 Pieds muraux imagine

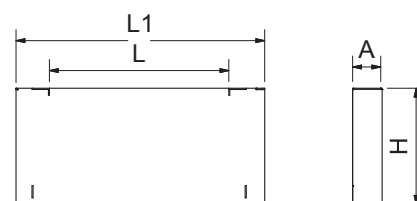

L	A	H	L1	Kg	Barcode	€
325	53	210	450	3,50	013806	80,30
530	53	210	655	5,25	013808	102,30

Pies centrales imagine
 Centre legs imagine
 Pieds centraux imagine

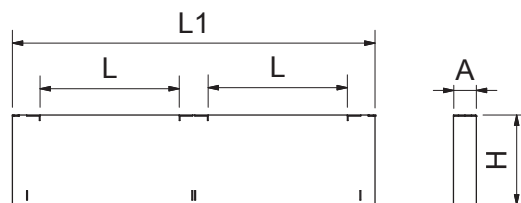
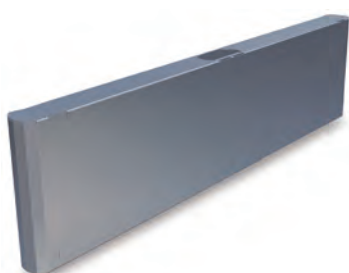

L	A	H	L1	Kg	Barcode	€
325	53	210	850	6,2	013802	121,00
530	53	210	1.260	9,2	013804	203,50

Largueros inferiores imagine
 Lower crossbars imagine
 Montants inférieurs imagine

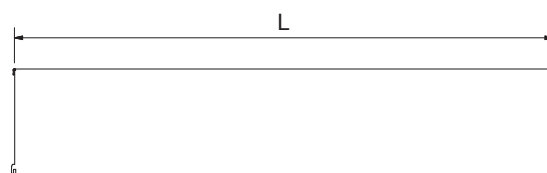

L	Kg	Barcode	€
665	2,7	014252	40,70
1.075	4,0	014254	53,90
1.315	5,4	014256	68,20

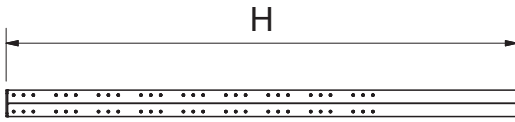

H	Kg	Barcode	€
1.700	6	013602	143,00

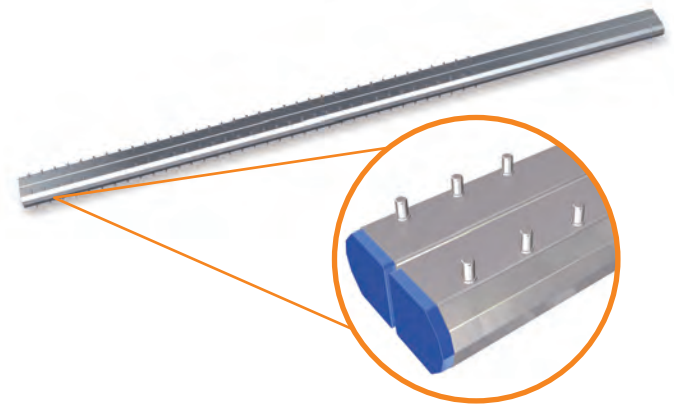

Montante imagine suspendida

Support for Imagine hanging wall shelf
Support pour Imagine murale suspendue

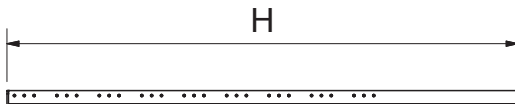

H	Kg	Barcode	€
860	1,5	013606	57,20
1.700	3,0	013604	89,10

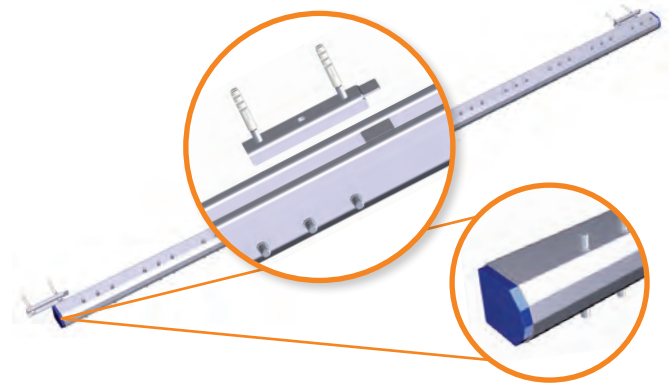

Cartelas imagine

Brackets imagine
Consoles imagine

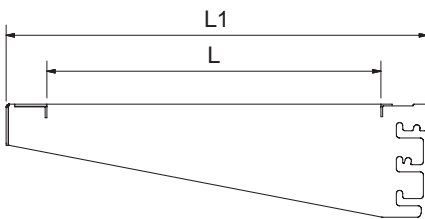

L	L1	Kg	Barcode	€
325	410	1,8	014002	24,20
530	615	2,5	014004	29,70



Largueros superiores imagine

Upper crossbars imagine
Montants supérieurs imagine

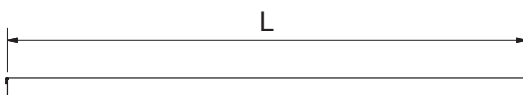

L	Kg	Barcode	€
665	1,3	014202	20,90
1.075	1,9	282806	28,60
1.315	2,4	014204	35,20

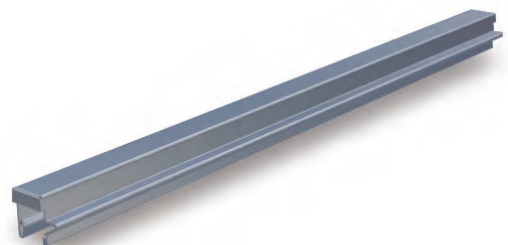

Estantes inox imagine

Stainless steel shelves imagine
Étagères en acier inoxydable imagine

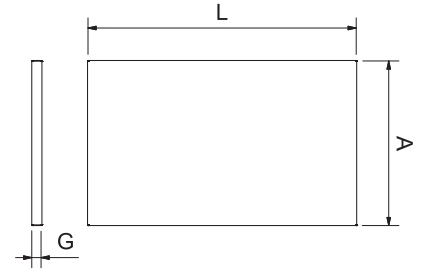
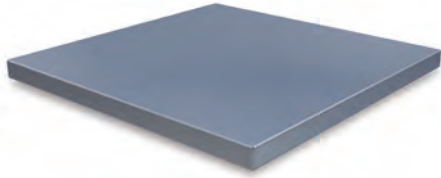

L	A	G	Kg	Barcode	€
325	325	20	1,0	013402	15,40
530	325	20	1,5	013404	19,80
530	530	20	2,0	013406	28,60

Estantes fibra imagine

Polyethylene shelves imagine
Étagères en polyéthylène imagine

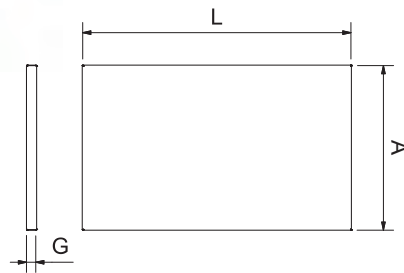
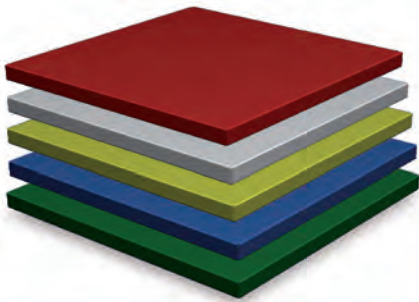

Color	L	A	G	Kg	Barcode	€
Red	325	325	20	2,12	434602	17,00
	530	325	20	3,45	434604	27,00
	530	530	20	5,62	434606	45,00
Yellow	325	325	20	2,12	434610	17,00
	530	325	20	3,45	434612	27,00
	530	530	20	5,62	434614	45,00
Blue	325	325	20	2,12	434620	18,00
	530	325	20	3,45	434622	31,00
	530	530	20	5,62	434624	47,00
Green	325	325	20	2,12	434630	18,00
	530	325	20	3,45	434632	31,00
	530	530	20	5,62	434634	47,00
Grey	325	325	20	2,12	434640	18,00
	530	325	20	3,45	434642	31,00
	530	530	20	5,62	434644	47,00

Hacer agujero de desbarasado a estantes imagine

Imagine shelf perforation for waste chutes
Perforer étagère imagine pour évacuation de déchets

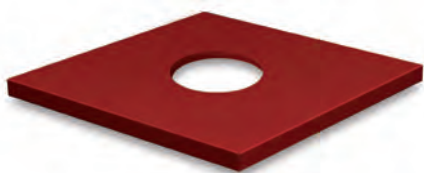
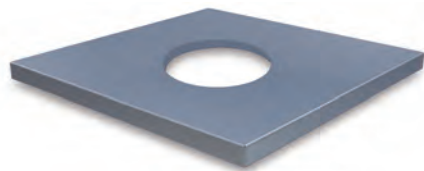

Color	Material	Barcode	€
Grey	Acero inoxidable Stainless steel Acier inoxydable	015002	44,00
Red	Fibra Fibre Fibre	434802	29,00

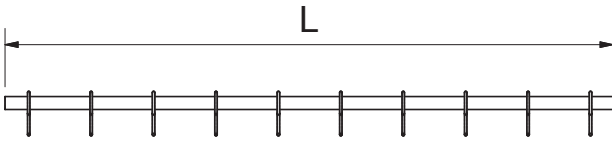

L	Número de ganchos incluidos Number of hooks included Número de crochets inclus	Kg	Barcode	€
650	10	0,30	014602	33,00
1.060	10	0,50	014604	35,00
1.300	20	0,65	014606	36,00

H	E	D	Barcode	€
60	16	3	022502	47

Boxes modulares
 Modular boxes
 Boxes modulaires

Con este sistema de boxes modulares ya puede configurar a su medida las mesas, fregaderos, estanterías, tajos, etc.

Basados en las dimensiones internacionales GASTRONORM están fabricados totalmente en acero inoxidable. Su diseño moderno y funcional permite adaptar guías, cajones, cubetas, puertas etc.

With this system of modular boxes now you can adapt to your needs tables, sink units, shelving units, chopping blocks, etc.

Based in the international dimensions GASTRONORM, it is made totally from stainless steel. Its innovative and functional design allows the fitting of elements such as guides, drawers, pans, doors, etc.

Avec le système de boxes modulaires maintenant vous pouvez adapter à vos besoins tables, éviers, étagères, billots, etc.

Ce système, basé dans les mesures internationales GASTRONORM, est fabriqué totalement en acier inoxydable. Sa conception moderne et fonctionnelle permet d'adapter guides, tiroirs, bacs, portes, etc.

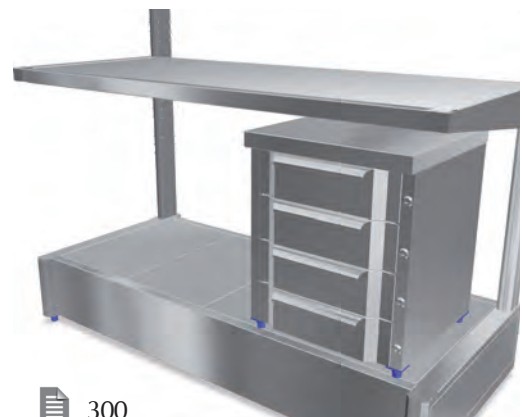

300

Cajón acoplado a estante 2/1 imagine
 Drawer assembled to shelf 2/1 imagine
 Tiroir assemblé à étagère 2/1 imagine



Barcode	€
	242,00
	271,00

Porta-precios imagine

Price-holder imagine
Porte prix imagine



Se acoplan con facilidad a los largueros superiores.

Easy to assemble to the upper crossbars.

Facilité d'assemblage aux montants supérieurs.

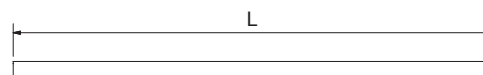

L	Gr	Barcode	€
650	65	415250	4,80
1.060	105	415252	7,50
1.300	130	415254	8,50

Útil de montaje imagine

Assembly tool imagine
Outil de montage imagine



Facilita considerablemente el montaje.

It makes the assembly greatly easier.

Il facilite l'assemblage.

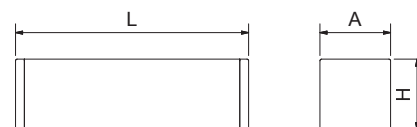

L	A	H	Gr	Barcode	€
125	40	40	180	014402	3,00

Peto transparente imagine

Transparent front panel for imagine
Panneau frontal transparent pour imagine

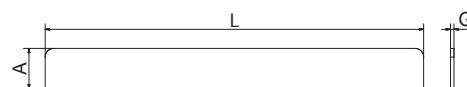

L	A	G	Gr	Barcode	€
655	70	6	175	014802	40,00
1.065	70	6	250	014804	50,00
1.305	70	6	375	014806	60,00

Pinzas porta-precios imagine

Price-holder clamp for imagine
Pince à dessin porte-prix pour imagine



Height	Gr	Barcode	€
100	40	413402	3,00
105	40	413404	4,00
150	48	413406	4,75
190	42	413408	4,50
145	38	413410	2,70



412
Cubetas Gastronorm.
 Gastronorm trays.
 Bacs gastronorm.



434602
 434802



46,00



32

Estante en fibra de polietileno con agujero.
 Perforated polyethylene shelves.
 Étagères perforées en polyéthylène.



486004 247,00 370



Contenedor inoxidable con tapa.
 Stainless steel dustbin.
 Poubelle inox.



91

Cuchillería profesional.
 Professional cutlery.
 Coutellerie professionnelle.

Incluido / Included / Inclus

Opcional / Optional / Optionnel



L	A	H	Kg	Barcode	€
764	1.050	1.700	61	CE-A	1.115,40
1.174	1.050	1.700	71	CE-B	1.265,00
1.414	1.050	1.700	82	CE-C	1.456,40

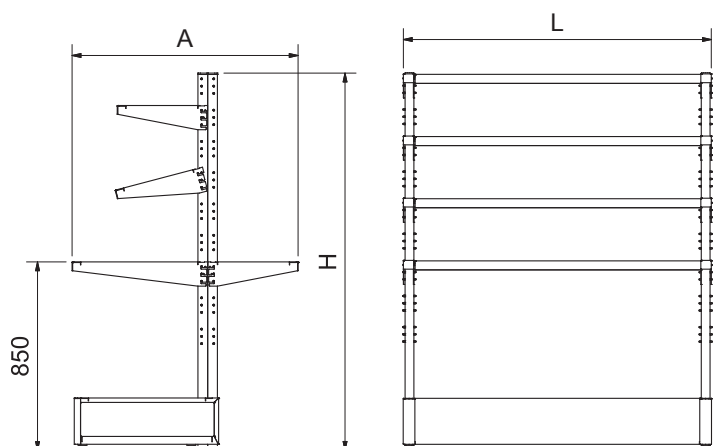

Mesa mural con estantes sobremesa serie imagine

Wall-side table with superior shelves series imagine
Table murale avec étagères sur table modèle imagine



014602 33

Kit para colgar utensilios.
Tool-holder kit.
Kit pour suspendre outils.



448616 115,00 341

Guante de malla de acero inoxidable Expert.
Expert stainless steel mesh glove.
Gant en maille d'acier inoxydable Expert.



454802 67,00 208

Escurridor de platos y vasos de 510 mm.
Plate and glasses 510 mm rack.
Égouttoir pour assiettes et verres 510 mm.



128



Tijeras pescadero.
Fish scissors.
Ciseaux à poisson.



434602 46,00 32

Estante en fibra de polietileno con agujero.
Perforated polyethylene shelves.
Étagères perforées en polyéthylène.



91



Cuchillería profesional.
Professional cutlery.
Coutellerie professionnelle.



412



Cubetas Gastronorm.
Gastronorm trays.
Bacs gastronorm.



486004 247,00 370

Contenedor inoxidable con tapa.
Stainless steel dustbin.
Poubelle inoxydable.



085452 271,00 33

Cajón acoplado.
Coupled drawer.
Tiroir accouplé.

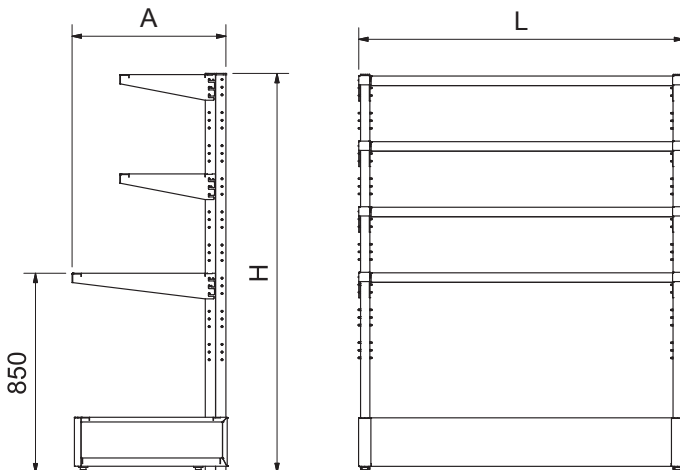

Incluido / Included / Inclus
 Opcional / Optional / Optionnel

L	A	H	Kg	Barcode	€
764	655	1.700	55	MES-A	994,40
1.174	655	1.700	64	MES-B	1.119,80
1.414	655	1.700	73	MES-C	1.276,00

454802 67,00 208

Escurridor de platos y vasos de 510 mm.
 Plate and glasses 510 mm rack.
 Égouttoir pour assiettes et verres 510 mm.

081802 25,00 431

Porta notas mural acoplado.
 Wall mounted note holder.
 Porte notes mural.

434442 125,00 89

Mortero de fibra.
 Mortar.
 Mortier.

080202 60,00 382

Dispensador de bobinas para envolver de 350 mm.
 Dispenser rolls of wrapping material.
 Dévidoir de rouleaux pour protéger les aliments.

434440 43,00 88

Rodillo de fibra.
 Rolling pin.
 Rouleau.

91

Cuchillería profesional.
 Professional cutlery.
 Coutellerie professionnelle.

486004 247,00 370

Contenedor inoxidable con tapa.
 Stainless steel dustbin.
 Poubelle inoxydable.

431608 24,00 80

Fibra estándar azul de 500x300x20 mm.
 Blue standard fibre 500x300x20 mm.
 Fibre standard bleue 500x300x20 mm.

041202 125,00 133

Portacuchillos con doble alojamiento de sobremesa.
 Plated knife holder for mounting.
 Porte-couteaux plaqué pour adosser.



Incluido / Included / Inclus
 Opcional / Optional / Optionnel

L	A	H	Kg	Barcode	€
764	1.255	1.700	77	CES-A	1.700,60
1.174	1.255	1.700	95	CES-B	1.951,40
1.414	1.255	1.700	115	CES-C	2.263,80

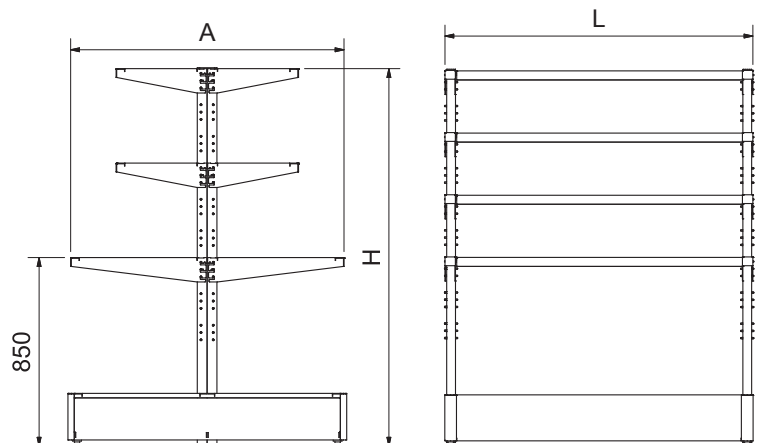

Accesorios para estanterías

Accessories for shelves
Accessoires pour étagères

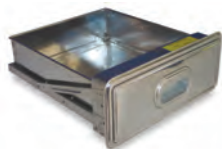

Cajones
Drawers
Tiroirs



462



Boxes modulares
Modular boxes
Boxes modulaires

300



Ruedas
Wheels
Rouelle

466



Taco regulable para soporte de estantería
Adjustable block for shelving support
Taquet réglable pour supports de rayonnage

468



Cubetas Gastronorm lisas
Non-perforated Gastronorm containers
Bacs Gastronorm lisses

412

HERRAJES

Hooks and stainless steel fixtures
Ferrures et crochets



NOVEDADES

News

Nouveautés

Ganchos de varilla tipo "S" y "J" dobles sin puntas Double blunt rod hooks, "S" and "J" type Crochets en forme de tige "S" et "J" doubles sans pointe	47
Gancho de varilla modelo "C" Model "C" rod hook Crochet à tige modèle "C"	48
Gancho jamonero para pletina Ham hook for plate Crochets à jambon pour barre.....	48
Gancho cuelga bolsas Bag holder hook Crochets pour accrocher des sacs	49
Gancho de varilla multifunción Multifunctional rod hook Crochet à barre multifonctionnel	49
Gancho de arrastre Pulling hook Crochet d'entraînement	50
Soporte jamón RT Ham holder RT Support jambon RT	64
Perfil paragolpes ángulo exterior de fibra blanca White polyethylene fender plinth for exterior angle Pare-chocs mural d'angle extérieur en fibre blanche	66
Perfil paragolpes ángulo interior de fibra blanca White polyethylene fender plinth for interior angle Pare-chocs mural d'angle intérieur en fibre blanche	66
Perfil paragolpes recto de fibra blanca Straight white polyethylene fender plinth Pare-chocs mural en fibre blanche	66
Tuerca ciega hexagonal con autoseguro Hexagon self-locking nut with cup Ecrou borgne hexagonal avec auto-sécurité	71

Columnas perforadas para pletina

Perforated columns for plates
Colonnes perforées pour platine



Características:

La principal ventaja del sistema de columnas perforadas para pletina es la facilidad de montaje, pues al pasar la pletina a través de la columna nos permite desplazarla lateralmente (en caso de encontrar algún obstáculo como un desagüe que vaya a la pared, etc.). Con el sistema de separadores estándar se consigue adaptar perfectamente todo el conjunto de columnas al perímetro de la cámara, logrando una excelente estabilidad, además de no tener que quitar las curvas sanitarias que todas las cámaras llevan en paredes y suelos.

Como opción se pueden solicitar pletinas de cruce (tal y como figura en la fotografía), teniendo en cuenta que la distancia entre columnas no debe superar los 1.000 mm. También se fabrican, bajo pedido, columnas para apoyo con diferentes alturas de barras. La pletina para estas columnas tiene que ser de 40x8 mm necesariamente.

Characteristics:

The main advantage of the perforated column system for plate is the ease of installing, since when passing the plate through the column you can move it laterally in the case of any obstacle (such as any drainpipe on the wall, etc.). Furthermore, and with the standard detacher system, you can get a perfect joint of the whole column set within the chamber perimeter, resulting in an excellent stability. Also, there is no need to remove the sanitary curve all chambers have in walls and floor.

In addition, and as an option, you can ask for crossing plates (as can be seen in the drawing), taking into account that distance between columns must not exceed 1.000 mm. They are made as well in several height bars, etc previous order. Plate for these columns must be 40x8 mm compulsory.

Aportando las medidas interiores útiles (Largo-Ancho-Alto) de la cámara, así como la situación de la puerta con sus medidas de ancho y alto, informaremos del precio, plazo de entrega y modo de montaje.

Providing us with the interior measurements (length-width-height), the location of the door and its measurements of width and height, we shall be able to give you its price, the delivery delay and the most convenient way of assemblage.

Si vous nous donnez les mesures intérieures nécessaires (hauteur, largeur, longueur), la position de la porte, ses mesures en largeur et en hauteur, nous vous informerons sur le prix, le délai de livraison et le mode de montage.

Caractéristiques:

La principale avantage du système de colonnes perforées pour platines c'est la facilité du montage, car quand on passe la platine à travers le colonne, il est possible le déplacement latéral dans le cas de trouver quelque obstacle (comme les décharges des eaux dans le mur, etc.). Autre cela, et avec le système standard des séparateurs, on achève une parfaite adaptation pour l'assemblage dans tout le périmètre du chambre. En plus, on n'a pas besoin de quitter les courbures sanitaires que tous les chambres doivent avoir dans murs et sol.

En autre, et optionnellement, vous pouvez commander platines d'intersection (tel que la photographie) en tenant en compte la distance entre colonnes, qu'elle ne doit pas excéder 1.000 mm. Les colonnes, elles sont fabriquées pour support commande préalable, avec différent hauteur des barres, etc. Les platines pour ces colonnes doivent être 40x8 mm obligatoirement.

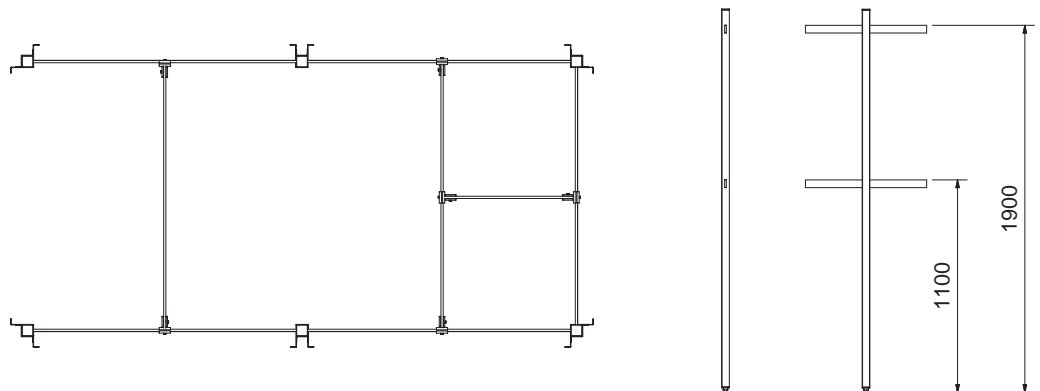

Necesitan 3 separadores por columna para su instalación.
3 separators are required for their installing.
Il sont nécessaires 3 séparateurs pour son installation.

Tornillos opcionales.
Optional screws and bolts.
Vis optionnelles.



Central
Center
Central



Esquina
Corner
Coin



Terminal
Terminal
Terminal

Sección Section Section	Kg	Barcode	€	Barcode	€	Barcode	€
40x40	2,44	020202	61,00	020204	61,00	020206	61,00

Separadores centrales

Central separators
Séparateurs central

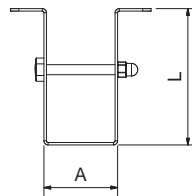
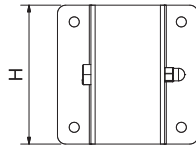

L	A	H	Gr	Barcode	€
80	40	83	300	020402	17,00
140	40	83	600	020406	20,00

Separadores de esquina

Corner separators
Séparateurs de coin

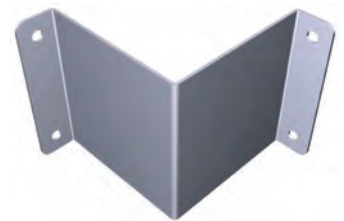
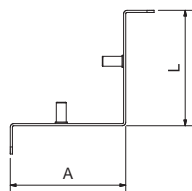

L	A	H	Gr	Barcode	€
80	80	83	300	020404	17,00
140	140	83	600	020408	20,00

Detalles

Details
Détails

Detalle de columna terminal.
Details of terminal column.
Détail colonne terminal.

Detalle de columna central.
Details of the central column.
Détail colonne centrale.

Detalle de columna en esquina.
Details of the corner column.
Détail colonne sur coin.

Detalle de pletinas transversales.
Details of the transversal plates.
Détail barres transversales.

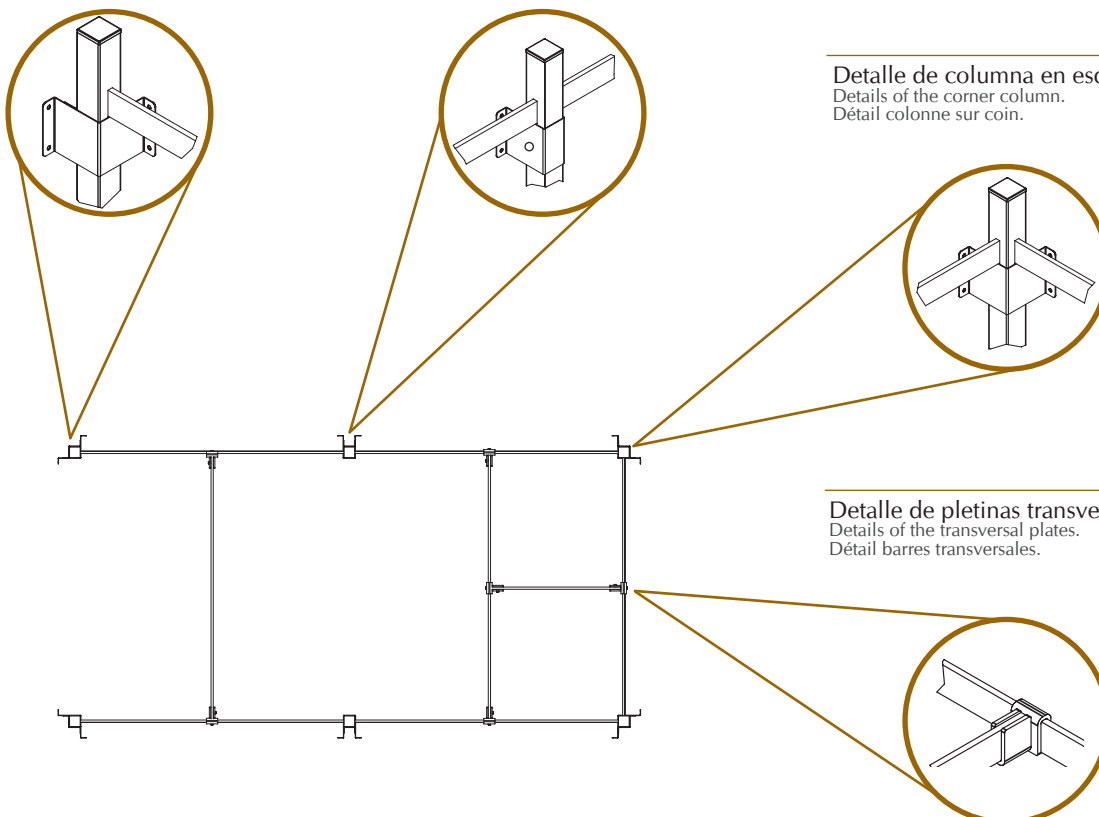

Columnas para tubo

Pipe uprights
Colonnes pour tubes



Aportando las medidas interiores útiles de la cámara (Largo-Ancho-Alto), así como la situación de la puerta con sus medidas de ancho y alto, informaremos de su precio, plazo de entrega y modo de montaje.

Providing us with the interior measurements (Length-Width-Height), the location of the door and its measurements of width and height, we shall be able to give you its price, the delivery delay and the most convenient way of assemblage.

Si vous nous donnez les mesures intérieures nécessaires (hauteur, largeur, longueur), la position de la porte, ses mesures en largeur et en hauteur, nous vous informerons sur le prix, le délai de livraison et le mode de montage.

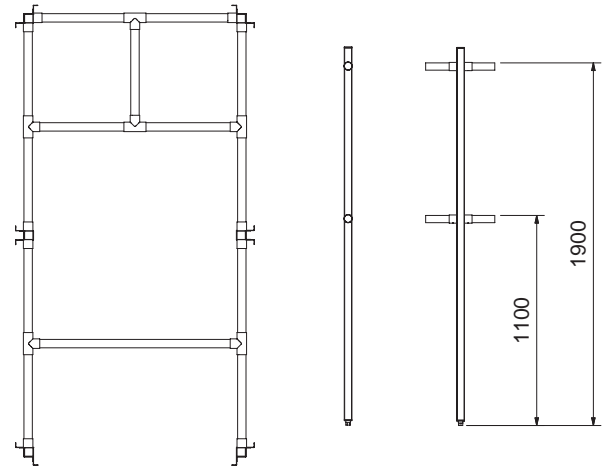

Necesitan 3 separadores por columna para su instalación.
3 separators are required for their installing.
Il sont nécessaires 3 séparateurs pour son installation.

Tornillos opcionales.
Optional screws and bolts.
Vis optionnelles.



Central
Central
Central



Esquina
Corner
Coin



Terminal derecha
Right terminal
Terminal droite



Terminal izquierda
Left terminal
Terminal gauche

Sección Section Section	Kg	Barcode	€	Barcode	€	Barcode	€	Barcode	€
40x40	2,44	020802	173,00	020804	173,00	020806	141,00	020808	141,00

Detalle de columna terminal.
Details of terminal column.
Détail colonne terminal.

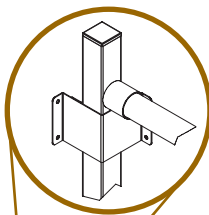

Detalle de columna central.
Details of the central column.
Détail colonne centrale.

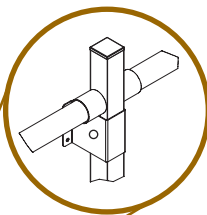

Detalle de columna en esquina.
Details of the corner column.
Détail colonne sur coin.

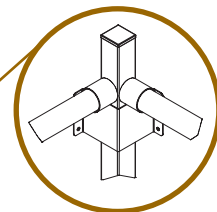

Detalle de tubos transversales.
Details of the transversal pipes.
Détail tubes transversales.

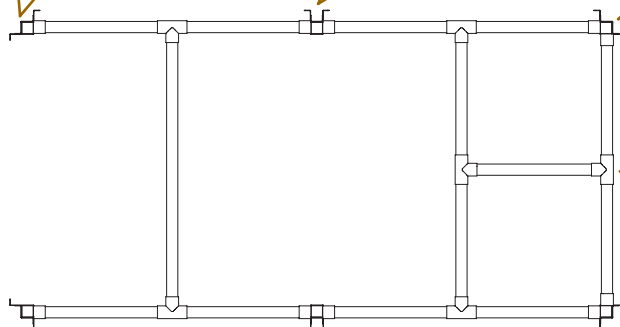
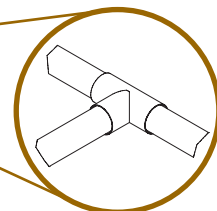

Pletinas

Plates
Platines

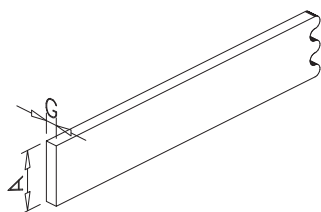

					Precio m m price Prix m
A	G	Gr	Barcode	€	
20	5	800	407808	14,50	
30	5	1.200	407811	20,00	
40	5	1.600	407816	25,00	
40	6	1.920	407820	26,00	
40	8	2.560	407828	30,00	
40	10	3.200	407838	40,00	
50	8	3.200	407832	40,00	

Concepto Concept Concept		Barcode	€
Corte a medida Custom cut Coupe sur mesure	021004	2,80	
Taladro Drill hole Tariere	021002	4,50	



Peso por metro.
Weight per meter.
Poids par mètre.

Tubos

Pipes
Tubes

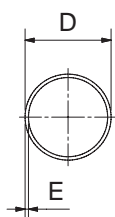

					Precio m m price Prix m
D	E	Gr	Barcode	€	
10	1,0	227	406810	10,50	
16	1,0	377	406824	11,50	
20	1,5	695	407013	12,50	
25	1,0	600	406832	15,00	N
25	1,5	885	407020	16,00	
30	1,5	1.070	407028	16,50	
30	2,0	1.400	407206	19,50	N
35	1,5	1.195	407036	20,50	
38	1,5	1.370	407040	22,00	
43	1,5	1.475	407048	24,00	
76,10	2,0	3.730	407060	50,00	N

Concepto Concept Concept		Barcode	€
Corte a medida Custom cut Coupe sur mesure	021004	2,80	
Tapar extremos inox Inox end cover Boucher extremes inox	021202	20,00	



Peso por metro.
Weight per meter.
Poids par mètre.



Existen tapones de plástico para tapar los extremos del tubo.
There are plastic taps to cover the ends of the tube.
Il y a des bouchers en plastic pour couvrir les bouts du tube.

Ganchos forjados modelo normal

Standard forged hooks
Crochets forgé modèle normal

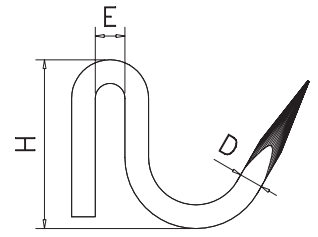

* Presentación en bolsa colgante.
(Ver cantidad por bolsa en el apartado
♥ de la tabla de precios).

* Presented in hanging bags (see quantity
per bag in the ♥ section within the prices
chart).

* Fourni dans sacs suspendus (voir quantité
par sac dans la partie ♥ du tableau de prix).



Precio y peso por unidad.
Unit price and weight.
Prix et poids unitaire.

Uso Use Usage	D	H	E	♥	Gr	Barcode	€
Cordero Lamb Agneau	8	55	8	10*	75	021402	4,25
½ Ternera ½ Calf ½ Veau	10	70	8	1	140	021404	7,80
Ternera Calf Veau	12	111	8	1	280	021406	13,50
Vaca Cow Boeuf	16	135	8	1	505	021408	26,00

Ganchos forjados modelo pestaña

Forged hook model with fringe
Crochets forgés modèle à patte d'ancrage

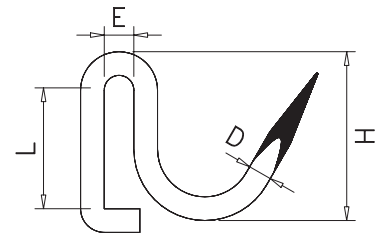

* Presentación en bolsa colgante.
(Ver cantidad por bolsa en el apartado
♥ de la tabla de precios).

* Presented in hanging bags (see quantity
per bag in the ♥ section within the prices
chart).

* Fourni dans sacs suspendus (voir quantité
par sac dans la partie ♥ du tableau de prix).



Precio y peso por unidad.
Unit price and weight.
Prix et poids unitaire.

Uso Use Usage	D	H	E	L	♥	Gr	Barcode	€
Cordero Lamb Agneau	8	55	8	42	10*	80	021602	8,75
½ Ternera ½ Calf ½ Veau	10	70	8	42	1	145	021604	32,00
Ternera Calf Veau	12	105	8	42	1	290	021606	42,00
Vaca Cow Boeuf	16	135	8	42	1	525	021608	53,00

Gancho de varilla modelo " J " con pestaña

Model " J " rod hook with fringe
Crochet à tige modèle " J " avec patte d'ancrage



* Presentación en bolsa colgante.
(Ver cantidad por bolsa en el apartado
♥ de la tabla de precios).

* Presented in hanging bags (see quantity
per bag in the ♥ section within the prices
chart).

* Fourni dans sacs suspendus (voir quantité
par sac dans la partie ♥ du tableau de prix).



Precio y peso por unidad.
Unit price and weight.
Prix et poids unitaire.

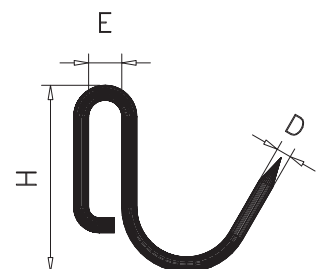

H	E	D	♥	Gr	Barcode	€
55	8	5	10*	25	022266	2,00

Gancho de cordero en varilla

Lamb rod hook
Crochet à tige modèle agneau

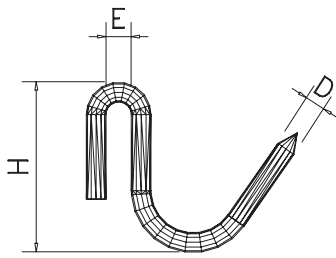

* Presentación en bolsa colgante.
(Ver cantidad por bolsa en el apartado
de la tabla de precios).

* Presented in hanging bags (see quantity
per bag in the section within the prices
chart).

* Fourni dans sacs suspendus (voir quantité
par sac dans la partie du tableau de prix).



Precio y peso por unidad.

Unit price and weight.
Prix et poids unitaire.

H	E	D		Gr		€
60	9	7		10*	48	022229 0,87

Ganchos forjados modelo atornillar

Screw-type forged hook
Crochets forgé modèle pour visser

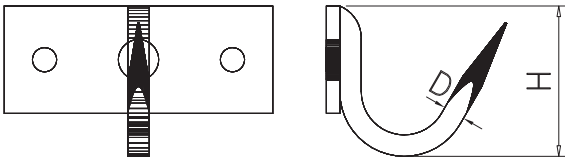

Uso Use Usage	D	H		Gr		€
Cordero Lamb Agneau	8	60	1	120	021802	35,00
½ Ternera ½ Calf ½ Veau	10	70	1	170	021804	40,00
Ternera Calf Veau	12	105	1	345	021806	49,00
Vaca Cow Boeuf	16	135	1	665	021808	61,00

Ganchos forjados modelo recibir

Wall-mounted forged hook
Crochets forgé modèle pour sceller

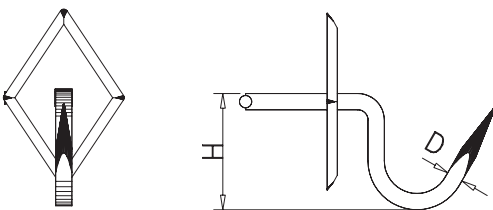

Uso Use Usage	D	H		Gr		€
Cordero Lamb Agneau	8	60	1	115	022002	39,00
½ Ternera ½ Calf ½ Veau	10	70	1	150	022004	42,00
Ternera Calf Veau	12	105	1	325	022006	56,00
Vaca Cow Boeuf	16	135	1	645	022008	71,00

Ganchos de varilla modelo " J "

Rod hooks " J " shaped
Crochets à tige modèle " J "

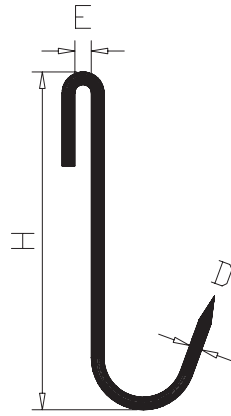

		Grosor de varilla Rod thickness Grosueur de la tige											
		D = 5 mm						D = 6 mm					
H	E	📦	Gr	📊	€	📦	Gr	📊	€	📦	Gr	📊	€
50	9	10*	20	022202	0,74	10*	35	022216	0,99				
100	9	10*	30	022204	0,76	10*	45	022218	1,02				
120	9	10*	35	022206	0,79	10*	50	022220	1,04				
140	9	10*	38	022208	0,81	10*	57	022222	1,05				
160	9	10*	40	022210	0,93	10*	60	022224	1,14				
180	9	10*	45	022212	1,07	10*	65	022226	1,26				
200	9	10*	50	022214	1,28	10*	70	022228	1,29				



* Presentación en bolsa colgante.

(Ver cantidad por bolsa en 📦 de la tabla de precios).

* Presented in hanging bags (see quantity per bag in the 📦 section within the prices chart).

* Fourni dans sacs suspendus (voir quantité par sac dans la partie 📦 du tableau de prix).



Precio y peso por unidad.

Unit price and weight.
Prix et poids unitaire.

		Grosor de varilla Rod thickness Grosueur de la tige											
		D = 7 mm				D = 10 mm				D = 14 mm			
H	E	📦	Gr	📊	€	📦	Gr	📊	€	📦	Gr	📊	€
100	9	10*	70	022230	1,41								
120	9	10*	75	022232	1,47								
140	9	10*	80	022234	1,60	1	180	022242	5,81	1	340	022254	9,33
160	9	10*	85	022236	1,73	1	195	022244	6,01	1	355	022256	10,42
180	9	10*	90	022238	1,86	1	205	022246	6,21	1	365	022258	11,17
200	9	10*	100	022240	2,01	1	220	022248	6,30	1	380	022260	12,16
230	9					1	235	022250	6,58	1	395	022262	13,09
260	9					1	260	022252	6,83	1	420	022264	14,03

Ganchos de varilla modelo " S "

Rod hooks " S " shaped
Crochets à tige modèle " S "

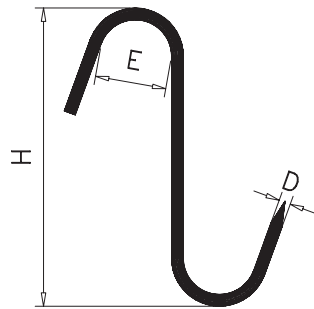

		Grosor de varilla Rod thickness Grosueur de la tige											
		D = 4 mm						D = 5 mm					
H	E	📦	Gr	📊	€	📦	Gr	📊	€	📦	Gr	📊	€
100	30	10	20	022402	0,53	10	30	022404	0,70				
120	39					10	35	022406	0,81				
140	39					10	45	022408	0,88				
160	39					10	50	022410	0,92				
180	39					10	55	022412	0,96				
200	39					10	58	022414	1,02				



* Presentación en bolsa colgante.

(Ver cantidad por bolsa en 📦 de la tabla de precios).

* Presented in hanging bags (see quantity per bag in the 📦 section within the prices chart).

* Fourni dans sacs suspendus (voir quantité par sac dans la partie 📦 du tableau de prix).



Precio y peso por unidad.

Unit price and weight.
Prix et poids unitaire.

		Grosor de varilla Rod thickness Grosueur de la tige											
		D = 6 mm				D = 7 mm				D = 10 mm			
H	E	📦	Gr	📊	€	📦	Gr	📊	€	📦	Gr	📊	€
120	39	10*	55	022416	1,05								
140	39	10*	60	022418	1,07								
160	39	10*	70	022420	1,13	10*	95	022426	1,52				
180	39	10*	75	022422	1,21	10*	105	022428	1,61				
200	39	10*	80	022424	1,41	5*	110	022430	1,77	1	255	022432	5,28
230	39									1	270	022434	5,49
260	39									1	290	022436	5,76

Ganchos de varilla modelo " S " sin puntas

" S " model rod hooks without point
Crochets à tige modèle " S " sans pointe



* Presentación en bolsa colgante.
(Ver cantidad por bolsa en el apartado
de la tabla de precios).

* Presented in hanging bags (see quantity
per bag in the section within the prices
chart).

* Fourni dans sacs suspendus (voir quantité
par sac dans la partie du tableau de prix).



Precio y peso por unidad.

Unit price and weight.
Prix et poids unitaire.

H E D Gr €

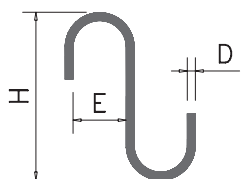

60 16 3 10* 4 022502 0,41

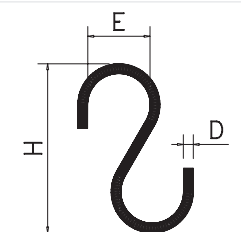

80 30 5 10* 23 022702 0,67



Ganchos de varilla tipo "S" y "J" dobles sin puntas

Double blunt rod hooks, "S" and "J" type
Crochets en forme de tige "S" et "J" doubles sans pointe



H E D Gr €

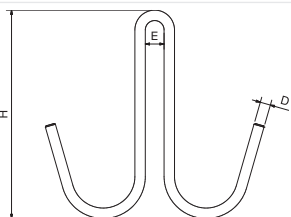

100 9 5 51 022270 1,40

160 9 5 73 022272 1,50

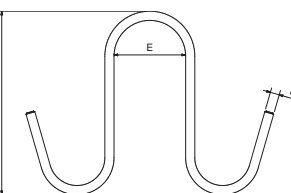

100 39 5 56 022438 1,90

160 39 5 76 022440 2,00

Gancho de varilla modelo "C"

Model "C" rod hook
Crochet à tige modèle "C"



Novedad
Nouvel
nouveau



* Presentación en bolsa colgante.
(Ver cantidad por bolsa en el apartado
de la tabla de precios).
* Presented in hanging bags (see quantity
per bag in the section within the prices
chart).
* Fourni dans sacs suspendus (voir quantité
par sac dans la partie du tableau de prix).



Peso por unidad.
Unit weight.
Poids unitaire.

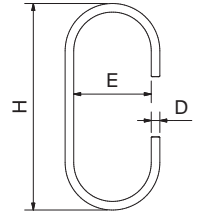

H	E	D		Gr		€
120	45	5		20*	40	022510 20,00

Gancho jamonero para pletina

Ham hook for plate
Crochets à jambon pour barre



Novedad
Nouvel
nouveau



* Presentación en bolsa colgante.
(Ver cantidad por bolsa en el apartado
de la tabla de precios).
* Presented in hanging bags (see quantity
per bag in the section within the prices
chart).
* Fourni dans sacs suspendus (voir quantité
par sac dans la partie du tableau de prix).



Peso por unidad.
Unit weight.
Poids unitaire.

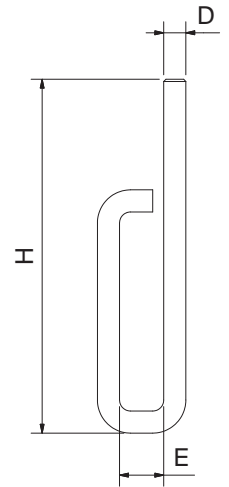

H	E	D		Gr		€
80	10	5		12*	23	275233 8,50

Gancho jamonero atornillar

Screw-type ham hook
Crochet d'arrêt à visser

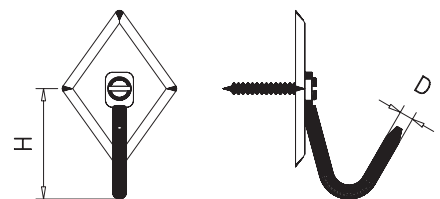

H	D	Gr		€
56	6	30	022602	15,00

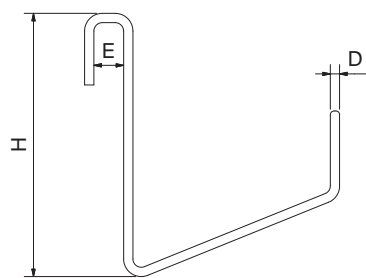

H	E	D	Gr		€
142	16	5	55	211920	0,69

Gancho cuelga bolsas

Bag holder hook
Crochets pour accrocher des sacs

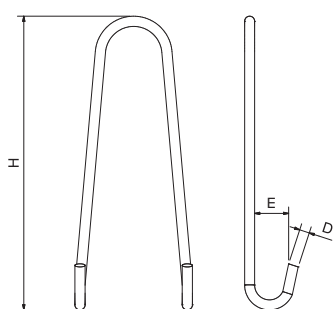

H	E	D	Gr		€
115	13	4	29	022520	0,55

Gancho de varilla multifunción

Multifunctional rod hook
Crochet à barre multifonctionnel

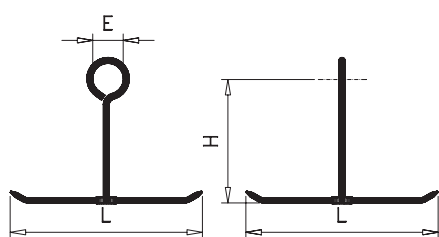

L	E	H	Gr		€
215	40	145	170	023402	26,00

Gancho giratorio salchichero

Revolving sausage hook
Crochet tournant de charcuterie

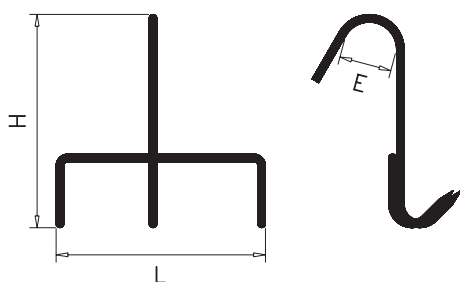

L	E	H	Gr		€
130	39	170	80	023602	23,00

Gancho 3 puntas

3 points hook
Crochet à 3 griffes



Gancho de arrastre

Pulling hook
Crochet d'entraînement



Novedad
nouveau

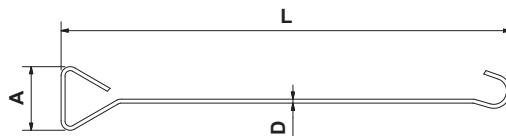

L	A	D	Gr	Barcode	€
760	107	7	301	023702	10,00

Gancho giratorio modelo " J "

Model " J " revolving hook
Crochet tournant modèle " J "

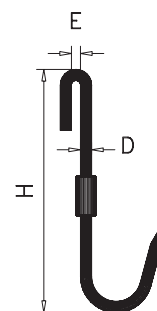

H	E	D	Gr	Barcode	€
260	10	11	380	422202	20,00

Gancho giratorio modelo " S "

Model " S " revolving hook
Crochet tournant modèle " S "

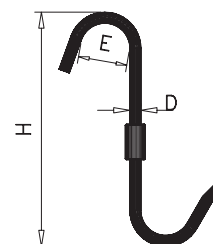

H	E	D	Gr	Barcode	€
240	50	11	380	422402	20,00

Ganchos salchicheros sencillos

Single sausage hooks
Crochets de charcuterie simple

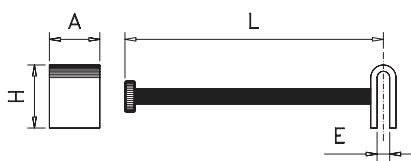

L	E	A	H	Gr	Barcode	€
200	10	40	50	320	022802	33,00
300	10	40	50	415	022804	43,00

Ganchos salchicheros dobles

Double sausage hooks
Crochets de charcuterie double

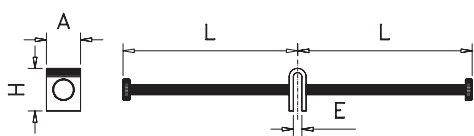

L	E	A	H	Gr	Barcode	€
200	10	40	50	505	023002	65,00
300	10	40	50	685	023004	79,00

Gancho salchichero con gancho de cordero

Sausage hook with lamb hook
Crochet de charcuterie à griffe pour agneau

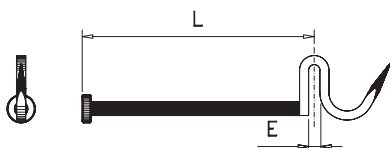

L	E	Gr	Barcode	€
200	8	120	023202	43,00

Ganchos cartela fijo y giratorio

Fixed and revolving hook bracket
Crochet console fixe et giratoire

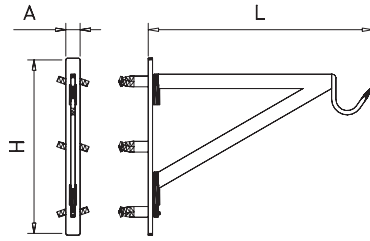

Fijación Screw Fixation	H	A	L	Kg	Barcode	€
Atornillar Screw Visser	495	40	630	5,3	023802	300,00
Recibir Fix to the wall Adosser dans le mur	495	40	630	5,4	023804	300,00

Soporte cartela fijo y giratorio para balanzas

Fixed and revolving hook bracket for scales
Crochet console fixe et giratoire pour balances

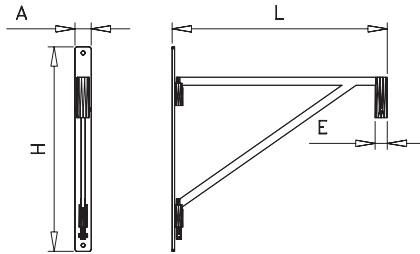

H	A	L	E	Kg	Barcode	€
450	40	535	30	1,55	024002	275,00

Kit para colgar utensilios

Tool-holder kit
Kit pour suspendre outils



Características:

Construido totalmente en acero inoxidable.
Gran resistencia.
Provisto de 10 ganchos (022502).
Incluye tornillos y tacos para fijar a la pared.
Libera superficie de trabajo en la encimera.
También se puede usar como toallero o para colgar las tapas de las cubetas y las ollas.



L	A	H	Gr	Barcode	€
750	50	100	500	020102	40,00

Characteristics:

Totally made in stainless steel.
High solidity.
Provided with 10 hooks (022502).
It saves room on the worktop.
It also can be used as a towel rail or to hold the lids of tanks and pots.
Bolts and rawlplugs to fix onto the wall included.

Caractéristiques:

Construit tout en acier inox.
Grande solidité.
Pourvu avec 10 crochets (022502).
Il libère de l'espace sur le dessus.
Possibilité de l'utiliser comme porte-serviette ou porte-couvercles de bacs et pots.
Vis et ancrages pour fixation au mur inclus.



Gancho opcional.
Optional hook.
Crochet optionnel.



47

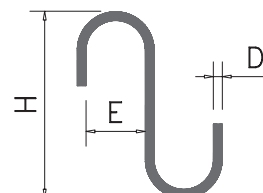

H	E	D	Barcode
---	---	---	---------

60 16 3 022502

Barra mural con ganchos

Wall mounted rack with hooks
Barre dents de loup



Características:

Pletina de 40x8 mm.
Pletina pulida a las cuatro caras.
Ganchos móviles.
Posibilidad de añadir y quitar ganchos.
Dos robustos soportes para la sujeción a pared.

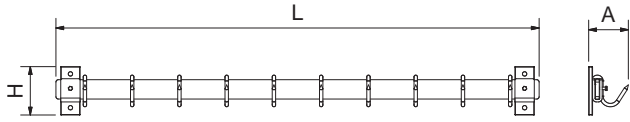

Characteristics:

Bar of 40x8 mm.
Polished on four sides.
The hooks can be positioned.
Possibility of removing or adding hooks.
Wall fixation by 2 solid brackets.

Caractéristiques:

Barre de 40x8 mm.
Barre polie des 4 côtés.
Crochets amovibles.
Possibilité de mettre et enlever des crochets.
Deux supports robustes pour la fixation au mur.

L	A	H	Nº Ganchos Hooks Crochets	Kg	Barcode	€
1.000	90	100	10	3,00	024220	109,00
1.500	90	100	10	4,00	024222	125,00

Tochos de hierro cincado rosca métrica

Zinc-plated thick iron rods and metric threads
Goujons en fer zingué à filetage métrique



L	D	L1	D1	Gr	Barcode	€
150	18	20	M14	205	029802	9,00
200	18	20	M14	300	029804	10,00
250	18	20	M14	400	029806	11,00

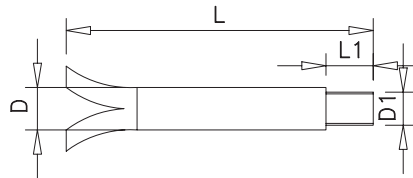

Soporte central

Central support
Support central

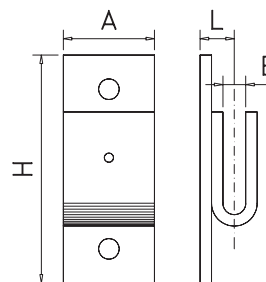

Soporte lateral

Side support
Support latéral

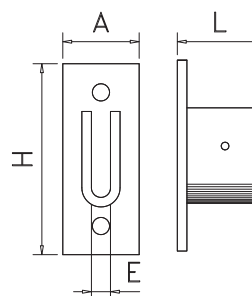

H	A	L	E	Gr	Barcode	€
100	40	18	10	345	024402	24,00

H	A	L	E	Gr	Barcode	Barcode	€
100	40	45	10	345	024602	024604	24,00

Soportes laterales para tubo

Side supports for pipe
Supports latéral pour tube

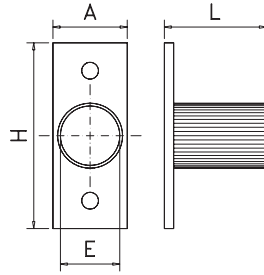

H	A	L	E	Gr	Barcode	€
100	40	45	30	190	026202	24,00
100	40	45	38	200	026204	24,00

Soportes rectos para recibir

Wall-mounted straight supports
Supports droits pour sceller

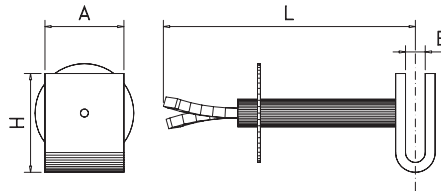

H	A	L	E	Gr	Barcode	€
50	40	130	10	320	024802	65,00
50	40	180	10	350	024804	71,00
50	40	230	10	455	024806	77,00

Soportes rectos en tubo para recibir

Wall-mounted straight pipe supports
Supports droits en tube pour sceller

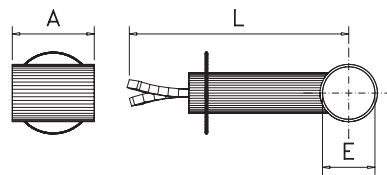

A	L	E	Gr	Barcode	€
60	130	30	218	026402	65,00
		38	233	026404	
60	180	30	248	026406	71,00
		38	263	026408	
60	230	30	313	026410	77,00
		38	328	026412	

Plafones para exposición de embutidos

Sausage display boards
Panels d'exposition pour charcuterie

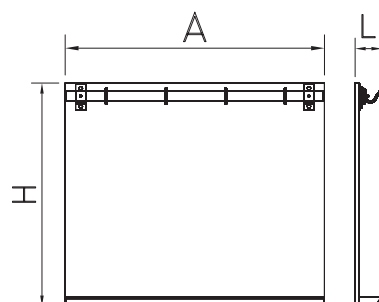

Gancho opcional. 021602
Optional hook.
Crochet optionnel.



44

A	L	H	Nº Ganchos Hooks Crochets	Kg	Barcode	€
800	110	865	3	10	024202	390,00
1.000	110	865	4	11	024204	436,00
1.500	110	865	5	15	024206	560,00

Soportes puente con trasera
 Bridge supports with back
 Supports de pont avec arrière-train

H	A	L	E	Gr	Barcode	€
200	40	140	10	975	025002	97,00
290	40	240	10	1.385	025004	118,00

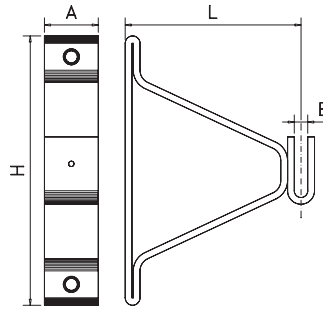

Soportes puente sin trasera
 Bridge supports without back
 Supports de pont sans arrière-train

H	A	L	E	Gr	Barcode	€
200	40	135	10	645	025202	66,00
290	40	235	10	935	025204	91,00

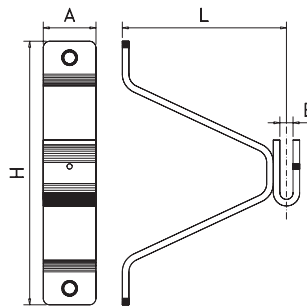

Soportes rectos
 Straight supports
 Supports droit

H	A	L	E	Gr	Barcode	€
100	40	50	10	325	025402	44,00
100	40	100	10	400	025404	46,00
100	40	150	10	475	025406	50,00
100	40	200	10	550	025408	54,00

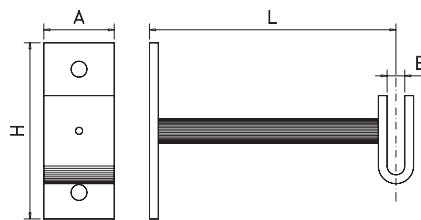

Soportes puente con trasera para tubo
 Pipe bridge supports with back
 Supports de pont avec arrière-train pour tube

H	A	L	E	Gr	Barcode	€
200	40	145	30	840	026602	97,00
		149	38	855	026604	
290	40	245	30	1.285	026606	118,00
		249	38	1.300	026608	

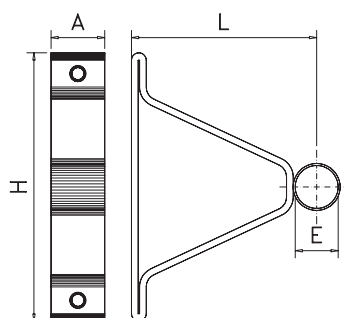

Soportes puente sin trasera para tubo

Pipe bridge supports without back
Supports de pont sans arrière-train pour tube

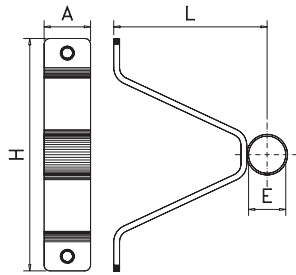

H	A	L	E	Gr	Barcode	€
200	40	140	30	540	026802	66,00
		144	38	550	026804	
290	40	240	30	845	026806	91,00
		244	38	855	026808	

Soportes rectos para tubo

Pipe straight supports
Supports droits pour tube

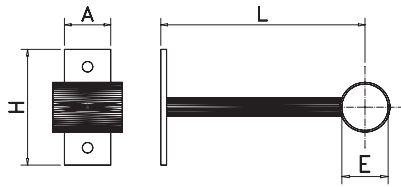

H	A	L	E	Gr	Barcode	€
100	40	50	30	220	027002	44,00
			38	280	027004	
100	40	100	30	295	027006	46,00
			38	310	027008	
100	40	150	30	370	027010	50,00
			38	385	027012	
100	40	200	30	445	027014	54,00
			38	460	027016	

Cartelas abatibles para estantes murales

Hinged brackets for wall shelves with brackets
Consoles battante pour d'étagères murale



***HASTA 100 Kg
por cartela**

Maximum load per
bracket 100 Kgs.
Charge maximale par
console de 100 Kgs.

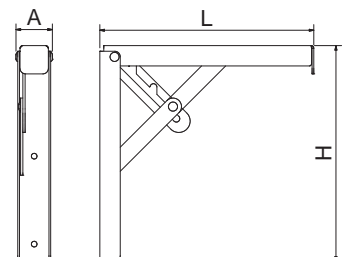

Barcode	€
013204	20,00
013202	5,00

L	A	H	Kg	Barcode	€
200	30	185	0,33	421254	47,00

Tirantes de techo

Ceiling rods
Tringles de plafond



Cada 50 mm. de más o fracción aumentará 2 Euros.
Each additional 50 mm. or fraction will cost 2 Euros.
Chaque 50 mm. supplémentaires ou fraction aura un accroissement de prix de 2 Euros.

H	A	L	E	Gr	Barcode	€
100	40	100	10	360	025602	61,00
150	40	100	10	380	025604	63,00
200	40	100	10	400	025606	66,00
250	40	100	10	420	025608	68,00
300	40	100	10	440	025610	70,00
350	40	100	10	460	025612	74,00
400	40	100	10	480	025614	76,00
450	40	100	10	500	025616	78,00
500	40	100	10	520	025618	81,00
550	40	100	10	540	025620	83,00
600	40	100	10	560	025622	85,00
650	40	100	10	580	025624	88,00
700	40	100	10	600	025626	91,00
750	40	100	10	620	025628	93,00
800	40	100	10	640	025630	96,00
850	40	100	10	660	025632	99,00
900	40	100	10	680	025634	101,00
950	40	100	10	690	025636	103,00
1.000	40	100	10	695	025638	106,00

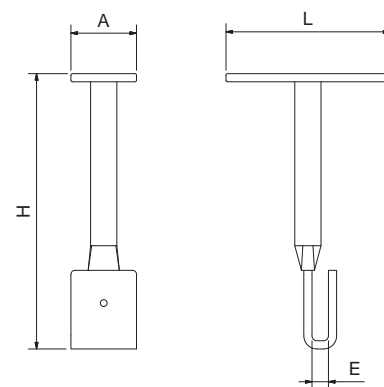

Tirantes de techo con varilla roscada

Ceiling rods with thread
Tringles de plafond avec filetage



Cada 50 mm. de más o fracción aumentará 2 Euros.
Each additional 50 mm. or fraction will cost 2 Euros.
Chaque 50 mm. supplémentaires ou fraction aura un accroissement de prix de 2 Euros.

H	h	E	D	Gr	Barcode	€
100	150	10	M14	410	025802	61,00
150	150	10	M14	430	025804	63,00
200	150	10	M14	450	025806	66,00
250	150	10	M14	470	025808	68,00
300	150	10	M14	490	025810	70,00
350	150	10	M14	510	025812	74,00
400	150	10	M14	530	025814	76,00
450	150	10	M14	550	025816	78,00
500	150	10	M14	570	025818	81,00
550	150	10	M14	590	025820	83,00
600	150	10	M14	600	025822	85,00
650	150	10	M14	650	025824	88,00
700	150	10	M14	700	025826	91,00
750	150	10	M14	750	025828	93,00
800	150	10	M14	800	025830	96,00
850	150	10	M14	850	025832	99,00
900	150	10	M14	900	025834	101,00
950	150	10	M14	950	025836	103,00
1.000	150	10	M14	1.000	025838	106,00

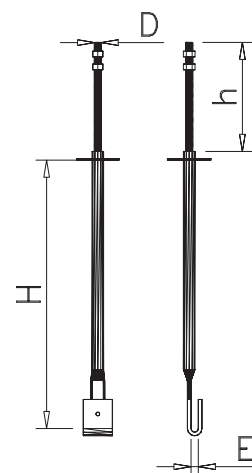
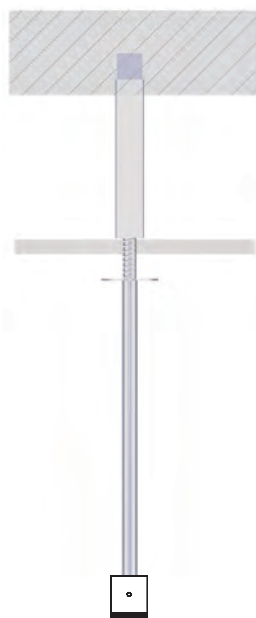

Tirantes de techo para tubo

Ceiling rods for pipe
Tringles de plafond pour tube

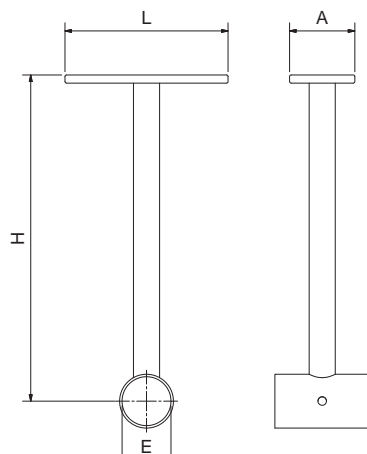
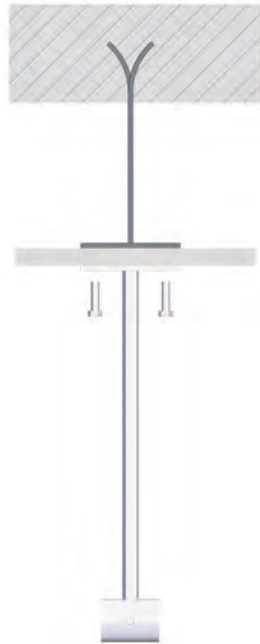

Cada 50 mm. de más o fracción
aumentará 2 Euros.
Each additional 50 mm. or fraction will
cost 2 Euros.
Chaque 50 mm. supplémentaires ou fraction
aura un accroissement de prix de 2 Euros.

H	A	L	E	Gr	Barcode	€
100	40	100	30	300	027202	61,00
			38	320	027204	
150	40	100	30	330	027206	63,00
			38	350	027208	
200	40	100	30	360	027210	66,00
			38	380	027212	
250	40	100	30	390	027214	68,00
			38	410	027216	
300	40	100	30	420	027218	70,00
			38	440	027220	
350	40	100	30	450	027222	74,00
			38	470	027224	
400	40	100	30	480	027226	76,00
			38	500	027228	
450	40	100	30	510	027230	78,00
			38	530	027232	
500	40	100	30	540	027234	81,00
			38	560	027236	
550	40	100	30	570	027238	83,00
			38	590	027240	
600	40	100	30	600	027242	85,00
			38	620	027244	
650	40	100	30	630	027246	88,00
			38	650	027248	
700	40	100	30	660	027250	91,00
			38	680	027252	
750	40	100	30	690	027254	93,00
			38	710	027256	
800	40	100	30	720	027258	96,00
			38	740	027260	
850	40	100	30	750	027262	99,00
			38	770	027264	
900	40	100	30	780	027266	101,00
			38	800	027268	
950	40	100	30	810	027270	103,00
			38	830	027272	
1.000	40	100	30	840	027274	106,00
			38	860	027276	

Tirantes de techo para tubo con varilla roscada

Ceiling rods with thread for pipe
Tringles de plafond avec filetage pour tube

H	h	D	E	Gr	Barcode	€
100	150	M14	30	350	027402	61,00
			38	370	027404	
150	150	M14	30	380	027406	63,00
			38	400	027408	
200	150	M14	30	410	027410	66,00
			38	430	027412	
250	150	M14	30	440	027414	68,00
			38	460	027416	
300	150	M14	30	470	027418	70,00
			38	490	027420	
350	150	M14	30	500	027422	74,00
			38	520	027424	
400	150	M14	30	530	027426	76,00
			38	550	027428	
450	150	M14	30	560	027430	78,00
			38	580	027432	
500	150	M14	30	590	027434	81,00
			38	610	027436	
550	150	M14	30	620	027438	83,00
			38	640	027440	
600	150	M14	30	650	027442	85,00
			38	670	027444	
650	150	M14	30	680	027446	88,00
			38	700	027448	
700	150	M14	30	710	027450	91,00
			38	730	027452	
750	150	M14	30	740	027454	93,00
			38	760	027456	
800	150	M14	30	770	027458	96,00
			38	790	027460	
850	150	M14	30	800	027462	99,00
			38	820	027464	
900	150	M14	30	830	027466	101,00
			38	850	027468	
950	150	M14	30	860	027470	103,00
			38	880	027472	
1.000	150	M14	30	890	027474	106,00
			38	910	027476	

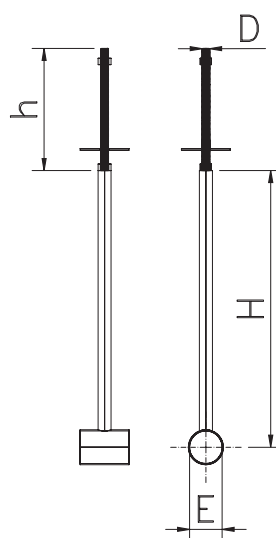
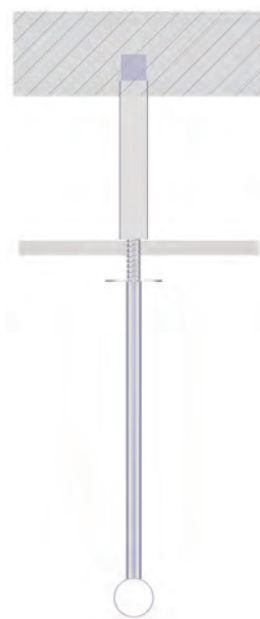

Cada 50 mm. de más o fracción aumentará 2 Euros.

Each additional 50 mm. or fraction will cost 2 Euros.

Chaque 50 mm. supplémentaires ou fraction aura un augmentation de prix de 2 Euros.

Sujeciones de hierro para tirante

Iron fasteners for rod
Fixations de fer pour tringle

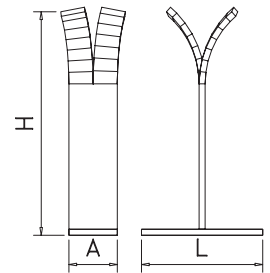

H	A	L	Gr	Barcode	€
100	40	100	240	028402	22,00
200	40	100	360	028404	23,00
300	40	100	480	028406	24,00
400	40	100	600	028408	25,00
500	40	100	720	028410	26,00
600	40	100	840	028412	27,00
700	40	100	960	028414	28,00
800	40	100	1.080	028416	29,00
900	40	100	1.200	028418	30,00
1.000	40	100	1.320	028420	31,00

Garras galvanizadas para tirantes

Galvanized splayed rod clamp
Griffes galvanisées pour tringle

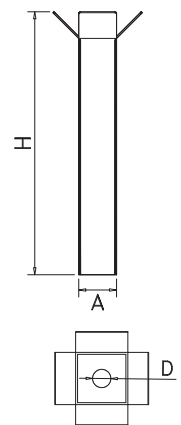
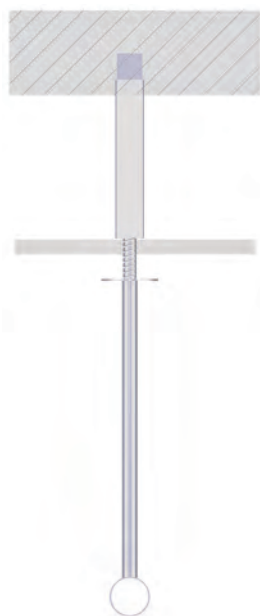

H	A	D	Gr	Barcode	€
100	40	M14	170	028602	22,00
200	40	M14	340	028604	23,00
300	40	M14	510	028606	24,00
400	40	M14	680	028608	25,00
500	40	M14	850	028610	26,00
600	40	M14	1.020	028612	27,00
700	40	M14	1.190	028614	28,00
800	40	M14	1.360	028616	29,00
900	40	M14	1.530	028618	30,00
1.000	40	M14	1.700	028620	31,00

Tirante para balanzas regulable

Adjustable rod for hanging scales
Tringle réglable pour balances suspendues

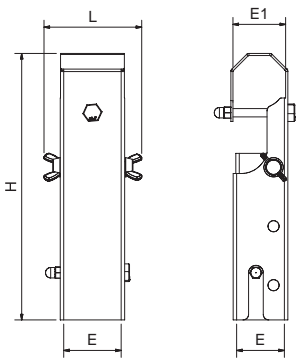

Características:

Diseñado para adaptar la altura de la balanza a cada usuario. La regulación se realiza de una manera fácil, rápida y segura, sin tener que descolgar o desenchufar la balanza. Regulación 86 mm. Para tubo de ø38 mm. arriba. Casquillo de ø40 mm. en balanza.

Characteristics:

Designed to adjust the hanging scale at the desired height. The adjustment can be done in a quick, easy and safe way. You do not need to take down or unplug the scale. Adjustment: 86 mm. For upper tube of ø38 mm. Scale ferrule of ø40 mm.

Caractéristiques:

Conçu pour régler la balance suspendue à la hauteur convenable. L'ajustement peut être fait de manière simple, rapide et en toute sécurité. Vous n'avez pas besoin de décrocher ou de débrancher la balance. Ajustement: 86 mm. Pour tube supérieur de ø38 mm. Virole d'échelle de ø40 mm.

H	L	E	E1	Gr	Barcode	€
192-234-277	70	ø40	ø38	500	028250	43,00

H	E	E1	Gr	Barcode	€
100	30	30	110	028202	65,00
		38	120	028204	
200	30	30	215	028206	69,00
		38	225	028208	
300	30	30	320	028210	73,00
		38	330	028212	
400	30	30	425	028214	78,00
		38	435	028216	
500	30	30	530	028218	84,00
		38	540	028220	
600	30	30	635	028222	88,00
		38	645	028224	
700	30	30	740	028226	92,00
		38	750	028228	
800	30	30	845	028230	96,00
		38	855	028232	
900	30	30	950	028234	102,00
		38	960	028236	
1.000	30	30	1.055	028238	106,00
		38	1.065	028240	

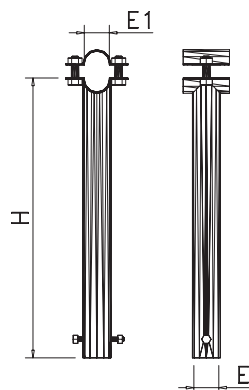

Tirantes para balanzas

Rods for scales
Tringles pour balances

Defensa de esquina tubular 90°

Bumper bar for corner 90°
Pare-choc pour coin 90°



Características:

Desmontable.
Fabricadas en tubo de $\varnothing 48.3$ mm.
AISI 304.
Fijación mediante casquillos.

Characteristics:

Detachable.
Made with tube $\varnothing 48.3$ mm.
AISI 304.
Assembled by means of ferrules

Caractéristiques:

Détachable.
Fabriquées avec tube de $\varnothing 48.3$ mm.
AISI 304.
Fixation par bagues.

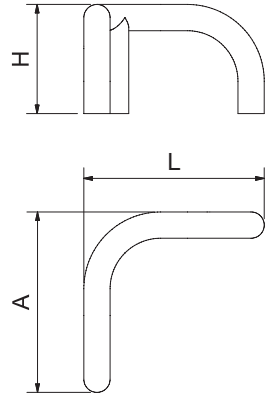

H	A	L	Gr	Barcode	€
220	340	340	1.150	425402	154,00

Soportes de suelo

Floor supports
Supports sur plancher

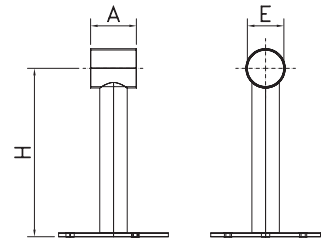
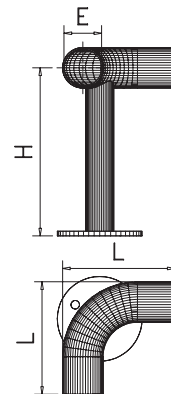

H	L	E	Gr	Barcode	€
200	90	30	695	029002	104,00
	210	38	990	029004	110,00
250	90	30	745	029006	110,00
	210	38	1.040	029008	115,00
300	90	30	795	029010	115,00
	210	38	1.090	029012	120,00

H	A	E	Gr	Barcode	€
200	50	30	600	028802	66,00
		38	630	028804	
250	50	30	650	028806	71,00
		38	680	028808	
300	50	30	700	028810	77,00
		38	730	028812	

Aparcamiento para carros
 Parking for shopping trolley
 Stationnement pour caddies

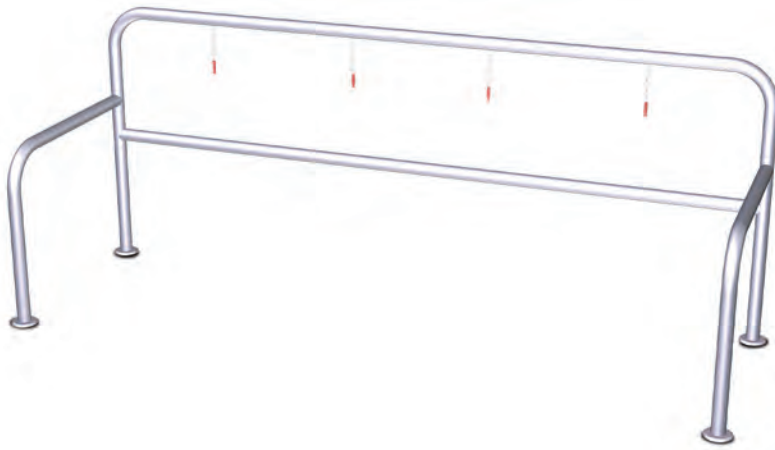

Max. 615mm Max. 615mm Max. 615mm Max. 615mm

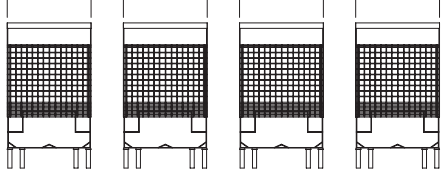

Max. 615mm

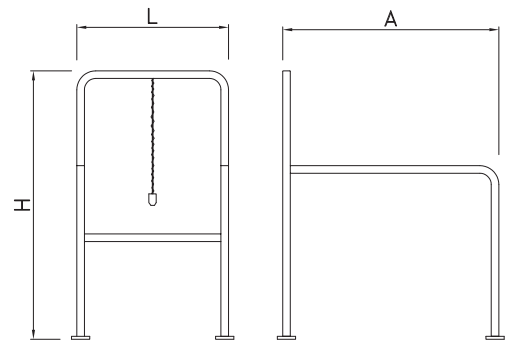
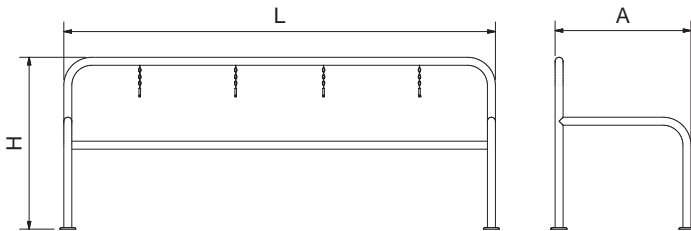
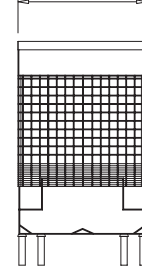

L	A	H				€
800	800	1.100	1	5,50	420602	460,00
1.800	800	1.100	2	7,50	420606	610,00
2.000	800	1.100	3	10,50	420608	750,00
2.700	1.000	1.100	4	12,00	420604	840,00

Plaqueta
 Plate
 Plaque

H	L	A			€
100	40	5	135	224602	9,00

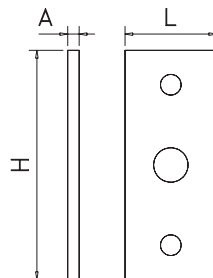

Concepto		€
Concepto Concept Concept		
Plaqueta soldada Soldered plate Plaque soudée	029604	27,00

Plaqueta redonda
 Round plate
 Plaque ronde

D	d	A			€
120	30	4	340	228806	15,00

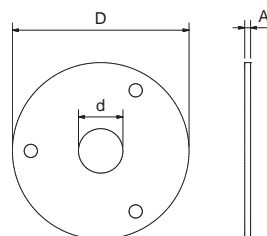

Soporte jamón RT

Ham holder RT
Support jambon RT



Novedad
ew
ouveau

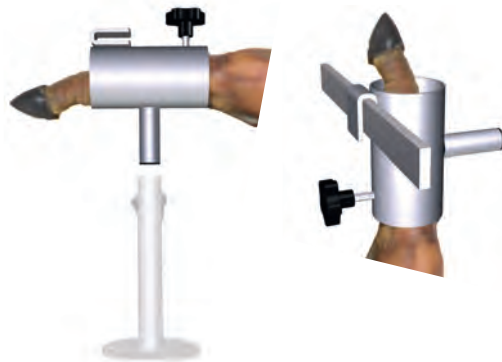
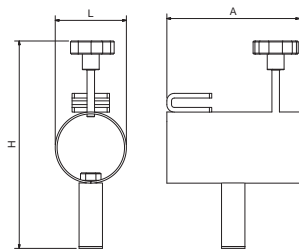

L	A	H	Gr	Barcode	€
75	140	220	800	041812	65,00

Útil para sujeción de jamones

Ham holder tool
Outil pour porter jambons

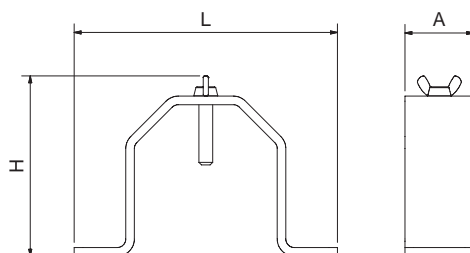

L	A	H	Gr	Barcode	€
153	40	105	400	024250	110,00

Tubos en escuadra

Pipe at right angle
Tube en cornière

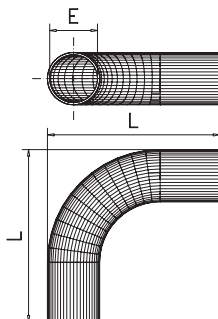

E	L	Gr	Barcode	€
30	90	195	429002	29,00
38	210	490	429004	31,00

Tubos en forma de " T "

Pipe in " T "
Tube dans " T "

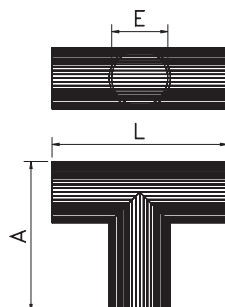
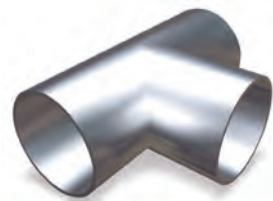

E	L	A	Gr	Barcode	€
30	110	70	160	425002	39,00
38	100	70	185	425004	61,00

Cruces para tubo

Pipe intersections
Intersections pour tube

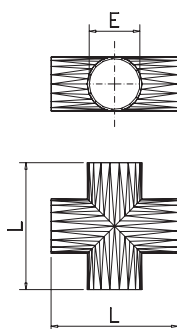

E	L	Gr	Barcode	€
30	112	210	425202	82,00
38	110	340	425204	85,00

" U " sencilla
Simple " U "
" U " simple

H	A	E	Gr	€
50	40	10	155 029606	10,50

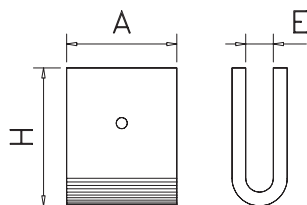

Concepto	€
Concept	
Concept	
"U" sencilla soldada	029602 34,00
Soldered single "U"	
"U" simple soudée	

" U " en doble T
" U " in double T
" U " en double T

H	A	L	E	Gr	€
50	40	100	10	445 029202	76,00

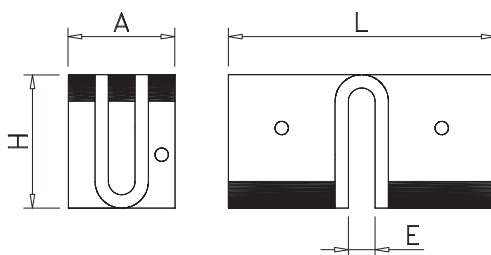

" U " en forma de T
" U " in T
" U " dans T

H	A	L	E	Gr	€
50	40	50	10	295 029402	34,00

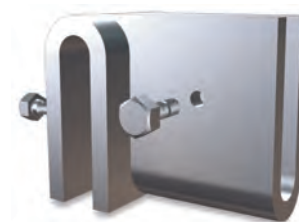
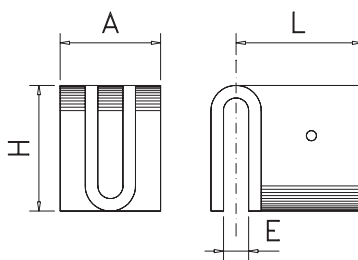

" U " mixta en forma de T
T Mixed " U "
" U " mixte dans T

H	A	L	E	E1	Gr	€
50	40	60	10	30	175 029302	38,00
50	40	60	10	38	180 029304	44,00

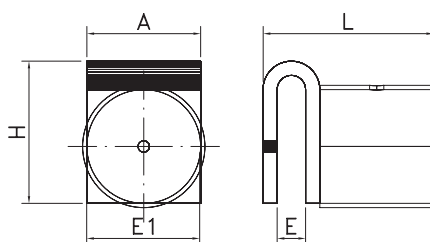



Perfil paragolpes ángulo exterior de fibra blanca

White polyethylene fender plinth for exterior angle
Pare-chocs mural d'angle extérieur en fibre blanche



Novedad
ew
ouveau

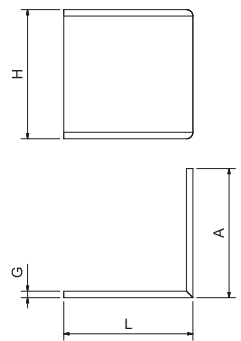

L	A	H	G	Gr	Barcode	€
200	200	200	10	80	434020	17,00

Perfil paragolpes ángulo interior de fibra blanca

White polyethylene fender plinth for interior angle
Pare-chocs mural d'angle intérieur en fibre blanche

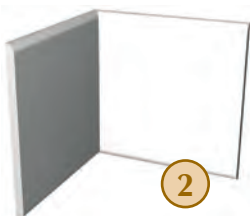

Novedad
ew
ouveau

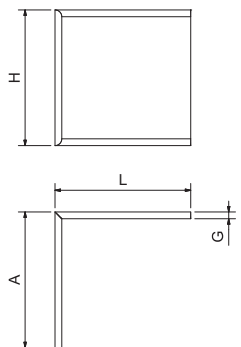

L	A	H	G	Gr	Barcode	€
200	200	200	10	80	434022	17,00

Perfil paragolpes recto de fibra blanca

Straight white polyethylene fender plinth
Pare-chocs mural en fibre blanche



Novedad
ew
ouveau

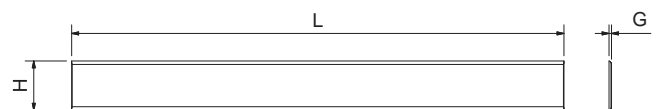

L	H	G	Gr	Barcode	€
2.000	200	10	400	434024	42,00

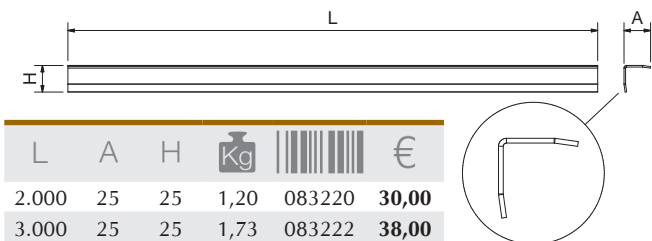

L	A	H	Kg	Barcode	€
2.000	25	25	1,20	083220	30,00
3.000	25	25	1,73	083222	38,00

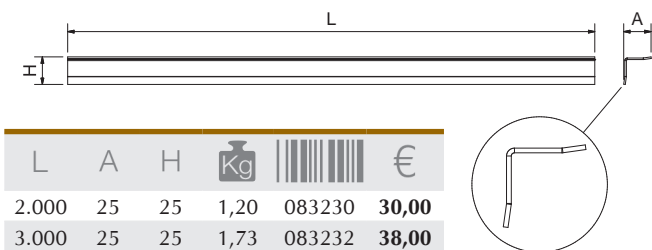

L	A	H	Kg	Barcode	€
2.000	25	25	1,20	083230	30,00
3.000	25	25	1,73	083232	38,00

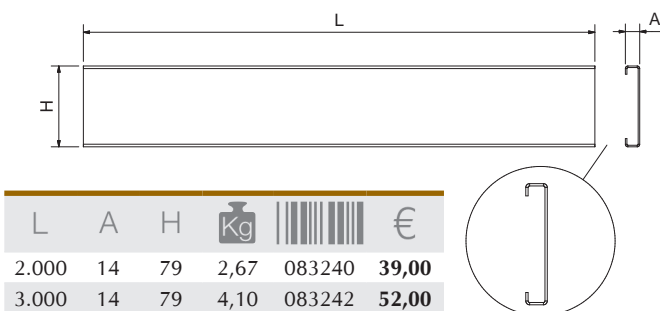

L	A	H	Kg	Barcode	€
2.000	14	79	2,67	083240	39,00
3.000	14	79	4,10	083242	52,00

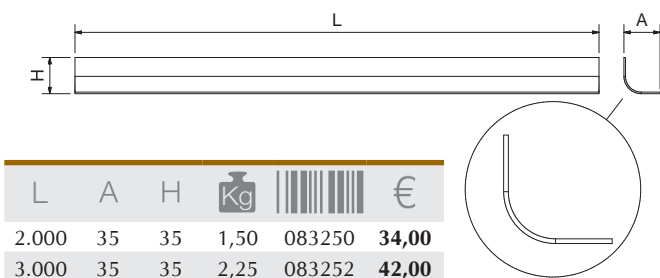

L	A	H	Kg	Barcode	€
2.000	35	35	1,50	083250	34,00
3.000	35	35	2,25	083252	42,00

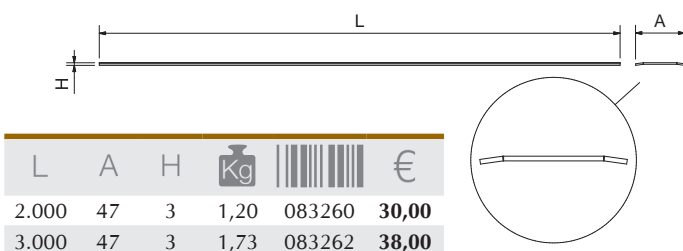

L	A	H	Kg	Barcode	€
2.000	47	3	1,20	083260	30,00
3.000	47	3	1,73	083262	38,00

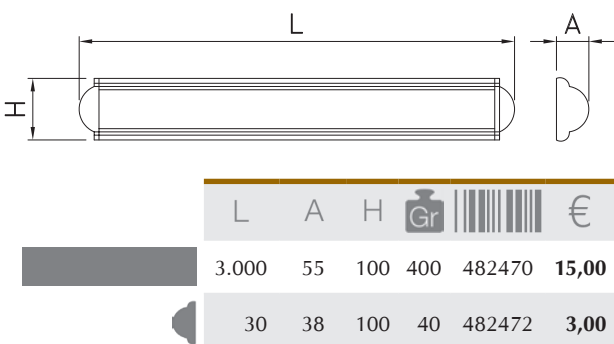

L	A	H	Gr	Barcode	€
3.000	55	100	400	482470	15,00
30	38	100	40	482472	3,00

Guardavivos exterior de acero inoxidable

Stainless steel external corner guard
Baguette d'angle externe en acier inoxydable



Guardavivos interior de acero inoxidable

Stainless steel internal corner guard
Baguette d'angle interne en acier inoxydable



Zócalo de acero inoxidable

Stainless steel skirting board
Plinthe en acier inoxydable

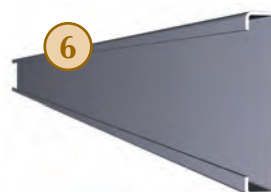

Zócalo curvo de acero inoxidable

Stainless steel curved corner guard
Baguette d'angle en acier inoxydable courbe

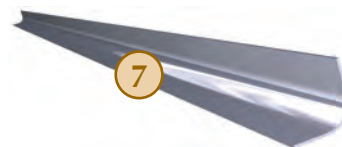

Tapajuntas de acero inoxidable

Stainless steel cover strip
Barre de seuil en acier inoxydable



Perfil paragolpes curvo mural de plástico

Plastic wall bumpers
Pare-chocs mural en plastique



Ganchos pesadores

Weighing hooks
Crochets peseurs



10 Kg



200 Kg

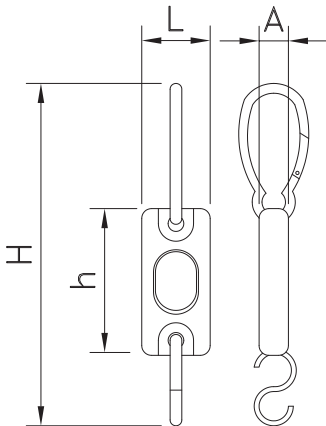

	10 Kg. (422602)	200 Kg. (422604)
Peso en Kg., lb. y oz. Weighing in Kg., lb and oz. Poids en Kg., lb et oz.	<input checked="" type="checkbox"/>	<input checked="" type="checkbox"/>
Funciones: ON/OFF, Tara, fijación de peso automática. Functions: ON/OFF, Tare, Automatic weightfixation. Fonctions: ON/OFF, Tara, Fixation du poids automatique.	<input checked="" type="checkbox"/>	<input checked="" type="checkbox"/>
Termómetro. Thermometer. Thermomètre.	<input checked="" type="checkbox"/>	---
Indicador de batería. Battery indicator. Témoin de niveau de batterie.	<input checked="" type="checkbox"/>	<input checked="" type="checkbox"/>
Desconexión automática. Auto switch off. Mise en veille automatique.	<input checked="" type="checkbox"/>	<input checked="" type="checkbox"/>
Carcasa en ABS. ABS housing. Carter en ABS.	<input checked="" type="checkbox"/>	<input checked="" type="checkbox"/>
Gancho plegable, en acero inoxidable. Folding hook, in stainless steel. Crochet pliable, en acier inoxydable.	<input checked="" type="checkbox"/>	<input checked="" type="checkbox"/>
Pantalla LCD. LCD display. Écran LCD.	4 digit / 14 mm.	5 digit / 16 mm.
Retroiluminación. Backlighted. Retro-éclairé.	---	<input checked="" type="checkbox"/>
Número de teclas. Number of keys. Nombre de touches.	4	3
Nº Pilas incluidas. Number of batteries included. Piles incluses.	3x AAA	2x CR2032
Mosquetón de fijación superior y gancho abierto inferior. Includes snap harness for superior fixing and inferior hook. Inclus manille supérieure et crochet ouvert inférieur.	---	<input checked="" type="checkbox"/>

L	A	H	h	Kg	Gr	Barcode	€
52	20	160	90	10	120	422602	35,00
70	30	350	150	200	500	422604	143,00

Tornillos cabeza hexagonal rosca métrica

Bolts with hexagonal head and metric threads
Vis de tête hexagonale à filetage métrique

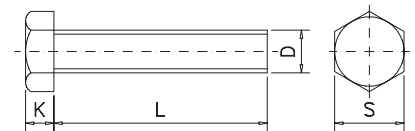

L	D	S	K	Gr	Barcode	€
16	M4	7	2,8	3,0	421002	0,11
35	M4	7	2,8	6,0	421003	0,18
8	M5	8	3,5	0,7	421004	0,11
12	M5	8	3,5	1,0	421006	0,11
12	M6	10	4,0	3,0	421007	0,11
40	M6	10	4,0	8,0	421008	0,16
50	M6	10	4,0	9,0	421010	0,33
12	M8	13	5,3	7,0	421012	0,24
16	M8	13	5,3	8,0	421014	0,26

L	D	S	K	Gr	Barcode	€
25	M8	13	5,3	11,0	421016	0,32
40	M8	13	5,3	15,0	421018	0,46
50	M8	13	5,3	18,0	421020	0,55
60	M8	13	5,3	21,0	421022	0,64
80	M8	13	5,3	27,0	421024	0,84
100	M8	13	5,3	33,0	421026	1,10
70	M10	17	6,4	40,0	421028	0,76
80	M10	17	6,4	44,0	421030	0,84
100	M10	17	6,4	56,0	421032	0,96

Tornillos barraqueros con embellecedor

Blind nut with self-tapping bolts
Ecrou de trou borgne à vis à bois



L	D	Gr	Barcode	€
40	6	20	029702	2,50
65	10	30	029704	20,00

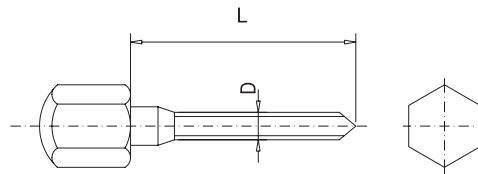

Tirafondos cabeza hexagonal

Bolts with hexagonal head
Tire-fond de tête hexagonale



L	D	Gr	Barcode	€
40	6	10	421034	0,39
55	6	15	421035	0,55
60	8	20	421036	0,84
70	6	20	421033	0,58

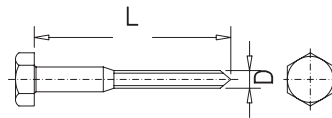

Tornillos rosca chapa

Self-tapping screws
Vis filetage tôle



L	D	S	K	Gr	Barcode	€
10	3,5	7,0	2,00	1,0	421042	0,19
19	3,9	7,5	2,80	2,0	421039	0,21
22	5,5	10,5	4,10	6,0	421037	0,25
22	4,8	9,5	3,55	3,0	421038	0,25
32	3,9	7,5	2,80	2,2	421040	0,23

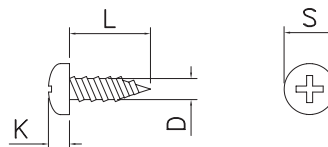

Tornillo cabeza allen rosca métrica

Screw with allen head and metric thread
Vis avec tête allen et filet métrique



L	D	S	Gr	Barcode	€
12	M6	5	12	421043	0,50
25	M10	8	25	421044	0,61

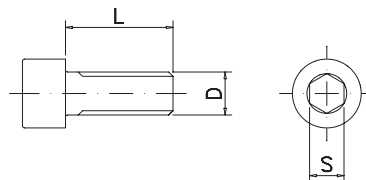

Tacos de plástico nylon

Nylon-plastic plug
Cheville en plastic-nylon



D	L	Barcode	€
6	30	409822	0,09
8	40	409824	0,11
10	50	409826	0,29

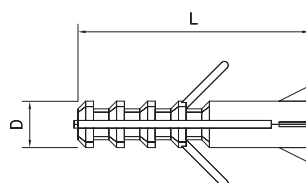

Alcayata

Square bend-screw
Gond à clover

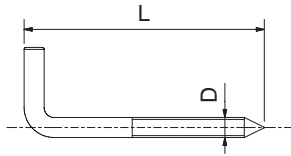

L	D	Gr	Barcode	€
60	5	10	421240	1,30

Tornillo pasante con tuerca y contratuerca rosca métrica

Screw with nut and conternut with metric threads
Vis perçante avec écrou et cotre-écrou à filetage métrique

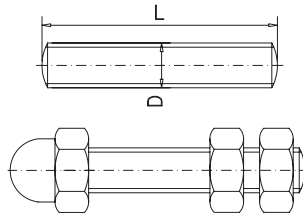

L	D	Gr	Barcode	€
200	M8	80	029502	6,00

Tornillo cabeza mariposa tipo americano

American shape wing screw
Vis à oreilles type américain

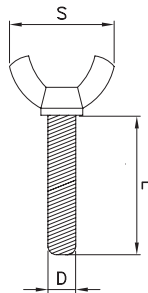

S	L	D	Gr	Barcode	€
30	25	8	17,00	421047	0,80
30	50	8	17,26	421046	0,90

Taco galvanizado para techo tipo balancín

Galvanised plug for roof seesaw model
Cheville galvanisé pour toit modèle balancier

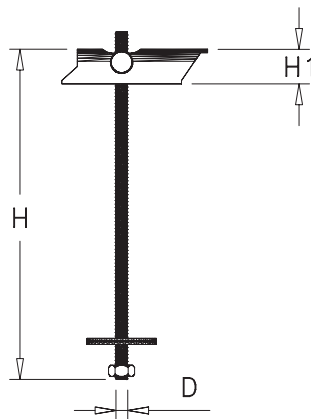

H	H1	D	Gr	Barcode	€
200	20	M8	135	421422	10,50

Varillas roscadas rosca métrica

Rod with metric threads
Tige spirale à filetage métrique

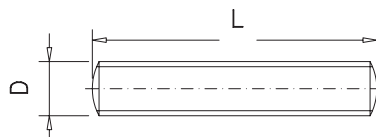

L	D	Gr	Barcode	€
1.000	M8	310	421202	5,00
1.000	M10	495	421204	8,00

Embellecedor para tocho

Blind nut and metric threads
Ecrou de trou borgne à filetage métrique

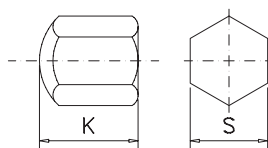

D	S	K	Gr	Barcode	€
M14	22	25	50	029902	5,00

Tuercas ciegas hexagonales rosca métrica

Blind nuts with hexagonal head and metric threads
Ecrous borgne hexagonale à filetage métrique

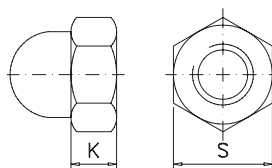

D	S	K	Gr	Barcode	€
M4	7	3,5	1	421064	0,25
M5	8	3,5	2	421066	0,28
M8	13	5,3	8	421070	0,50
M10	17	6,5	18	421072	1,02
M14	22	8,8	35	421076	4,64

Tuerca ciega hexagonal con autoseguro

Hexagon self-locking nut with cup
Ecrou borgne hexagonal avec auto-sécurité

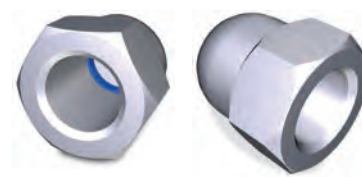
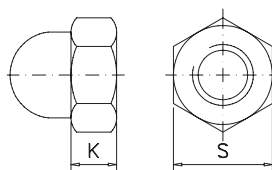

Novedad
ew
ouveau

D	S	K	Gr	Barcode	€
M6	10	5	4	421068	0,70

Tuercas hexagonales rosca métrica

Nuts with hexagonal head and metric threads
Ecrous hexagonale à filetage métrique

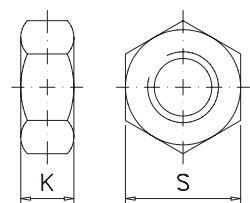

D	S	K	Gr	Barcode	€
M4	7	2,8	0,7	421050	0,10
M5	8	3,5	1	421052	0,32
M6	10	4,0	2	421054	0,52
M8	13	5,3	4	421056	0,11
M10	17	6,5	10	421058	0,24
M12	19	10,0	16	421060	0,30
M14	22	8,8	22	421062	0,35

Tuerca hexagonal rosca metrica con autoseguro

Hexagonal nut with metric thread and lock
Écrou hexagonale autobloquant à filletage métrique

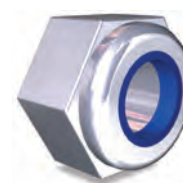
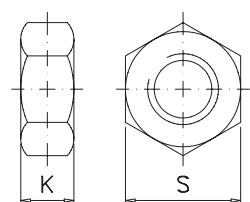

D	S	K	Gr	Barcode	€
M5	8	5,0	1	421078	0,40
M6	10	6,0	2	421080	0,60

Tuerca mariposa tipo americano

American shape wing nut
Écrou à oreilles type américain

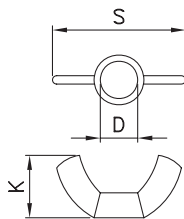

S	K	D	Gr	Barcode	€
30	15	M8	5,6	421082	0,45

Remaches tubulares

Tubular rivets
Rivetages tubulaires

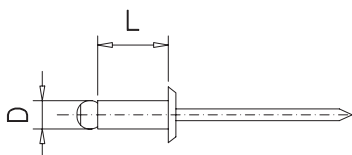

L	D	Gr	Barcode	€
10	3,2	1	421230	0,17
8	4,8	2	421233	0,35

Bisagra de piano inox

Piano hinge
Charnière de piano



L	A	Gr	Barcode	€
1.820	38	1.200	421250	90,00

Arandelas

Plain washer
Rondelle plate

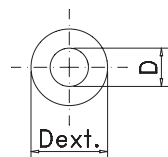

Typo Type	D	D ext.	Gr	Barcode	€
Plana Plane Plain	M6	12,0	1,0	421215	0,05
	M8	16,0	2,0	421216	0,06
	M10	20,0	3,0	421218	0,15
	M12	19,5	2,7	421206	0,09
	M20	37,0	14,0	421220	0,40
Especial Special Special	M8	24,0	5,0	421221	0,12
	M10	30,0	11,0	421223	0,24
	M12	30,0	25,0	421208	0,90
	M20	60,0	64,0	421222	1,10
Grower Grower Grower	M4	6,2	0,2	421210	0,03
	M5	9,2	0,3	421212	0,03
	M8	14,8	1,0	421214	0,06
	M10	18,1	2,5	421213	0,08

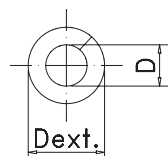
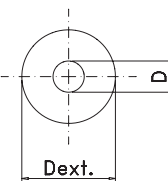

TAJOS

Chopping blocks and fibre boards
Billots de découpe et plaques

NOVEDADES News Nouveautés

Tabla de corte alta precisión High precision cutting board Plaque de coupe de haute précision	83
Estropajo para tablas de corte Cutting board scraper Éponges pour plaque de coupe	85
Enrollador de maki higiénico Sushi rolling mat, hygienic Enrouleur de maki hygiénique	90





Detalle de portacuchillos de chapa y papelería adosados a tajo de troceo.
Detail of knife-holder in stainless steel sheet and wastepaper bin fixed to chopping block.
Détail de porte-couteaux en plaque et de corbeille à papier adapté au billot.

Manufacturing characteristics of all our blocks:

Frame constructed from stainless steel.

Shelves made from acoustically treated stainless steel sheet, with no wood fitted internally.

Adjustable legs for a higher stability on any surface

Optionally, the following accessories can be installed:

Drawers	462
Knife holders disinfectant	355
Lateral wastepaper bin	378
Knife holders	132
Wheels	466
Lateral waste receptacle for scraps	435
Antivibrator cover for adjustable blocks	469
Coloured fibres	80
Elevation kit	78



Detalle de rueda de acero inoxidable con freno acoplada a pata de tajo de troceo.
Detail of wheel in stainless steel with brake fixed to chopping block leg.
Détail de roue en acier inoxydable avec frein installé dans pied de billot.

Características de fabricación de todos nuestros tajos:

Bastidor construido en tubo de acero inoxidable.

Entrepaño en chapa de acero inoxidable insonorizado y sin madera pegada en su interior.

Pies regulables para una mayor estabilidad en cualquier tipo de suelo.

Opcionalmente se pueden instalar los siguientes accesorios:

Cajones	462
Desinfectadores de cuchillos	355
Papelería lateral	378
Portacuchillos	132
Ruedas	466
Tolva lateral evacuación de desperdicios	435
Funda antivibradora para taco regulable	469
Fibras de colores	80
Kit de elevación	78



Caractéristiques de fabrication de tous nos billots:

Châssis fabriqué en tube d'acier inoxydable.

Tablettes fabriquées en plaque d'acier inoxydable insonorisées et sans bois collé à l'intérieur.

Pieds réglables pour une plus grande stabilité sur n'importe quelle surface.

Optionnellement on peut installer les suivantes accessoires:

Tiroirs	462
Stérilisateurs de couteaux	355
Corbeille à papier latéral	378
Porte couteaux	132
Roues	466
Trémie latéral d'évacuation des déchets	435
Base anti-vibrateur pour taquets réglables	469
Plaques de couleurs	80
Kit d'élévation	78



Detalle de pata con pie regulable con funda antivibradora.
Detail of adjustable feet with antivibrator cover.
Détail de pie réglable avec base anti-vibrateur.

Tajos de troceo de fibra lastrados

Fibre weighted chopping blocks
Billots lestés en fibre



Características:

Nuevo diseño del sistema de lastrado que garantiza una mayor higiene.

Los tajos blindados y lastrados Fricosmos están especialmente diseñados para sustituir a los troncos y tajos de madera, principalmente por las siguientes cualidades:

Fibra polietileno calidad P-500 de 50 mm de grosor.

Gran peso, que evitará en gran medida el sonido y las vibraciones de éste al ser golpeado, favoreciendo la estabilidad.

Characteristics:

New design of the ballasting system that guarantees better hygiene.

The reinforced, weighted Fricosmos chopping blocks are especially designed to replace the wooden chopping blocks and boards mainly because of the following qualities: P-500 quality and 50mm thick polyethylene fibre.

Its heaviness reduces noise and vibrations and keeps it steady.

Caractéristiques:

Nouveau design du système de lestage qui garantit une plus grande hygiène.

Les billots blindés et lestés Fricosmos sont spécialement préparés pour remplacer les troncs d'arbres et les billots en bois, grâce surtout à leurs qualités:

Plaque de polyéthylène qualité P-500 de 50 mm d'épaisseur.

Poids solide, qui évitera en grande mesure le bruit et les vibrations au moment de frapper, ce qui favorise la stabilité.

L	A	H	F	E		Kg		€
400	400	900	145	200		31,0	030102 030152	345,00
450	450	900	145	200		38,0	030104 030154	391,00
500	500	900	145	200		41,0	030106 030156	420,00
600	400	900	145	200		39,0	030108 030158	448,00
700	500	900	145	200		51,0	030110 030160	560,00
1.000	500	900	145	200		67,0	030112 030162	855,00

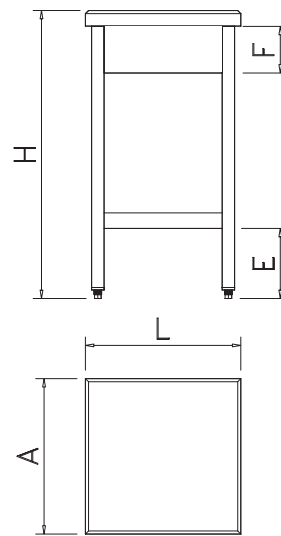

Es posible suministrarlos con fibra de diferente color. (Consultar)

There is the possibility of supplying them with other colours of fibre. (Ask for it)

Possibilité d'en fournir avec autres couleurs de fibre. (Demandez)

Características:

Los tajos de fibra Fricosmos incorporan de serie polietileno calidad P-500 de 50 mm de grosor.

Characteristics:

Fricosmos fibre blocks come as standard with P-500 quality and 50 mm thick polyethylene.

Caractéristiques:

Les billots en fibre Fricosmos incorporent de série polyéthylène de qualité P-500 de 50 mm d'épaisseur.

L	A	H	F	E		Kg		€
400	400	900	145	200		15,1	030302 030352	295,00
450	450	900	145	200		17,8	030304 030354	320,00
500	500	900	145	200		20,9	030306 030356	330,00
600	400	900	145	200		20,3	030308 030358	355,00
700	500	900	145	200		27,3	030310 030360	433,00
1.000	500	900	145	200		36,9	030312 030362	523,00

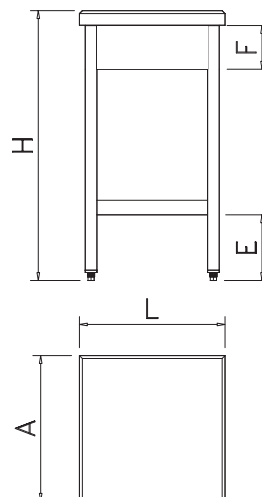

Es posible suministrarlos con fibra de diferente color. (Consultar)

There is the possibility of supplying them with other colours of fibre. (Ask for it)

Possibilité d'en fournir avec autres couleurs de fibre. (Demandez)

Tajo de troceo de fibra serie GE

Fibre chopping block, support GE model
Billot en fibre, modèle GE



Características:

Este tajo incorpora de serie polietileno calidad P-500 de 70 mm de grosor.

Characteristics:

Fricosmos fibre blocks come as standard with P-500 quality and 70 mm thick polyethylene.

Caractéristiques:

Les billots en fibre Fricosmos incorporent de série polyéthylène de qualité P-500 de 70 mm d'épaisseur.

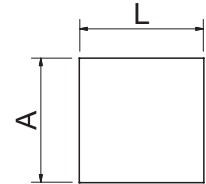
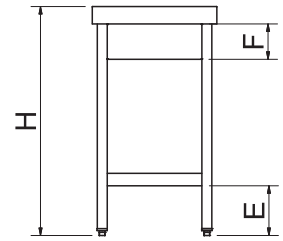

040602 75,00 132

Portacuchillos para adosar con
envolvente.

Mounted knife holder with wrapping
Porte-couteaux pour adosser avec enveloppant

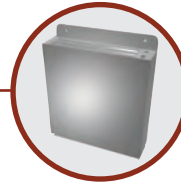

L	A	H	F	E		Kg		€
500	500	920	145	200		25,90	032008	395,00
500	500	920	145	200		25,90	032010	395,00
500	500	920	145	200		25,90	032012	395,00

Tajo especial barbacoa

Chopping block specially for barbecues
Billot spécial pour barbecues



Contenido:

- 1 Soporte de acero inoxidable con faldón y entrepaño.
- 1 Fibra de polietileno alta densidad. Dimensiones 600x400x50 mm.
- 1 Estante de apoyo de 325x325 mm, de acero inoxidable
- 1 Kit para utensilios de acero inoxidable con 10 ganchos.
- 1 Cestillo porta-objetos de 105x105x145 mm.
- 1 Adaptador para contenedor de desperdicios, de acero inoxidable.
- 1 Contenedor de desperdicios de 26 lts.
- 2 Ruedas giratorias sin freno, de acero inoxidable y superficie de rodadura de nylon.
- 2 Ruedas giratorias con freno, de acero inoxidable y superficie de rodadura de nylon.

Content:

- 1 frame of stainless steel with fringe and shelf.
- 1 high density polyethylene board, dimensions 600x400x50 mm.
- 1 stainless steel shelf for support of 325x325 mm.
- 1 tool holder kit in stainless steel with 10 hooks.
- 1 tool holder basket of 105x105x145 mm.
- 1 waste bin container adaptor in stainless steel.
- 1 waste bin container of 26 liters
- 2 revolving wheels in stainless steel, without brakes and rolling surface in nylon.
- 2 revolving wheels in stainless steel, with brakes and rolling surface in nylon.

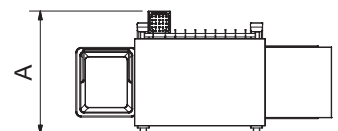
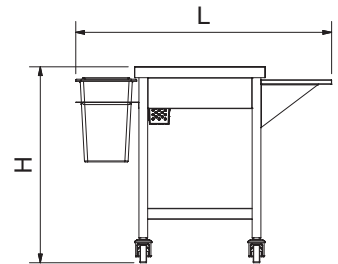

Contenu:

- 1 châssis en acier inoxydable avec support à pan et étage.
- 1 plaque en polyéthylène d'haute densité et dimensions 600x400x50 mm
- 1 étagère en acier inoxydable de 325x325 mm pour appui des objets
- 1 kit pour suspendre outils en acier inoxydable avec 10 crochets.
- 1 panier pour suspendre objets de 105x105x145 mm
- 1 adaptateur en acier inoxydable pour conteneur à ordures.
- 1 conteneur à ordures de 26 litres
- 2 rouelles pivotantes en acier inoxydable, sans frein et surface roulante en nylon.
- 2 rouelles pivotantes en acier inoxydable, avec frein et surface roulante en nylon.



Es posible suministrarlos con fibra de diferente color.
(Consultar)

There is the possibility of supplying them with other colours of fibre.
(Ask for it)
Possibilité d'en fournir avec autres couleurs de fibre. (Demandez)

L	A	H	Kg		€
1.175	565	900	28,5	032002	580,00

Tajos de troceo madera con faldón

Wooden chopping blocks with fringe
Billots en bois avec support inox

Características:

Los tajos de madera Fricosmos incorporan de serie una maza construida con tacos de madera de abedul o encina de 250 mm de espesor.

Characteristics:

Fricosmos wooden blocks come as standard with wooden mass constructed with blocks of birch or holm oak 250 mm thick.

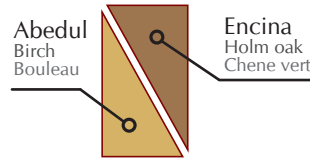

Caractéristiques:

Les billots en bois Fricosmos incorporent de série un bloc fabriqué avec morceaux de bois bouleau ou de chêne vert de 250 mm d'épaisseur.

L	A	H	F	E		Kg		€
400	400	900	145	150		36	031102	412,00
						46	031502	581,00
450	450	900	145	150		45	031104	455,00
						58	031504	674,00
500	500	900	145	150		54	031106	504,00
						69	031506	747,00
600	400	900	145	150		52	031108	504,00
						67	031508	747,00
700	500	900	145	150		75	031110	609,00
						96	031510	947,00
1.000	500	900	145	150		105	031112	930,00
						136	031512	1.305,00

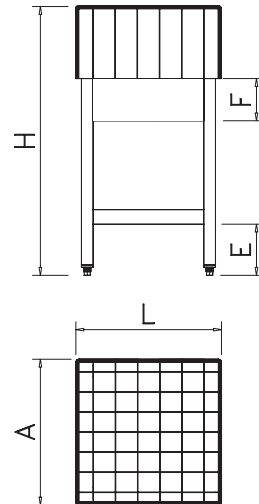

Tajos de troceo madera y fibra con faldón

Wooden and fibre chopping blocks, with fringe
Billots en bois et en fibre avec support inox

Características:

Los tajos de madera y fibra Fricosmos incorporan de serie polietileno calidad P-500 de 50 mm de grosor y maza construida con tacos de madera de abedul de 200 mm de espesor.

Characteristics:

Fricosmos wooden and fibre chopping blocks come as standard with P-500 quality and 50 mm thick polyethylene and wooden mass constructed with birch blocks of 200 mm thick.

Caractéristiques:

Les billots en bois et en fibre Fricosmos incorporent de série Polyéthylène qualité P-500 de 50 mm d'épaisseur et bloc fabriqué avec morceaux de bois bouleau de 200 mm d'épaisseur.

L	A	H	F	E		Kg		€
400	400	900	145	150		30,0	030702	458,00
							030752	
450	450	900	145	150		40,0	030704	565,00
							030754	
500	500	900	145	150		41,0	030706	587,00
							030756	
600	400	900	145	150		52,3	030708	597,00
							030758	
700	500	900	145	150		56,0	030710	693,00
							030760	
1.000	500	900	145	150		106,9	030712	1.103,00
							030762	

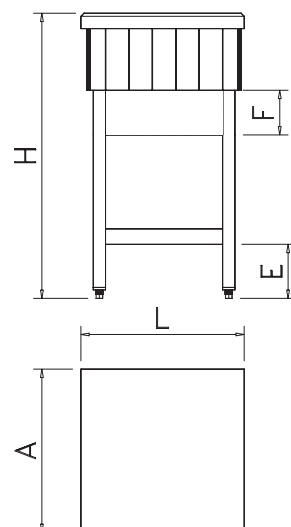

Es posible suministrarlos con fibra de diferente color. (Consultar)

There is the possibility of supplying them with other colours of fibre. (Ask for it)
Possibilité d'en fournir avec autres couleurs de fibre. (Demandez)

Kit de elevación

Elevation kit
Kit d'élévation



Totalmente higiénico
(sin roscas)

Completely hygienic
(No threads)

Parfaitement hygiénique
(Sans filetage)

Características:

La instalación de este novedoso sistema en nuestros tajos, soluciona la necesidad de adaptar la zona de trabajo a la altura de cada usuario, se consigue una mayor comodidad y ergonomía en su uso diario.

Fácil, cómodo y sin herramientas. La regulación se realiza girando la manivela a un lado u otro según se desee mayor o menor altura.

Válido para todos nuestros tajos de corte.

Evita bajas laborales.

Characteristics:

The setting-up of this innovative system in our chopping blocks solves the need to adapt the work surface to the height of each user. You will get comfort and ergonomics in everyday use.

Easy, handy and without tools. The height adjustment is made by turning the handle clockwise or counterclockwise as desired.

Valid for all our chopping blocks.

It avoids work accidents.

Caractéristiques:

Le montage de ce système innovant dans nos billots résout la nécessité d'adapter la surface de travail à la hauteur de chaque utilisateur. Vous obtiendrez le confort et l'ergonomie dans l'utilisation quotidienne.

Facile, pratique et sans outils. Le réglage en hauteur se fait en tournant la poignée d'un sens ou d'un autre comme selon vos besoins.

Valable pour tous nos billots.

Il permet d'éviter des accidents de travail.

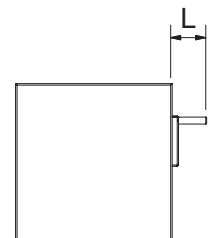
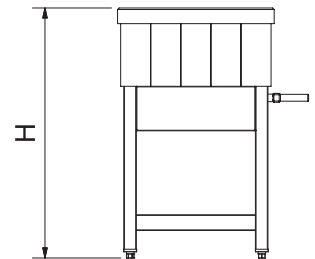

L	H _{max}	H _{min}	Barcode	€
110	1.000	800	033002	1.100,00

Repuesto de mazas

Spare masses
Billots de rechange

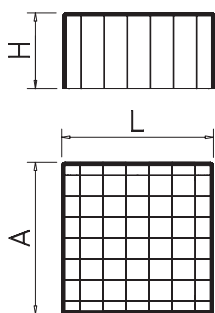

			Madera de abedul Birch wood Bois bouleau			Madera de encina Holm oak wood Bois de chene vert		
L	A	H	Kg	Barcode	€	Kg	Barcode	€
400	400	250	30	433002	213,00	40	433202	344,00
450	450	250	38	433004	226,00	50	433204	425,00
500	500	250	47	433006	267,00	62	433206	500,00
600	400	250	45	433008	267,00	60	433208	500,00
700	500	250	66	433010	353,00	87	433210	685,00
1.000	500	250	94	433012	632,00	125	433212	960,00

Repuesto de mazas para acoplar fibra superpuesta

Spare wooden block to attach fibre on top
Billots en bois de rechange pour accoupler fibre superposée

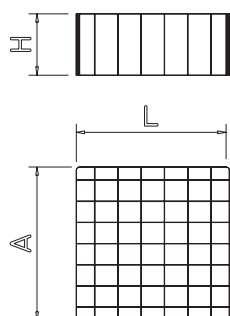

			Madera de abedul Birch wood Bois bouleau		
L	A	H	Kg	Barcode	€
380	380	200	22	433014	154,00
430	430	200	28	433016	172,00
480	480	200	34	433018	207,00
580	380	200	33	433020	207,00
680	480	200	49	433022	293,00
980	480	200	71	433024	401,00

Características:

Estos repuestos de maza están preparados para llevar acoplada en su parte superior una fibra de polietileno.

Characteristics:

These spare wooden blocks are hought only to fix a polyethylene fibre on top.

Caractéristiques:

Ces blocs de rechange été désinnés seulement pour tenir superpose dans la part supérieure une fiber de polyéthylène.

Fibras estándar

Standard fibres
Plaques standard

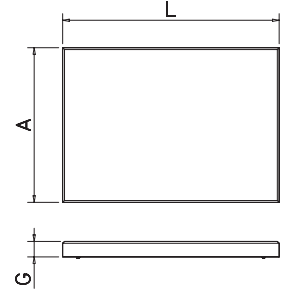

Consulten si desean fibras en otros colores.
Please ask if you would like fibres in other colours.
Consultez-nous si vous voulez plaques en d'autres couleurs.

		Espesor Thick Grosueur											
L	A	G = 15 mm		G = 20 mm		G = 25 mm		G = 30 mm		G = 50 mm		G = 100 mm	
		€	€	€	€	€	€	€	€	€	€		
300	200	431202	8,00	431214	10,00	431240	12,10	431252	14,00				
		431302		431314		431340		431352					
		431402		431404		431410							
		431602	8,50	431604	10,50			431610	15,00				
		431802		431804		431810							
		431902		431904		431910							
				431502		431504		431510					
				431704									
300	300							431255	21,50				
400	200	431204	10,20	431216	13,00	431242	15,70	431254	18,50				
		431304		431316		431342		431354					
400	300	431206	15,00	431218	19,00	431244	23,20	431256	28,00				
		431306		431318		431344		431356					
				431406		431412							
				431606	20,00			431612	32,00				
				431806		431812							
				431906		431912							
				431506		431512							
		431706											
400	400							431261	37,00	431276	61,60		
								431357		431364			
450	450									431282	81,50		
										431368			
500	300	431208	18,00	431220	23,00	431246	29,00	431258	35,00				
		431308		431320		431346		431358					
				431408		431414							
				431608	24,00			431614	38,00				
				431808		431814							
		431908	431914										
		431508		431514									
500	330	431210	19,00	431228	26,00	431248	32,00	431260	38,00				
		431310		431328		431348		431360					
500	400	431211	24,00	431230	31,00	431249	38,50	431262	46,50	431278	76,00		
		431311		431330		431349		431361					
500	500									431284	96,50	431290	268,00
										431370		431384	
600	400	431212	28,00	431232	37,00	431250	46,20	431264	55,50	431280	92,50		
		431312		431332		431350		431362					
600	500			431236	46,50			431270	69,50				
				431336									
700	500									431286	135,00	431292	360,00
										431372			
1.000	400							431266	92,50				
1.000	500									431288	192,50		
										431374			

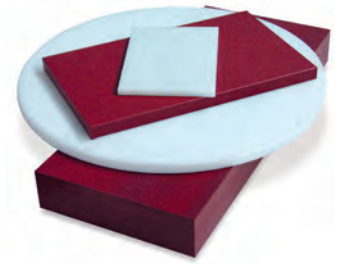

P.ej.: Una fibra roja de 0,525 m x 0,365 m en 30 mm de espesor, haríamos la siguiente operación:
 $0,525 \times 0,365 = 0,1916 \text{ m}^2$

Por lo que su precio de venta al público se obtendría de la siguiente manera:
 $0,1916 \text{ m}^2 \times 258,00 \text{ euros/metro cuadrado} = 49,43 \text{ Euros.}$

For example: for a red fibre of 0.525 mts. x 0.365 mts. and 30 mm. thick we would proceed in the following way

So that the public price should be obtained as follows:
 $0.1916 \text{ m}^2 \times 258.00 \text{ €/m}^2 = 49,43\text{€.}$

Par exemple: pour une fibre rouge de 0.525 mts. x 0.365 mts. et 30 mm. d'épaisseur on procède de la façon suivante.

Tellement que le prix de vente au public serait obtenu comme suivre:
 $0.1916 \text{ m}^2 \times 258.00 \text{ €/m}^2 = 49,43\text{€.}$

Grueso Thick Epaisseur mm.	€ _{m2}	[Barcode]					
10	94,00	432402	432602	432802	432702		432502
15	142,00	432404	432604	432804	432704	432902	432504
20	189,00	432406	432606	432806	432706	432904	432506
25	236,00	432408	432608	432808	432708		432508
30	283,00	432410	432610	432810	432710	432906	432510
40	358,00	432412	432612	432812	432712		432512
50	445,00	432414	432614	432814	432714		432514
60	550,00	432416	432616	432816			
70	682,00	432418	432618	432818			
80	787,00	432420	432620	432820			
90	1.102,00	432422	432622	432822			
100	1.239,00	432424	432624	432824			

Grueso Thick Epaisseur mm.	€ _{m2}	[Barcode]	
10	92,00	432002	432102
15	132,00	432004	432104
20	171,00	432006	432106
25	214,00	432008	432108
30	258,00	432010	432110
40	343,00	432012	432112
50	417,00	432014	432114
60	540,00	432016	432116
70	635,00	432018	432118
80	723,00	432020	432120
90	1.022,00	432022	432122
100	1.122,00	432024	432124



Se pueden instalar tacos antideslizantes en las fibras sin cargo alguno. Indíquelo a la hora de hacer el pedido.
 Antisliding pegs can be installed without additional cost. Please, let us know when placing your order.
 On peut installer chevilles antiglissantes dans les plaques sans coût additionnel. Indiquez-le dans la commande.

Fibras por planchas
Fibres sheets
Fibres par plaque

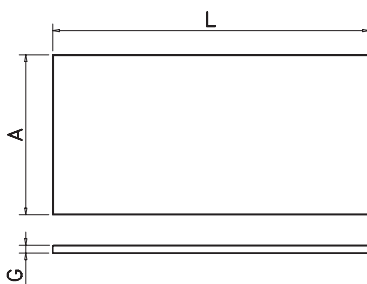
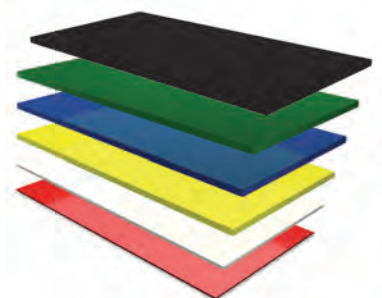

L	A	G	€/ud.	Kg	[Barcode]			
2.020	1.020	10	188,00	20,6	433402	433602	433802	433702
2.020	1.020	15	271,00	30,9	433404	433604	433804	433704
2.020	1.020	20	345,00	42,2	433406	433606	433806	433706
2.020	1.020	25	431,00	51,5	433408	433608	433808	433708
2.020	1.020	30	516,00	61,8	433410	433610	433810	433710
2.020	1.020	40	688,00	82,4	433412	433612	433812	433712
2.020	1.020	50	861,00	103,0	433414	433614	433814	433714
2.020	1.020	60	1.105,00	123,6	433416	433616	433816	
2.020	1.020	80	1.503,00	164,8	433418	433618	433818	
2.020	1.020	100	1.600,00	206,0	433420	433620	433820	

L	A	G	€/ud.	Kg	[Barcode]	
2.020	1.020	10	169,00	20,6	431022	431122
2.020	1.020	15	243,00	30,9	431026	431126
2.020	1.020	20	318,00	41,2	431028	431128
2.020	1.020	25	397,00	51,5	431030	431130
2.020	1.020	30	476,00	61,9	431032	431132
2.020	1.020	40	635,00	82,4	431034	431134
2.020	1.020	50	794,00	103,0	431036	431136
2.020	1.020	60	1.105,00	123,6	431038	431138
2.020	1.020	80	1.473,00	164,8	431040	431140
2.020	1.020	100	2.000,00	206,0	431042	431142

Repuesto de fibras para mesas

Spare fibres for tables
Plaques de rechange pour tables

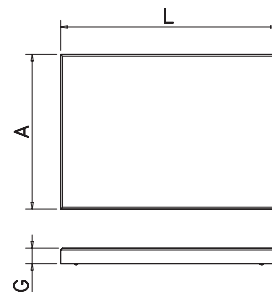

⊛ Con agujero de 150 mm de diámetro.
With 150 mm.diameter hole.
Avec trou de 150 mm.

L	A	G	Kg	Barcode	€
1.000	500	20	10	431223 431323	79,00
1.500	500	20	15	431225 431325	119,00
2.000	500	20	20	431227 431327	158,00
1.000	600	20	12	431229 431329	96,00
1.500	600	20	18	431231 431331	143,00
2.000	600	20	24	431233 431333	191,00
1.000	700	20	14	431235 431335	112,00
1.500	700	20	21	431237 431337	166,00
2.000	700	20	28	431239 431339	223,00

L	A	G	Kg	Barcode	€
1.000	480	20	9,6	432030 432130	79,00 ^N
1.500	480	20	14,4	432032 432132	119,00 ^N
2.000	480	20	19,2	432034 432134	158,00 ^N
1.000	580	20	11,6	432036 432136	96,00 ^N
1.500	580	20	17,4	432038 432138	143,00 ^N
2.000	580	20	23,2	432040 432140	191,00 ^N
1.000	680	20	13,6	432042 432142	112,00 ^N
1.500	680	20	20,4	432044 432144	166,00 ^N
2.000	680	20	27,2	432046 432146	223,00 ^N

L	A	G	Kg	Barcode	€
700	500	20	7,0	431238 431338	70,00* ^N
540	480	20	5,2	431234 431334	56,00* ^N
700	500	40	7,0	431275	135,00* ^N

L	A	G	Kg	Barcode	€
545	500	20	5,0	431217 431653 431317	56,00*
1.000	500	30	14,5	431650	141,00*
760	500	20	7,6	431215 431655 431315	66,00
500	400	20	4,0	431230 431652 431330	31,00
500	400	40	8,0	431274	63,00
500	500	70	17,50	431289 431658 431388	150,00
1.000	300	20	6,0	431222 431322	48,00
1.500	300	20	9,0	431224 431324	71,00
2.000	300	20	12,0	431226 431326	94,00
1.500	400	20	12,0	431293 431376	94,00
2.000	400	20	16,0	431294 431378	123,00
2.500	400	20	20,0	431295 431380	155,00
3.000	400	20	24,0	431296 431382	186,00

Tope para fibras

Fibre brackets
Butée pour plaques



Detalle de fijación a fibra.
Fibre fixing detail.
Détail de fixation.

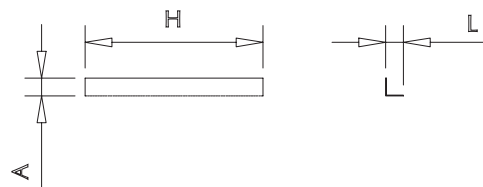

L	A	H	Gr	Barcode	€
400	20	20	102	035002	6,00

Modelo Model Model	G = 20 mm	L	A	Kg	€
1/1	530	325	3,45	434604	27,00
				434612	
				434622	
				434632	
				434642	
1/2	325	265	1,72	434680	15,00
				434652	
				434658	
				434664	
				434670	
1/3	325	176	1,14	434676	16,00
				434684	
				434654	
				434660	
				434666	
2/3	354	325	2,30	434672	11,00
				434678	
				434686	
				434650	
				434656	
				434662	19,00
				434668	
				434674	
				434682	21,00



Tabla de corte alta precisión
High precision cutting board
Plaque de coupe de haute précision

Características:

Diseñadas para los mejores Chefs quienes exigen alta calidad y utilizan cuchillos de alta gama.
Su suave superficie cuida el filo del cuchillo prolongando su vida.
Superficie antideslizante permitiendo cortes más delicados y precisos.
Varios colores. Certificados NSF, para evitar la contaminación cruzada.

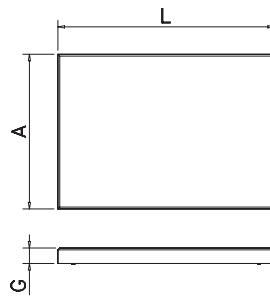
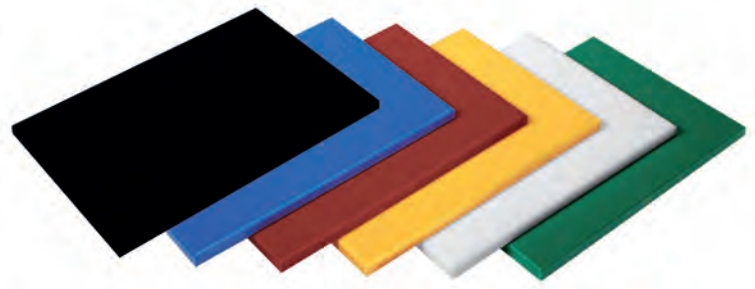
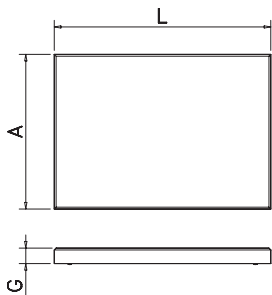

Characteristics:

Intended for the finest Chefs, that use a high range of professional knives and demand the maximum cutting requirements
Smooth surface for the preservation of the edge of the knife to extend its life and effectiveness.
Non-slip surface for and a smooth cutting with the highest accuracy
Several colors. NSF certificates to avoid cross-contamination.



No adecuada para troceo y cortes profundos.
Not suitable for chopping and deep cuts.
Non appropriée pour la découpe et coupes profondes.

L	A	G	Kg	€
340	230	8	600 434492	39,00
500	250	8	900 434494	51,00
340	230	8	600 434496	39,00
500	250	8	900 434498	51,00

Caractéristiques:

Plaque de coupe haute précision
Conçues pour les meilleurs Chefs, avec grande exigence dans la coupe de haute qualité et l'usage de couteaux hauts de gamme.
Sa surface douce conserve le fil du couteau en prolongeant son efficacité.
Surface antidérapante permettant des coupes plus délicates et précises.
Plusieurs couleurs. Certificats NSF pour éviter la contamination croisée.

Tajo-expositor para mostrador de pescadería

Polyethylene cutting board-display for fish counter
Plaque de découpe-exposant en polyéthylène pour étal à poisson

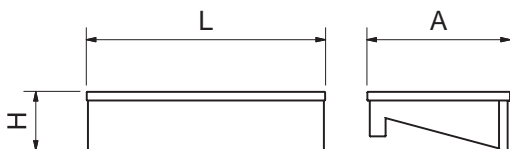

L	A	H	Kg	€
500	300	125	4,70 074460	180,00

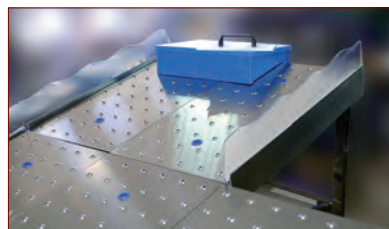

Escurridor para fibras de corte

Chopping board rack
Egouttoir pour planches à découper

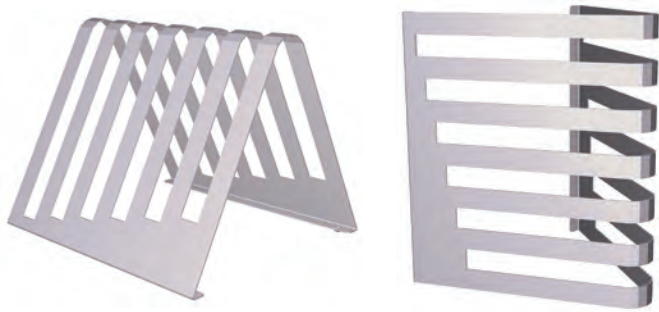

Características:

Este escurridor permite almacenar y organizar las tablas de fibra después de su lavado consiguiendo un secado uniforme por todas sus caras.
El máximo espesor admisible para las fibras es de 25 mm.
Su diseño permite utilizarlo de sobremesa o mural.

Characteristics:

Support for storing and organizing cutting boards after being washed. The system ensures a drying all over the cutting board surface. The maximum permissible thickness of the cutting board is 25 mm. It can be used wall-mounted or standing.

Caractéristiques:

Ce support vous permet de ranger les planches à découper après le lavage. Ce système est parfait pour sécher la totalité de la surface pour une hygiène correcte. L'épaisseur maximale pour les planches à découper est de 25 mm. Il a été conçu pour être utilisé sur la table ou accroché au mur.

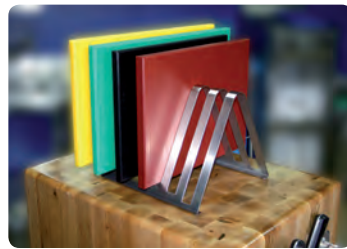

Ejemplos de utilización de forma mural o sobremesa.
Examples of using a wall-mounted or standing.
Exemples d'utilisation sur table ou accroché au mur.

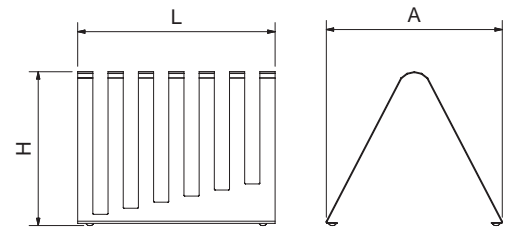

L	A	H	Kg	Barcode	€
325	290	250	1,55	035004	48,00

Cepillo rascador de fibras

Plane for fibres
Rabot pour plaques

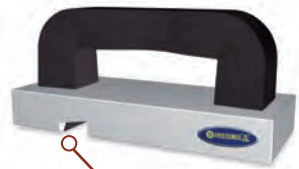

434452 € 2 Op

Juego de cuchillas de repuesto para cepillo rascador.
Spare scraper blades set for plane
Jeu de lames de réchange pour rabot à racloir

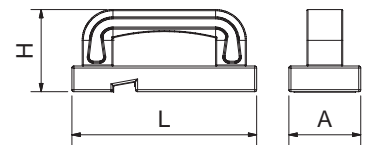
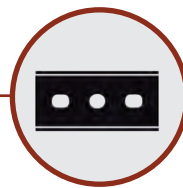

L	A	H	Gr	Barcode	€
180	70	80	500	434450	72,00

Cepillo cerdas inox

Brush with stainless steel bristles
Brosse d'acier inoxydable

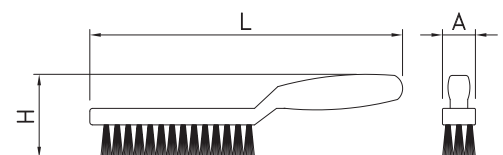

L	A	H	Gr	Barcode	€
285	30	75	172	434474	31,00

Estropajo para tablas de corte

Cutting board scraper
Éponges pour plaque de coupe

Características:

Tecnología patentada de excepcional capacidad de raspado. Borra las manchas duras, el amarilleo por el uso, marcas y mohos de la superficie de las tablas de corte. Además permite suavizar la superficie después del raspado. Este producto está diseñado para un mantenimiento diario de sus tablas de corte, de suma importancia para mantenerlas en óptimas condiciones de higiene.

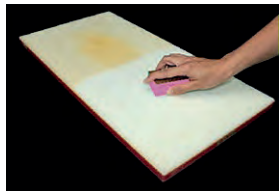
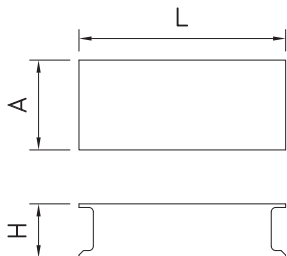

Novedad
New
nouveau

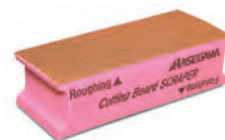

Characteristics:

Patented technology with exceptional scraping capability. It is specially recommended to remove the most stubborn dirt, the yellowing by use or any mark on the surface of cutting boards. It also allows smoothing the surface after scraping. This product is intended for daily maintenance of your cutting boards, which is essential to keep them in optimal hygienic conditions.

Caractéristiques:

Une technologie brevetée de capacité exceptionnelle de grattage. Elle efface les taches dures, le jaunissement par l'usage, les marques et les moisissures de la surface des plaques de coupe. De plus elle permet d'adoucir la surface après le grattage. Ce produit est conçu pour une maintenance quotidienne de vos plaques de coupe, d'importance suprême pour les maintenir dans des conditions parfaites d'hygiène.

L	A	H	Gr	€
115	50	30	18	434006 14,00

Calzo elevador para fibra

Lift block for fibres
Cale pour plaque de découpe



431806 20,00 80

Fibras estándar 400x300x20
Standard fibres 400x300x20
Plaques standard 400x300x20

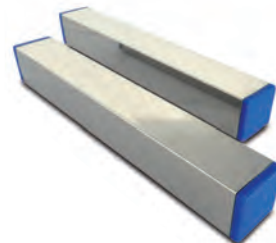
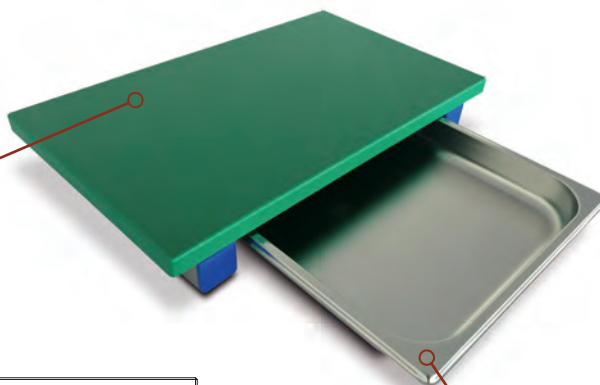

486816 20,78 412

Cubetas Gastronorm lisas 1/1 40 mm.
Non-perforated Gastronorm containers 1/1 40 mm
Bacs Gastronorm lisses 1/1 40 mm



El precio es por pareja.
The pair is included in the price.
Le paire est inclus dans de prix.

L	H	Gr	Kg	€
285	45	2	0,75	035010 24,00
285	85	2	2,90	035012 48,00

Útil de centrado para corte de fruta

Fruit preparation centering accessory
Accessoire de préparation pour centrage de fruit

Características:

Construido en fibra de polietileno, su diseño permite cortar con seguridad sandías, melones, piñas, etc.

Characteristics:

Made from polyethylene. Designed for cutting safely melons, pineapples, watermelons, etc.

Caractéristiques:

Fabriqu  en poly thyl ne. Con u pour couper en toute s curit  les melons, ananas, past ques, etc.

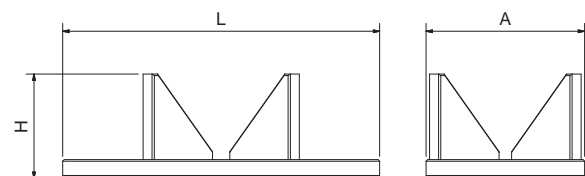

L	A	H	Kg	€
400	200	132	2,10	042202 121,00

Fibra de colores intercambiables

Fibre with interchangeable colour set
Plaque de couleur interchangeable

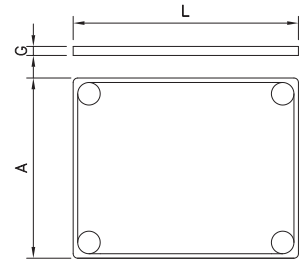
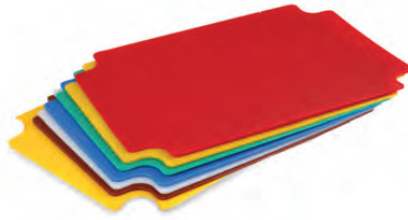
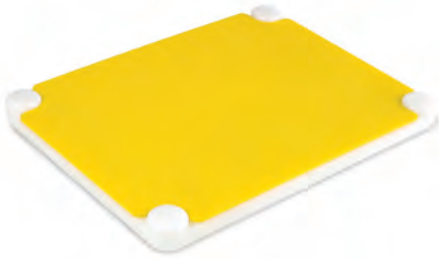

Colores incluidos: Marrón, blanco, azul, verde, amarillo y rojo.

Colors included: Brown, white, blue, green, yellow and red.

Couleurs inclus: Marron, blanc, bleu, vert, jaune et rouge.

L	A	G	Kg	Barcode	€
500	400	20	7,00	434470	59,00

Pack de 6 colores de repuesto

Spare pack of 6 colours
Set de 6 couleurs de rechange

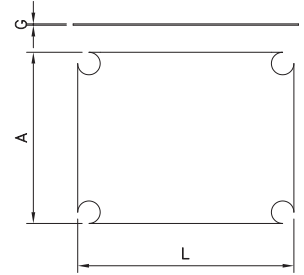
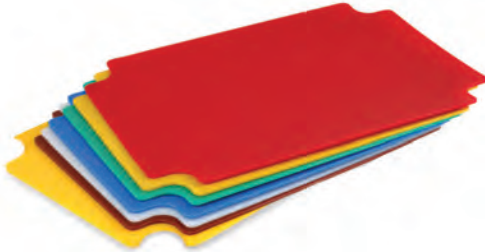

L	A	G	Kg	Barcode	€
500	400	3	3,00	434468	33,00

Tabla de corte/pala de fibra

Cutting board/fiber shovel
Plaque à découper/pelle en fibre



Fabricada en polietileno.
Fácil limpieza (lavavajillas).

Made of polyethylene.
Easy to clean (dishwasher).

Fabriquée en polyéthylène.
Nettoyage facile (lave-vaisselle).

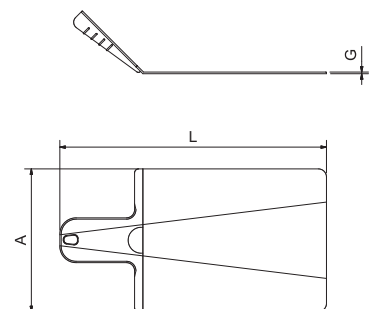

L	A	G	Color	Kg	Barcode	€
380	210	15	Green	0,90	434478	24,00
380	210	15	Red	0,90	434480	24,00
480	270	15	Green	1,50	434482	30,00
480	270	15	Red	1,50	434484	30,00

Panera mixta

Bread combined cutting board
Planche à découper le pain combinée

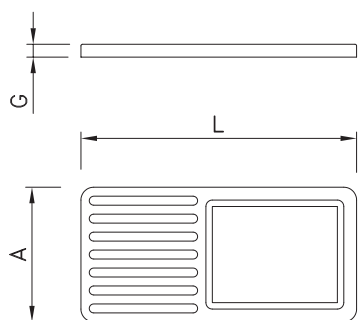

L	A	G	Kg	Barcode	€
430	210	20	1,80	434446	40,00



Fibra para corte de pan

Bread cutting board
Planche à découper le pain

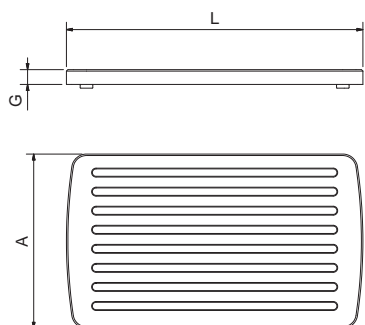

L	A	G	Kg	Barcode	€
400	240	20	1,60	434444	24,00



Fibra para corte de pan con recogemigas

Bread cutting board with crumb collector
Planche à découper le pain avec ramasse-miettes

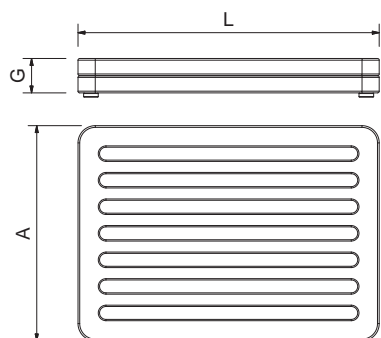

L	A	G	Kg	Barcode	€
350	250	40	3,00	434448	56,00
430	330	40	5,00	434449	73,00



Rodillo

Rolling pin
Rouleau



L	D	Kg	Barcode	€
600	60	1,2	434440	43,00

Mazo de picar

Mincing hammer
Marteau à viande

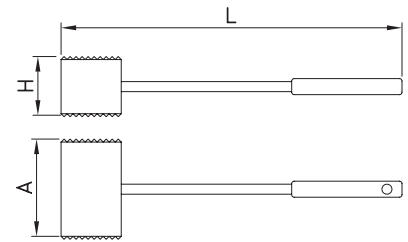

L	A	H	Kg	Barcode	€
340	100	60	1,20	434454	47,00

Remo

Polyethylene mixing paddle
Spatule à mélanger en polyéthylène

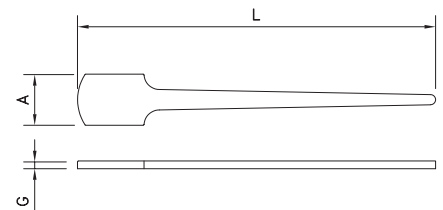

L	A	G	Gr	Barcode	€
450	105	15	200	434402	13,00
700	105	20	400	434404	25,00
995	100	25	600	434406	44,00

Pala de acero inoxidable y polietileno

Stainless steel and polyethylene mixing paddle
Spatule à mélanger en acier inoxydable et polyéthylène

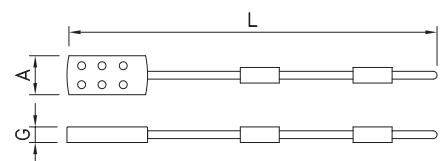

L	A	G	Kg	Barcode	€
1.000	100	25	1,00	434456	71,00
1.400	100	25	1,25	434458	85,00

Útil para picadora
Tool for mincer
Outil pour hachoir

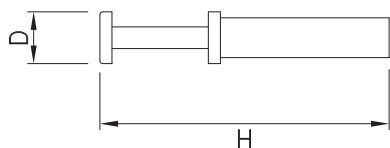

D	H	Gr	Barcode	€
43	240	350	434462	34,00
55	310	600	434464	40,00



Mazo para chino
Tool for strainer
Outil pour chinois étamine

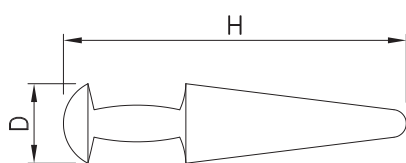

D	H	Gr	Barcode	€
65	280	400	434460	49,00

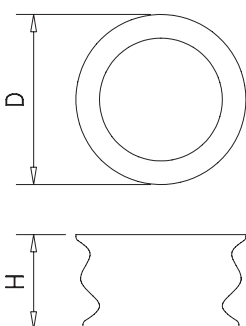

D	H	Kg	Barcode	€
180	100	1,4	434442	125,00

Mortero
Mortar
Mortier

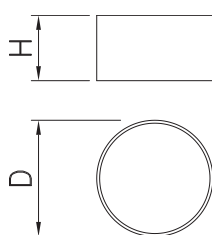

D	H	Gr	Barcode	€
60	45	150	434472	12,00
80	45	150		

Conjunto aros de emplatar
Ring mold set
Set de moules



Triángulo

Triangle
Triangle

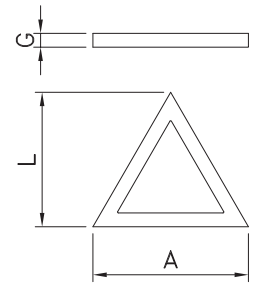

L	A	G	Gr	Barcode	€
390	450	20	500	434476	44,00

Enrollador de maki higiénico

Sushi rolling mat, hygienic
Enrouleur de maki hygiénique

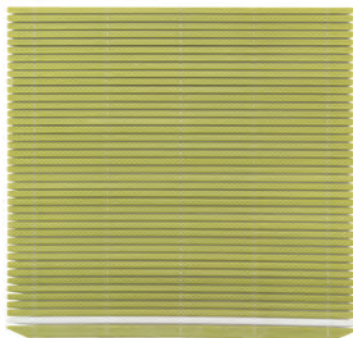

Los mejores enrolladores super-higiénicos de makis con gran capacidad antiadherente del arroz.

Un enrollador revolucionario que no hace uso de las tradicionales varitas de bambú ni del algodón para su cosido, sino de plásticos y monofilamentos avanzados.

No sólo son higiénicos, sino también fáciles de rodar como un enrollador tradicional.

Principales ventajas:

- Apto para lavavajillas.
- No genera astillas o moho negro, como los bambúes convencionales.
- Los monofilamentos del cosido repelen la contaminación.
- Menor probabilidad de que el arroz se adhiera a sus superficies en relieve.
- Rápido secado para poder ser utilizado después del lavado.
- Tan fácil de rodar como los enrolladores convencionales de bambú.

Les meilleurs enrouleurs super-hygiéniques de makis avec une grande capacité antiadhésive du riz. Un enrouleur révolutionnaire qui n'utilise pas les traditionnelles baguettes de bambou ni du coton pour sa couture, sinon des plastiques et des monofilaments avancés. Non seulement ils sont hygiéniques, mais aussi faciles de rouler comme un enrouleur traditionnel.

Avantages principaux :

- Aussi facile de rouler que les conventionnels en bambou.
- Ne génère pas d'éclats ou de moisissure noire, comme les bambous conventionnels
- Les monofilaments de couture repoussent la contamination.
- Une probabilité moindre que le riz s'adhère à ses surfaces en relief.
- Apte pour le lave-vaisselles
- Sèche rapidement pour pouvoir être utilisé après le lavage.

The best makisu ever that are super hygienic and less likely to stick to rice.

A revolutionary makisu that makes use of neither the traditional bamboo nor cotton strings but advanced plastic and monofilaments.

They are not only hygienic but also easy to roll as a makisu.

Designed with several benefits below.

- Dishwasher safe, bleach safe.
- Does not generate splinters or black mold, like the those conventional bamboo ones always does.
- The monofilaments that deter contamination are used for the binding strings.
- Rice less likely to stick to its embossed surfaces.
- Easy to dry so that can be used soon after washing.
- Yet as easy to roll as conventional bamboo ones.

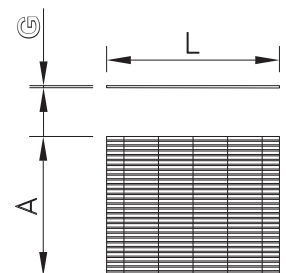

L	A	G	Gr	Barcode	€
250	165	3	110	434486	31,00
250	240	3	160	434488	36,00
250	305	3	200	434490	42,00

CUCHILLERIA

Professional knives

Coutellerie professionnelle

NOVEDADES

News

Nouveautés

Cuchillo francés inyectado Adherent+ French knife with Injected handle Adherent+ Couteau français injecté Adherent+	96	Picadora manual Mincer Hachoir	144
Lira para cortar queso Cheese slicer Lyre pour couper le fromage	99	Cortadora de fiambres manual Cold meat cutter Trancheuse de charcuterie	145
Mundo del jamón World of ham Monde du jambon	100	Biberones de cocina Aqueeze bottle Biberons de cuisine	146
DetectoGrip, serie detectable DetectoGrip, detectable series DetectoGrip, série détectable	124	Conjunto dosificador de salsas y recipiente inox Container and pump-dispenser set for sauce Ensemble de distributeur-doseur de sauces et récipient inoxydable	147
Cuchillos contrapesados Counter-balanced knives Couteaux contrebalancés	126	Tapa dosificadora de salsas con cubo Lid and pump-dispenser for sauce with bucket Couvercle doseur de sauce avec seau	148
Afilador detectosteel DetectoSteel knife-sharpener Aiguiser detectoSteel	131	Balanza mecánica de cocina Kitchen scales Balance mécanique de cuisine	148
Portacuchillos mural imantado de acero inoxidable Magnetic knife-holder in stainless steel Porte-couteaux magnétique en acier inoxidable	135	Balanza de cocina ultra-fina Kitchen scale slim design Balance de cuisine ultra-fine	149
Espátulas Spațula Spatules	137	Paleta oval en acero inox Oval serving spațula in stainless steel Pelle ovale en acier inox	152
Cuchara de cocina Spoon Cuillère	137	Paleta oval en acero inox perforada Oval perforated serving spatula in stainless steel Pelle ovale perforé en acier inox	152
Escurreidor de ollas regulable Multi-colander Passoire multiple	139	Paleta redonda aluminio Rounded tray baking peel in aluminium Pelle ronde en aluminium pour four	152
Volteadora de tortilla inox Stainless steel omelette turn over lid Couvercle retourne-omelette inox	139	Bases inoxidable para transporte de pizzas Stainless pizza pans Base inox pour transport de pizzas	153
Librador Scoop Cornet	139	Máquina para hacer churros y pastas Churros and cookies machine Appareil à churros et pâtisserie	156
Moldes cuadrados Square pastry mould Cercle carre pour pâtisserie	141	Cuencos Bowls Bols	158
Enrollador de maki super-higiénico Sushi rolling mat, ultra-hygienic Enrouleur de maki super-hygiénique	142	Plato cuatro salsas Plat a frites 4 sauces French fries dish 4 sauces	160
Molinillo de hierbas Herb mill Moulin à herbes	143	Salvamantel extensible Extending tablemat Dessous de plat extensible	165
Rallador de queso Cheese grater Râpe à fromage	143	Sacacorchos eléctrico Electric corkscrew Tire-bouchon électrique	167
Rallador inox Stainless steel grater Râpes inox	144	Tapón inox Stainless steel stopper Bouchon inox	167
Molinillo juliana Julienne mill Moulin julienne	144	Escanciador de vino Wine pourer Verseur	169
Pasapuré profesional Professional food mill Presse-purée professionnel	144		





Cuchillería profesional para Carniceros

Professional cutlery for Butchers
Coutellerie professionnelle pour Bouchers

Cuchilla de golpe

Blow knife
Couperet à frapper

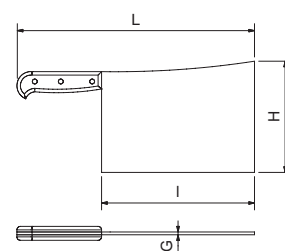

L	I	H	G	Gr	Barcode	€
360	230	165	3,37	1.175	442002	88,60
380	255	185	3,37	1.350	442004	103,30
390	270	215	4,00	1.795	442006	124,60

Cuchilla de golpe

Blow knife
Couperet à frapper

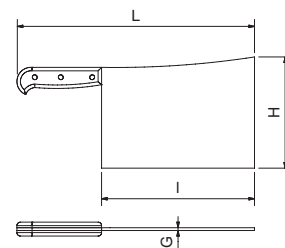

L	I	H	G	Gr	Barcode	€
280	165	120	4,0	1.030	442008	95,60
305	195	160	4,5	1.200	442010	125,82
330	220	170	4,5	1.485	442012	140,90
350	240	170	4,5	1.665	442014	177,50
360	245	190	4,5	1.850	442016	191,10

Cuchilla de golpe

Blow knife
Couperet à frapper

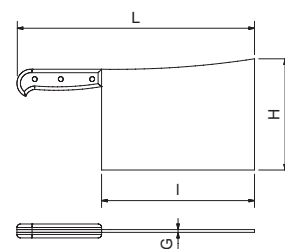

L	I	H	G	Gr	Barcode	€
330	210	180	3,5	1.045	442018	73,70
340	215	190	3,5	1.180	442020	79,25
345	220	200	3,5	1.250	442022	86,90
355	225	210	3,5	1.355	442024	92,90
370	240	220	4,0	1.570	442026	102,30
380	250	230	3,5	1.685	442028	109,90

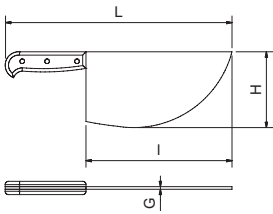

L	I	H	G	Gr	Barcode	€
390	290	170	1,4	545	442202	51,80
410	300	180	1,4	550	442204	54,60
420	310	185	1,4	610	442206	57,30

Filetero
Filet knife
Couperet-steak

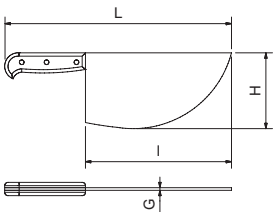

L	I	H	G	Gr	Barcode	€
365	240	115	1,3	420	442208	45,80
375	250	125	1,3	420	442210	49,70
390	260	135	1,3	430	442212	53,30
400	270	140	1,3	440	442214	57,00

Filetero
Filet knife
Couperet-steak

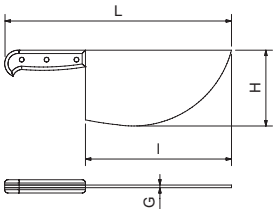

L	I	H	G	Gr	Barcode	€
370	260	160	2,5	760	442402	64,90
380	270	165	2,5	820	442404	69,90
400	280	170	2,5	1.015	442406	73,80

Chuletero
Chop knife
Couperet cotelettes

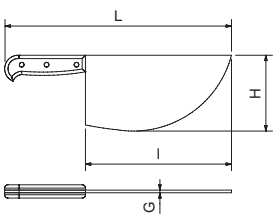

L	I	H	G	Gr	Barcode	€
365	240	115	2,5	610	442408	50,20
380	260	125	2,5	630	442410	54,20
365	250	130	2,5	705	442412	58,00
370	260	140	2,5	720	442414	62,00

Chuletero
Chop knife
Couperet cotelettes



Esquinar

Cornering knife
Couteau pour coins

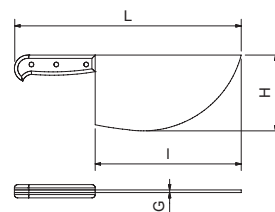

L	I	H	G	Gr	Barcode	€
365	235	110	3,2	845	442602	65,50
365	255	115	3,0	890	442604	76,50
365	265	125	3,0	920	442606	83,00
365	275	135	3,0	990	442608	88,70

Esquinar curvo

Curved cornering knife
Couteau pour coins courbé

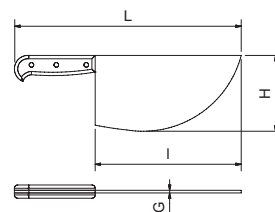

L	I	H	G	Gr	Barcode	€
335	210	110	3,0	745	442802	55,80
345	220	120	3,5	795	442804	62,50
360	230	125	3,5	885	442806	68,90
380	250	140	3,5	1.035	442808	75,30
400	270	150	3,5	1.110	442810	81,60
405	280	160	3,5	1.270	442812	87,70

Deshuesar Carne

Boning meat knife
Désosseur

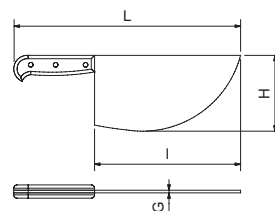

L	I	H	G	Gr	Barcode	€
300	190	115	2,38	520	443402	45,40
310	195	115	2,50	580	443404	51,30
320	200	120	2,70	635	443406	53,30
330	215	130	2,70	675	443408	57,30
345	235	135	2,70	715	443410	60,00

Desollar vaca

Cow skinning knife
Ecorcheur boeuf

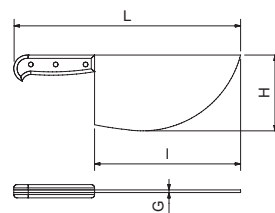

L	I	H	G	Gr	Barcode	€
275	195	90	1,5	235	443602	19,90
285	210	90	1,5	250	443604	21,40
305	220	105	1,5	260	443606	23,20

Desollar
Skinning knife
Ecorcheur

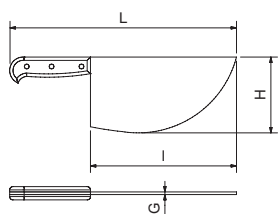

L	I	H	G	Gr	Barcode	€
280	170	55	2	175	443802	18,00
300	185	65	2	200	443804	21,10
320	200	75	2	260	443806	24,10
340	210	75	3	255	443808	27,00

Desollar
Narrow slitting knife
Egorgeur etroit

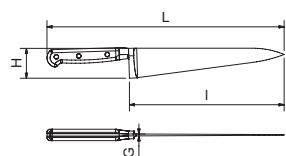

L	I	H	G	Gr	Barcode	€
310	175	40	2,0	120	443202	13,40
330	195	40	2,0	130	443204	14,60
350	205	50	2,5	175	443206	16,40

Desollar
Wide slitting knife
Egorgeur large

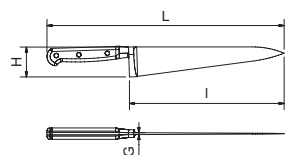

L	I	H	G	Gr	Barcode	€
250	125	24	2,24	95	443002	16,50
275	150	30	2,80	115	443004	18,70
310	175	35	2,50	135	443006	19,70

Desollar
Wide slitting knife
Egorgeur large

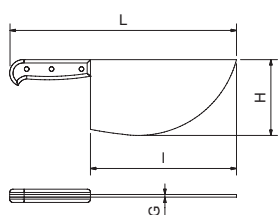

L	I	H	G	Gr	Barcode	€
290	165	65	2	175	443810	16,70
305	185	65	2	205	443812	18,50
315	195	70	2	200	443814	20,50

Pelar patas

Leg peeling knife
Couperet d'office

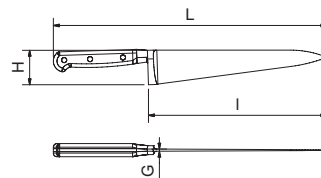

L	I	H	G	Gr	Barcode	€
210	125	55	1,7	145	444202	13,00

Pollero

Chicken knife
Couteau à poulets

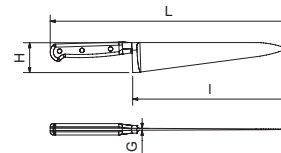

L	I	H	G	Gr	Barcode	€
440	315	90	3,3	745	447002	64,20
465	340	90	3,3	805	447004	70,00
475	350	105	3,5	955	447006	77,00

Francés todos usos

Multipurpose french knife
Français tous usages

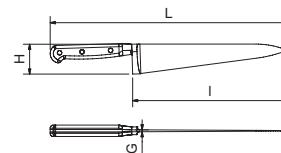

		Uso general General use Usage generale	Aves Chickens Volailles	Pescados Fish Poissons	Frutas y verduras Fruits & Vegetables Fruits et légumes	Carnes Meat Viandes				
L	I	H	G	Gr	€	Barcode	Barcode	Barcode	Barcode	Barcode
310	175	35	2,6	135	13,30	444002	444074	444020	444056	444038
335	205	35	2,6	160	14,60	444004	444076	444022	444058	444040
355	220	40	2,6	190	16,70	444006	444078	444024	444060	444042
380	250	50	2,6	210	18,50	444008	444080	444026	444062	444044
445	305	50	2,6	275	21,90	444010	444082	444028	444064	444046
485	350	55	2,6	330	29,70	444012	444084	444030	444066	444048

Cuchillo francés inyectado Adherent+

French knife with injected handle Adherent+
Couteau français injecté Adherent+



El material plástico empleado en el mango garantiza una máxima adherencia.

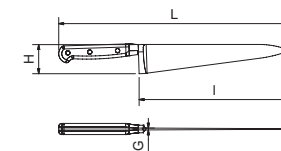

The plastic material used in the handle guarantees the maximal adherence

Le matériel en plastique utilisé dans la poignée garantit une adhérence maximale.

L	I	H	G	Gr	Barcode	€
330	190	48	3	160	444090	17,00

Puntilla
Dagger
Poignard

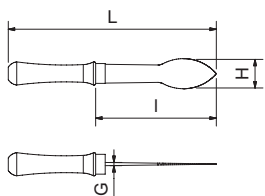

L	I	H	G	Gr	Barcode	€
260	140	33	4,5	185	444402	46,90

Serrucho acero inoxidable
Stainless steel saw
Scie en acier inoxydable

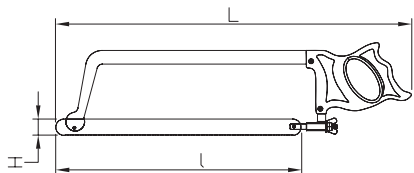

L	I	H	Gr	Barcode	€
565	400	165-20	835	447602	44,00
625	450	165-20	900	447604	45,00
725	550	165-20	1.050	447612	48,00

Repuestos para serruchos
Spare part for saw
Pièces de rechange pour scie à main



←	Gr	Barcode	€
420	35	447606	6,00
470	40	447608	7,00
570	50	447610	9,50

Hoja de repuesto inox.
Spare inox blade
Lame inox de rechange



Mango de repuesto para serrucho
Spare handle for saw
Manche de rechange pour scie à main

210 200 447630 **13,50**



Tensor inox de repuesto
Spare inox strut
Tendeur inox de rechange

50 25 447620 **10,50**

Aplasta hamburguesas circular
Rounded burger press
Press à hamburger ronde

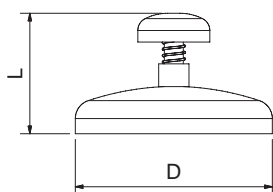

L	D	Gr	Barcode	€
70	104	250	041880	60,00

Aplasta hamburguesas de molde ovalado

Oval mold burger press
Press à hamburger moule ovale

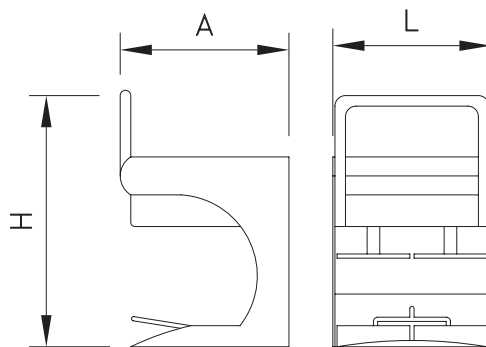

	L	A	H	Kg	Barcode	€
●●	210	250	260	3,40	441850	290,00
●●●●	410	250	260	14,00	441852	353,00

Aplasta hamburguesas de molde redondo

Round mold burger press
Press à hamburger moule rond

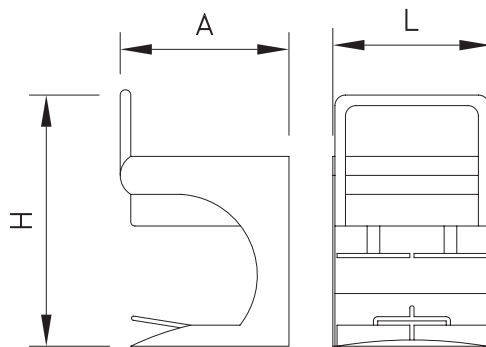

	L	A	H	Ø	Kg	Barcode	€
●●	210	250	260	65	2,00	441846	497,00
●●●●	410	250	260	65	3,00	441848	620,00
●●	210	250	260	100	2,90	441854	299,00
●●	410	250	260	130	6,00	441856	381,00

Repuestos para aplasta hamburguesas

Spare part for burger press
Pièces de rechange pour press à hamburger



Muelle elevación de palanca
Spare inox blade
Lame inox de rechange



9,00 441860 11,00



Muelle izquierdo
Left spring
Ressort gauche

13,00 441862 11,00



Muelle derecho
Right spring
Ressort droit

13,00 441864 11,00



Cuchillería profesional para charcuteros

Professional cutlery for pork butchers
Coutellerie professionnelle pour charcutiers

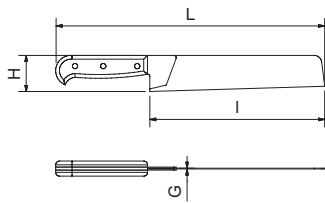

L	I	H	G	Gr	Barcode	€
325	205	40	2,0	220	444802	24,30
355	230	45	2,0	275	444804	32,00
375	250	50	2,0	310	444806	33,00
425	300	60	2,5	405	444808	43,00
450	330	65	2,5	410	444810	47,00
475	350	65	2,5	475	444812	50,30

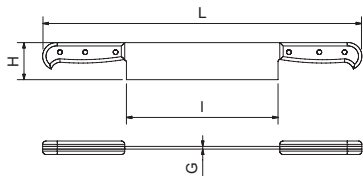

L	I	H	G	Gr	Barcode	€
525	265	55	2,6	505	445002	52,00
570	305	60	2,7	560	445004	60,70
625	365	70	2,8	645	445006	73,40

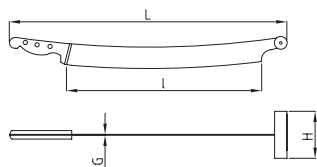

L	I	H	G	Gr	Barcode	€
635	445	50	2,6	535	448202	57,40

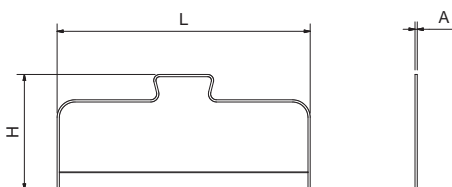

L	A	H	Gr	Barcode	€
220	10	280	106	448210	6,00

Fiambre

Cold meat knife
Charcuterie



Fiambre dos mangos

Two handle cold meat knife
Charcuterie deux manches



Queso

Cheese knife
Couteau à fromage



Lira para cortar queso

Cheese slicer
Lyre pour couper le fromage





Mundo del jamón
World of ham
Monde du jambon

Les presentamos el nuevo sistema RT de sujeción, con un solo punto de apoyo, diseñado para la presentación, corte y almacenamiento del jamón.

RT clamping system, with a single supporting point, designed for presentation, cutting and storage of ham.

Système de fixation RT, avec un seul point d'appui, conçu pour la présentation, la coupe et le stockage du jambon.



With our innovative RT support system you can move the ham from the display bar to the ham holder instantly.

The ham is easily exchangeable. The built-in RT coupling tool is designed to instantaneously place the ham in the ham holder.

Avec notre nouveau système de support RT, vous pouvez déplacer le jambon de la barre d'exposition au support de jambon en un instant.

Facile échange de jambon à couper. L'outil de couplage RT intégré est conçu pour placer instantanément le jambon dans le porte-jambon.

Con nuestros novedoso sistema de soporte RT podrá trasladar el jamón de la barra expositora al jamonero en un instante.

Fácil intercambio del jamón a cortar. El útil de acoplamiento RT que incorpora está diseñado para colocar instantáneamente el jamón en el jamonero.





Profesional, este sistema le ayudará a exponer mejor el jamón, colocándolo en la posición más adecuada en cada momento, favoreciendo la facilidad y efectividad del corte.

Professional, this system will help you to display the ham better. In addition, you will be able to place it in the most appropriate position at each moment to cut it in an easy and effective way.

Professionnel, ce système vous aidera à mieux exposer le jambon, en le plaçant dans la position la plus appropriée à chaque moment, en favorisant la facilité et l'efficacité de la coupe.

Este novedoso sistema permite:
Rotación 360° en dos dimensiones (Modelos RT-2D)
Rotación 360° en tres dimensiones (Modelo RT-3D)

This innovative system allows:
360° rotation in two dimensions (Models RT-2D)
360° rotation in three dimensions (Model RT-3D).

Ce système innovant permet:
Rotation à 360° en deux dimensions (Modèles RT-2D)
Rotation à 360° en trois dimensions (Modèle RT-3D)



Higiénico, al tener un solo punto de apoyo y quedar el jamón suspendido, las labores de limpieza se facilitan al máximo.

The ham is hold with one single supporting point, which results in an easy cleaning and better hygiene.

Hygiénique, n'ayant qu'un seul point d'appui et laissant le jambon suspendu, les tâches de nettoyage sont facilitées au maximum.



Con nuestros útiles de acoplamiento RT puede tener varios jamones expuestos y preparados para cortar en cualquier momento.

With our RT coupling tools you can have several hams displayed and ready to cut at any time.

Avec nos outils de couplage RT, vous pouvez avoir plusieurs jambons exposés et prêts à couper à tout moment.



Jamonero giratorio basculante RT-3D

Tilting rotating ham holder RT-3D
 Porte-jambon giratoire basculant RT-3D



Novedad
 ew
 ouveau

Se puede atornillar o soldar a cualquier superficie.

To be screwed or welded on any surface.

Peut se visser ou souder à n'importe quelle surface.

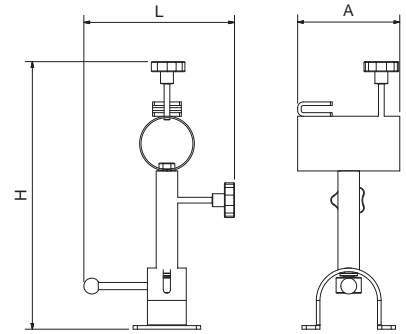

L	A	H	Kg	Barcode	€
210	140	370	1,8	041806	185,00

Jamonero giratorio RT-2D

Rotating ham holder RT-2D
 Porte-jambon giratoire RT-2D



Novedad
 ew
 ouveau

Se puede atornillar o soldar a cualquier superficie.

To be screwed or welded on any surface.

Peut se visser ou souder à n'importe quelle surface.

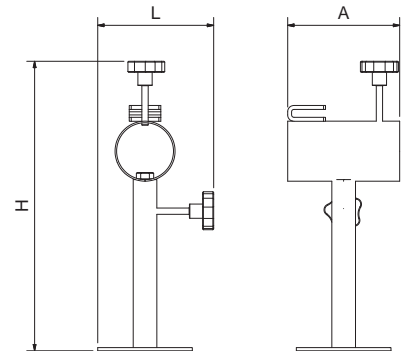

L	A	H	Kg	Barcode	€
150	140	370	1,4	041808	125,00

Jamonero giratorio mural RT-2D

Wall-mounted rotating ham holder RT-2D
 Porte-jambon giratoire mural RT-2D



Novedad
 ew
 ouveau

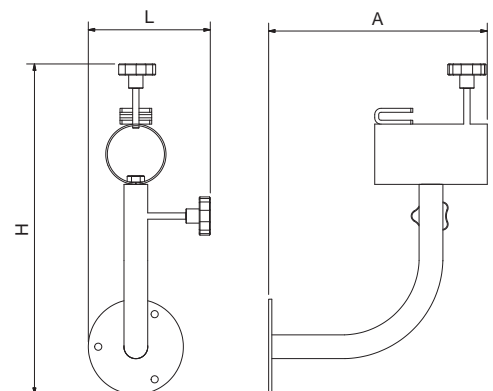
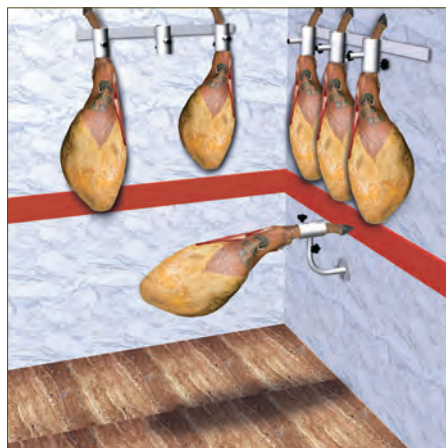

L	A	H	Kg	Barcode	€
155	275	415	1,8	041810	130,00

Soporte jamón RT
Ham holder RT
Support jambon RT

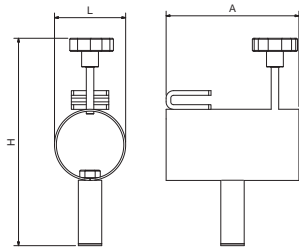

L	A	H	Gr	Barcode	€
75	140	220	800	041812	65,00

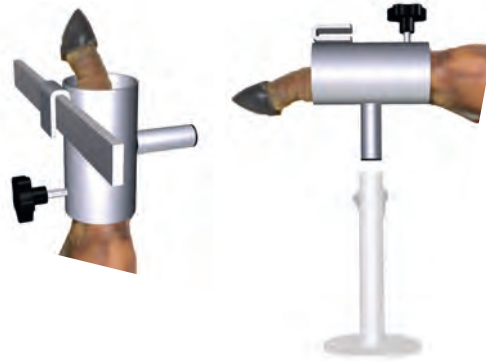

Novedad
ew
ouveau



Útil para sujeción de jamones
Ham holder tool
Outil pour porter jambons

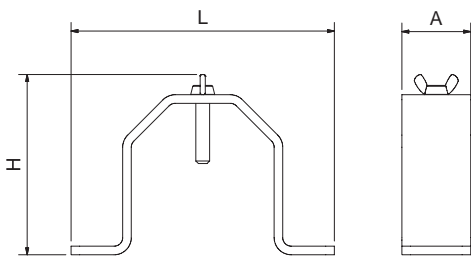

L	A	H	Gr	Barcode	€
153	40	105	400	024250	110,00



Portajamones
Ham support
Support jambons



Características:

Fabricado en una sola pieza, totalmente en acero inoxidable.
Su diseño consigue que cualquier jamón se acople con facilidad quedando firmemente sujeto.
Fácil limpieza. Al estar fabricado en acero inoxidable se puede introducir en máquinas de lavado y esterilización.
Tacos antideslizantes.

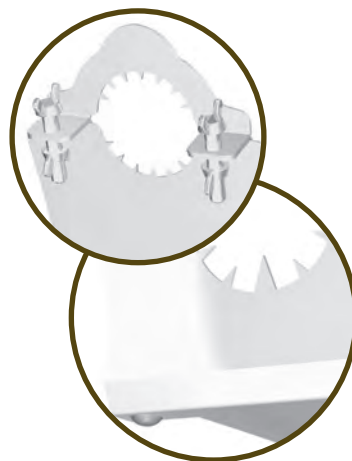

Characteristics:

One piece construction in stainless steel.
Its design allows an easy and firm fixing of any piece of ham.
Easy to clean, as it is made in stainless steel it can be washed in any washing or sterilizing device.
Anti-sliding plugs.

Caractéristiques:

Construit d'une seule pièce en acier inoxydable.
Son design permet accoupler facilement et solidement quelque jambon.
Facile à nettoyer puisque c'est construit en acier inoxydable et il est possible de l'introduire dans quelque appareil à laver ou à désinfecter.
Tampons anti-glissants.

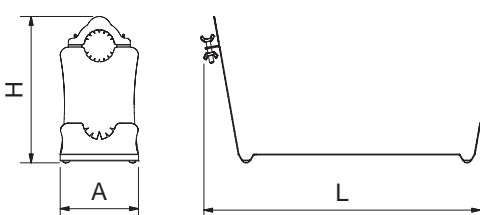

L	A	H	Kg	Barcode	€
510	270	144	2,7	041802	52,00

Portalacones

Shoulder-ham holder
Porte Jambon de Pays



Caractéristiques:

Son design permet d'exposer le jambon de pays et d'être manipulé facilement.
Facile à nettoyer.
étiquetage facil des prix.
Dimensions calculées pour occuper un espace minimum sur le comptoir.
Taquets anti dérapants qui fixent le support.
Construit en acier inoxydable.

Características:

Diseñado para exponer el género y ser manipulado fácilmente.
Facilidad de limpieza.
Facilidad de colocación del cartel indicador precios.
Dimensiones calculadas para ocupar el mínimo espacio posible en el mostrador.
Tacos de goma para evitar deslizamientos.
Construido en acero inoxidable.



Characteristics:

Designed for displaying and handling easily the product.
Easy to clean.
Easy to install a price display holder.
Dimensions optimized to occupy the minimum space on the counter.
Rubber plugs to avoid slidings.
Construction in stainless steel.

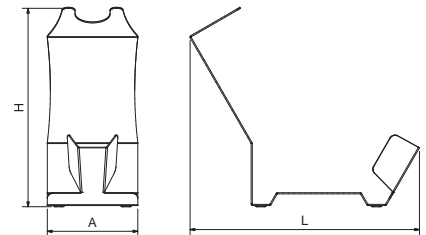

L	A	H	Kg	Barcode	€
393	155	340	2,2	041804	55,00



074488 58

Kit para colgar utensilios
Tool-holder kit
Kit pour suspendre outils



485002 467

Ruedas acopladas
Wheels
Rouelles



074490 150

Kits de portarrollos de papel o film serie Eco
Eco serie paper or film roll holder kit
Kit de porte-rouleaux du papier ou film serie Eco

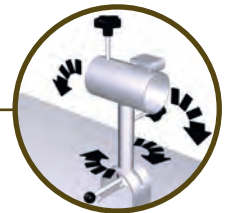

085480 464

Cajón o tolva acoplado
Drawer or hopper coupled
Tiroir ou trémie accouplé

Mesa jamonera RT-2D
 Ham table RT-2D
 Table porte-jambon RT-2D

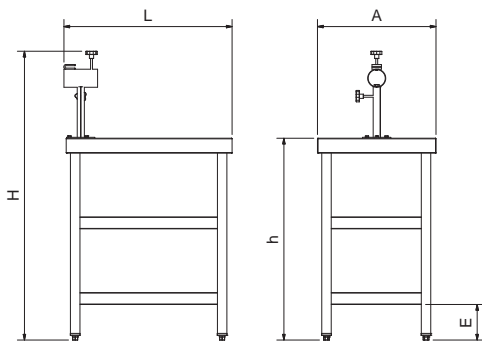

L	A	H	h	E	Kg	Barcode	€
710	500	1.220	850	150	20,00	074486	532,00

Mesa jamonera RT-3D
 Ham table RT-3D
 Table porte-jambon RT-3D

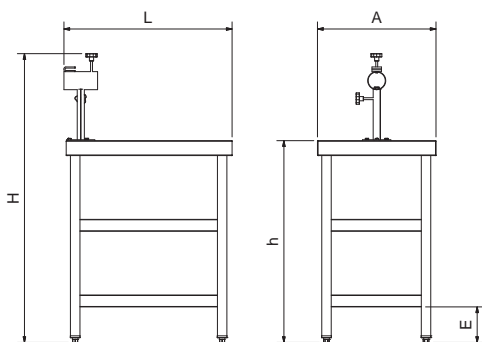

L	A	H	h	E	Kg	Barcode	€
710	500	1.220	850	150	20,00	074487	599,00

Punto de venta portátil de jamones

Mobile sale point of hams

Point de vente de jambon portable



Características de fabricación:

- Ruedas de $\varnothing 75$ mm.
- 2 cajones pequeños
- 1 cajón grande
- 2 puertas abatibles
- 1 contenedor verde 486026
- 1 Portacuchillos con envoltente
- 1 Dispensador de 1 caja de guantes
- 1 Dispensador de papel y bolsas triple
- 1 Kit portarrollos
- 1 Pletina de 1500 mm. con 12 ganchos para jamones
- 1 base de jamonero giratorio basculante RT-3D
- 3 jamoneros giratorios RT-2D
- 1 fibra negra de 500x465x20 mm. con agujero de desbarasado
- Espacio disponible para báscula

Manufacturing characteristics:

- Wheels $\varnothing 75$ mm.
- 2 small drawers
- 1 large drawer
- 2 folding doors
- 1 green container 486026
- 1 Knife holder with casing
- 1 Dispenser for 1 glove box
- 1 Triple dispenser for paper and bags
- 1 Roll holder kit
- 1 1.500 mm bar with 12 hooks for hams
- 1 foot of tilting rotating ham holder RT-3D
- 3 rotary ham holders RT-2D
- 1 black board of 500x465x20 mm with hole for disposals
- Enough room for a scale

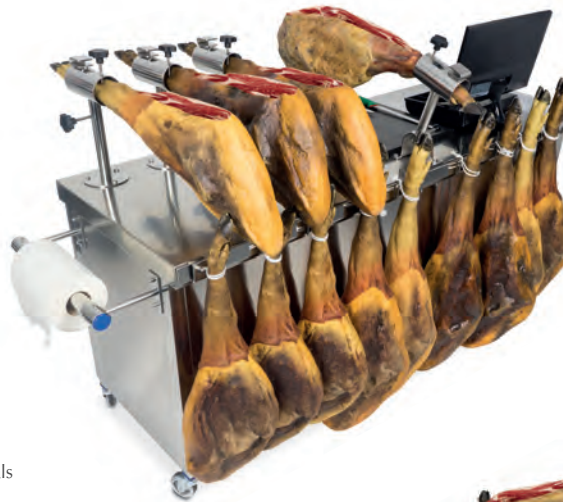

Caractéristiques de fabrication:

- Roues $\varnothing 75$ mm.
- 2 petits tiroirs
- 1 grand tiroir
- 2 portes ouvrantes
- 1 container vert 486026
- 1 Porte-couteau avec enveloppant
- 1 Distributeur de 1 boîte à gants
- 1 Distributeur triple papier et sac
- 1 Kit de support de rouleau
- 1 Plaque de 1500 mm. avec 12 crochets pour les jambons
- 1 base de porte-jambon rotatif basculant RT-3D
- 3 porte-jambons rotatifs RT-2D
- 1 plaque noire de 500x465x20 mm. avec trou pour déchets
- Espace disponible pour la balance.

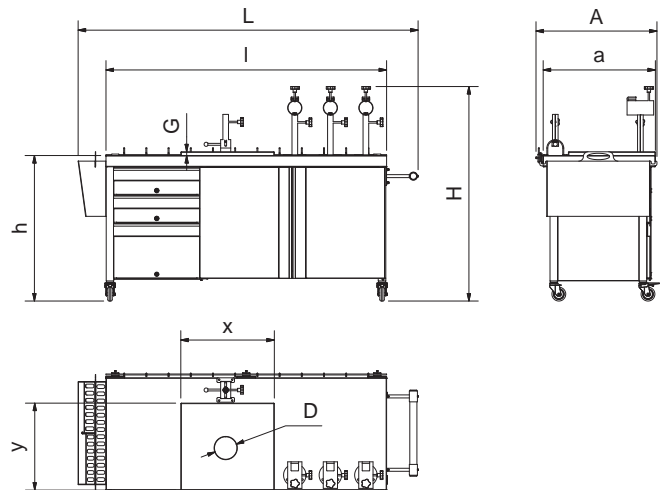

L	I	A	a	H	h	X	Y	G	D	Kg	€
1.815	1.500	645	600	1150	780	500	465	20	120	98,00	075230 2.970,00

Estante abatible de fibra para punto de venta portátil de jamones

Polyethylene hinged shelf for mobile sale point of hams
Étagère ouvrante en fibre pour point de vente de jambon portable

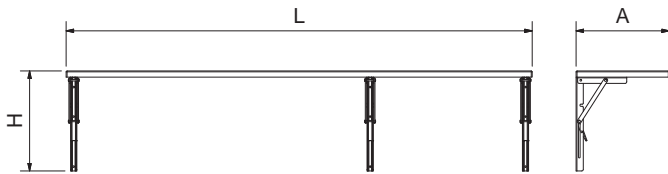

L	A	H	Kg	Barcode	€
1.500	300	325	10,3	075232	274,00

Plafones para exposición de embutidos

Sausage display boards
Panels d'exposition pour charcuterie



Gancho opcional. 021602
Optional hook.
Crochet optionnel.



44

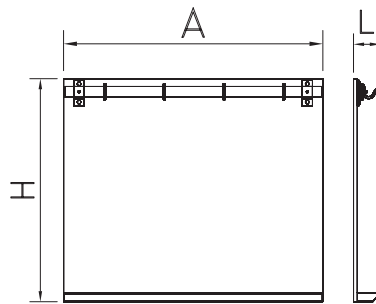

A	L	H	Nº Ganchos Hooks Crochets	Kg	Barcode	€
800	110	865	3	10	024202	390,00
1.000	110	865	4	11	024204	436,00
1.500	110	865	5	15	024206	560,00

Set para corte de jamón

Ham slicing set
Set pour couper le jambon

Completo set de herramientas para el corte de jamón que incluye:

Bolsa de transporte con alojamientos para cada cuchillo, además de solapas para tarjetas de visita, bolígrafos, etc. Chaira 447202.

Pinza jamonera.

Cuchillo jamonero (largo de hoja 290 mm).

Cuchillo deshuesador de jamón.

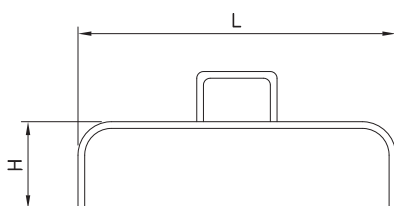

L	H	Gr	Barcode	€
475	135	740	448062	61,00

Complete set of tools for slicing ham consisting of:

Carrying bag with provided with lodgings for each knife along with slots for business cards, pens, etc. Sharpener (ref. 447202).

Ham tweezers.

Ham knife (length of blade 290 mm).

Ham boning knife.

Ensemble complet d'outils pour la découpe du jambon qui inclus:

Sac de transport avec logement pour chaque couteau, ainsi que des volets pour les cartes de visite, stylos, etc.

Fusil à affûter 447202.

Pince à jambon.

Couteau à trancher (longueur de la lame 290 mm).

Couteau à jambon de désossage.

Jamón serrano virola

Ferrule knife for parma ham
Couteau à jambon de montagne à virole

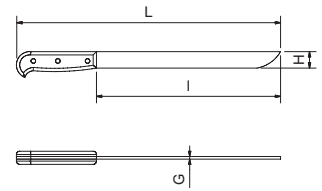

L	I	H	G	Gr	Barcode	€
405	260	22	2,00	135	445402	33,40
430	285	22	1,75	140	445404	35,00
460	310	22	2,16	150	445406	36,40
480	340	22	2,20	155	445408	38,90

Jamón serrano

Knife for parma ham
Couteau à jambon de montagne

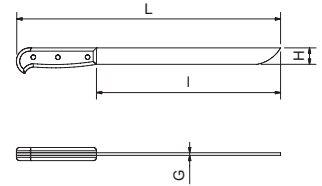

L	I	H	G	Gr	Barcode	€
390	250	20	1,5	105	445202	13,10
440	300	20	1,6	120	445204	14,10

Jamón serrano alveolado punta redonda

Ham knife fluted blade, round tip
Couteau alvéolé pour jambon de pays avec pointe ronde

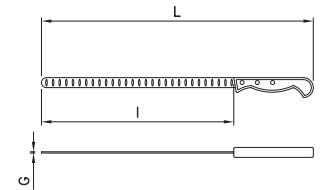

L	I	G	Gr	Barcode	€
410	290	1,5	115	445206	24,00

Jamonero curvo

Curved ham knife
Couteau à jambon courbe

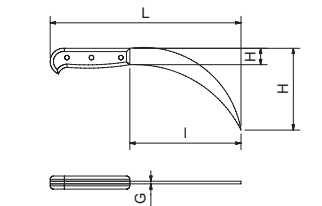

L	I	H	G	Gr	Barcode	€
280	160	30-130	1,9	170	445602	32,20

Gubia deshuesar jamón

Ham boning gouge
Gouge à désosser jambon



L	I	H	Gr	Barcode	€
395	245	40	370	444602	64,60

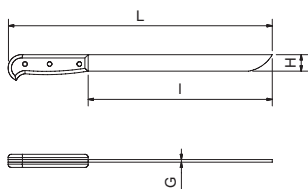

Deshuesar jamón

Ham boning knife
Désosseur jambon



L	I	H	G	Gr	Barcode	€
340	205	22	3,2	140	445802	16,40
395	260	25	3,0	160	445804	19,60
435	300	25	3,0	165	445806	22,70

Deshuesar jamón

Ham boning knife
Désosseur jambon

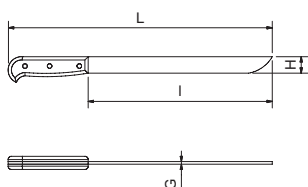

		Usos general General use Usage generale	Aves Chickens Volailles	Pescados Fish Poissons	Frutas y verduras Fruits & Vegetables Fruits et légumes	Carnes Meat Viandes
L	I	H	G	Gr	€	Barcode
270	130	20	2,43	115	11,50	445850
290	150	23	2,45	120	12,50	445852

Pinza para servir jamón

Ham tong
Pincas pour servir le jambon

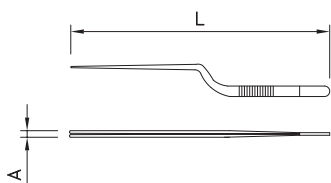

L	A	Gr	Barcode	€
200	5	25	440068	8,10

Pinza para servir jamón

Ham tong
Pincas pour servir le jambon

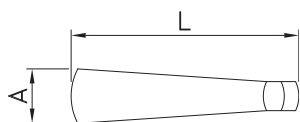

L	A	Gr	Barcode	€
120	100	15	440070	9,80

Pinza para embutidos

Meat tongs
Pince saucisse

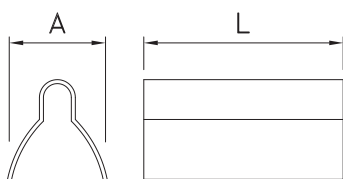

L	A	Gr	Barcode	€
100	50	120	440030	4,50



Cuchillería profesional para pescaderos
Professional cutlery for fishmongers
Coutellerie professionnelle pour poissonniers

Pescadero

Fish knife
Couteau à poisson

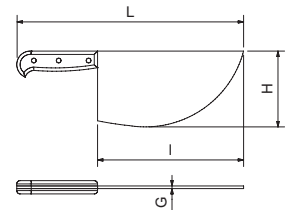

L	I	H	G	Gr	Barcode	€
440	320	180	1,6	670	446002	70,50
460	340	190	1,4	735	446004	74,80
475	355	200	1,5	790	446006	83,00
495	375	215	1,6	850	446008	107,20

Pescadero punta aguda

Sharp edged fish knife
Couteau à poisson à pointe fine

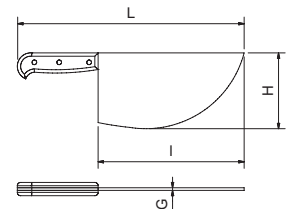

L	I	H	G	Gr	Barcode	€
450	320	110	1,76	555	446202	73,50
470	340	120	1,72	650	446204	77,50
490	360	135	1,90	725	446206	82,20

Pescadero punta redonda

Round edged fish knife
Couteau à poisson à pointe ronde

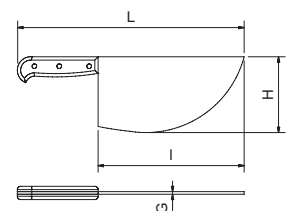

L	I	H	G	Gr	Barcode	€
455	325	100	1,8	605	446402	81,80
465	335	124	1,9	705	446404	86,20
485	355	120	1,5	590	446406	90,50

Pescadero
Fish knife
Couteau à poisson

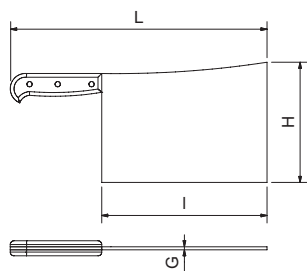

L	I	H	G	Gr	Barcode	€
380	270	100	1,8	490	446010	58,60
420	290	105	1,4	480	446012	62,20
415	300	120	1,5	520	446014	65,80

Escamador
Scale removers
Ecailleurs

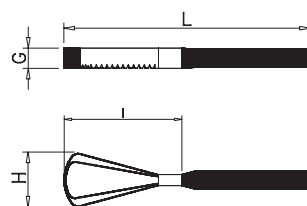

L	I	H	G	Gr	Barcode	€
270	95	60	20	215	040202	20,00

Escamador EC
Scale removers EC
Ecailleurs EC

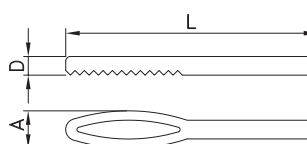

L	A	D	Gr	Barcode	€
265	40	22	180	440052	7,00

Bacaladera
Cod knife
Couteau à morue

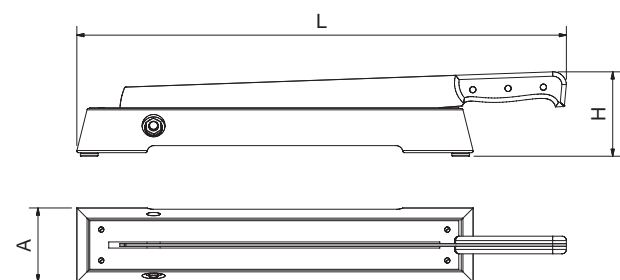

L	A	H	Gr	Barcode	€
550	85	95	2.185	446602	137,50



Cuchillería profesional para cocineros

Professional cutlery for cooks
Coutellerie professionnelle pour chefs



Características de fabricación de todos nuestros cuchillos:

Todos nuestros cuchillos llevan mango inyectado, de fibra o de acero inoxidable. Sus hojas están fabricadas en AISI 420 Molibdeno-Vanadio.

Manufacturing characteristics of all our knives:

All our knives have injected, fibre or stainless steel handles. The blades are made of AISI 420 Molybdenum-Vanadium.

Caractéristiques de fabrication de tous nos couteaux:

Tous nos couteaux ont le manche injecté, en fibre ou en acier inoxydable. Les lames sont fabriquées en AISI 420 Molybdène-Vanadium.

Modelo cocinero forjado

Forged cooking model
Modèle chef forgé

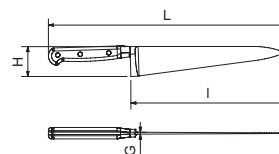

L	I	H	G	Gr	Barcode	€
200	95	20	2,00	65	440202	21,90
255	150	30	2,80	115	440204	30,90
320	200	40	2,75	190	440206	41,40
370	250	50	3,40	280	440208	50,80
430	295	55	3,50	375	440210	69,90
490	350	65	3,60	500	440212	90,70

Modelo cocina

Kitchen model
Modèle chef

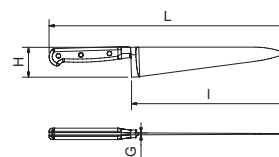

L	I	H	G	Gr	Barcode	€
325	200	45	2,77	155	440450	14,20
350	225	48	2,70	180	440452	16,30
380	250	55	2,60	205	440454	18,10

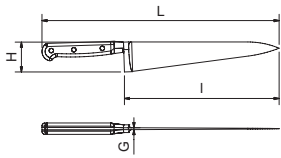

Modelo cocina
Kitchen model
Modèle chef



L	I	H	G	Gr	Barcode	€
200	105	24	1,6	50	440400	8,30
225	125	28	1,5	65	440401	9,80
265	150	33	2,0	110	440402	12,50
295	180	38	2,0	115	440404	15,00
320	200	42	2,8	180	440406	17,90
350	230	45	2,5	190	440408	21,70
375	255	50	2,5	215	440410	25,80
435	305	60	2,8	310	440412	32,50
475	345	70	2,8	390	440414	47,40

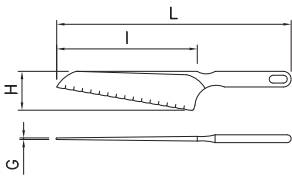

Cuchillo antioxidante para verduras
Anti-oxidation knife for vegetables
Couteau antioxydant pour légumes



L	I	H	G	Gr	Barcode	€
300	190	40	2	65	440066	2,50

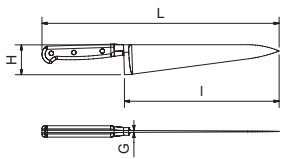

Pelador
Peeling knife
Éplucheur



L	I	H	G	Gr	Barcode	€
180	80	20	1,53	35	444204	7,10

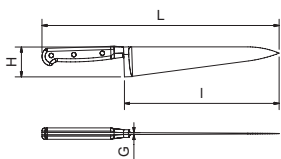

Puntilla
Dagger
Proignard



L	I	H	G	Gr	Barcode	€
205	100	21	1,8	50	444404	7,10
260	155	30	1,8	60	444406	10,10

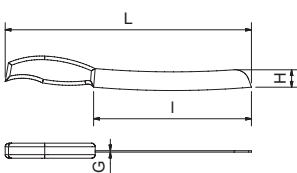

Cortar pan
Bread knife
Couteau à pain



L	I	H	G	Gr	Barcode	€
345	215	25	1,8	110	448002	13,80

Paleta plancha

Grill plate spatula
Palette grill

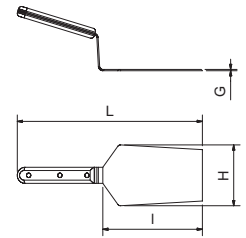

L	I	H	G	Gr	Barcode	€
290	160	95	2	320	441602	20,00

Espátula plancha

Hot plate spatula
Raclette grill

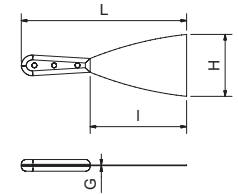

L	I	H	G	Gr	Barcode	€
250	140	80	1	165	441202	13,90
230	130	90	1	100	441204	15,30
230	130	95	1	115	441206	16,40

Espátula pastelera

Bakery spatula
Spatule à gâteau

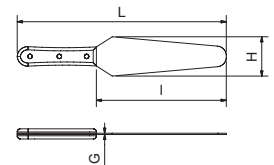

L	I	H	G	Gr	Barcode	€
215	125	26	1,0	65	441402	10,90
255	155	26	1,0	70	441404	12,10
335	205	40	1,0	170	441406	17,10
385	255	45	1,0	190	441408	22,80
440	315	45	1,5	205	441410	28,80
490	365	45	1,5	265	441412	34,10

Espátula mantequilla

Butter spatula
Spatule à beurre

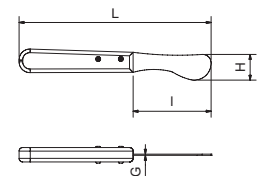

L	I	H	G	Gr	Barcode	€
160	65	23	1	35	441002	4,20

Aguja de mechar

Stuffing needle
Aiguille lardoire

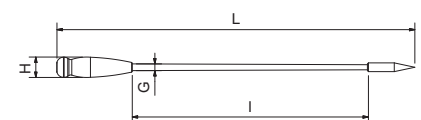

L	I	H	G	Gr	Barcode	€
500	390	28	11	210	440802	79,70

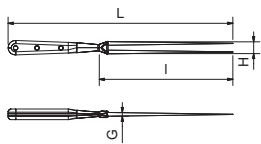

L	I	H	G	Gr	440602	€
320	180	25	5,4	150	440602	36,60

Tenedor de trinchar

Carving fork
Fourchette de chef

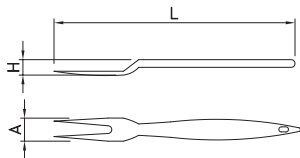

L	A	H	Gr	440040	€
320	60	40	100	440040	4,90

Tenedor trinchar EC

Carving fork EC
Fourchette de chef EC

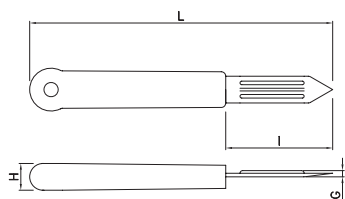

L	I	H	G	Gr	446902	€
170	65	15	3,5	26	446902	5,50

Pelador

Peeling knife
Éplucheur

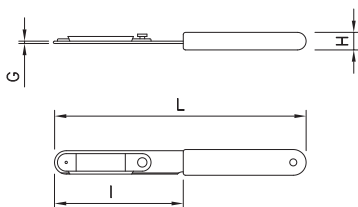

L	I	H	G	Gr	446922	€
215	107	10	3	55	446922	13,90

Pelador de espárragos

Asparagus peeling knife
Éplucheur d'asperges

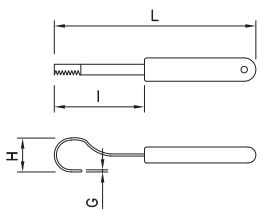

L	I	H	G	Gr	446920	€
190	84	10	2	53	446920	5,60

Rizador de mantequilla

Butter curler knife
Coquilleur à beurre

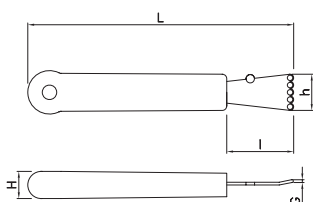

L	I	H	G	h	Gr	446904	€
145	38	15	1,5	20	29	446904	9,30

Rallador

Grater
Râpe



Acanalador

Canelle knife
Zesteur canneléur

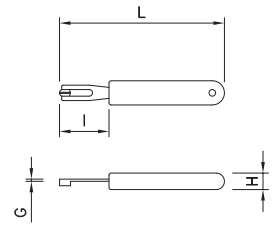

L	I	H	G	Gr	Barcode	€
150	44	10	2	41	446918	5,60

Vaciador doble

Double hollowing-out knife
Couteau à vider double

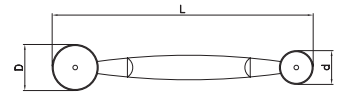

L	D	d	Gr	Barcode	€
170	30	22	53	446910	16,40

Descorazonador

Corer
Couteau carottier

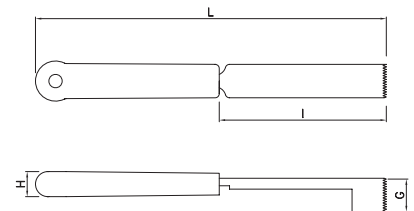

L	I	H	G	Gr	Barcode	€
210	100	15	20	40	446906	8,00

Decorador de fruta

Decorating knife for fruits
Couteau décorateur de fruit

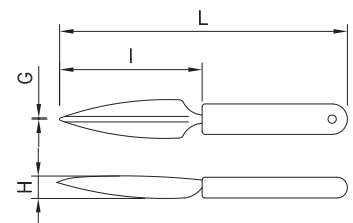

L	I	H	G	Gr	Barcode	€
210	105	15	2	54	446916	5,20

Decorador

Decorating knife
Couteau à décorer

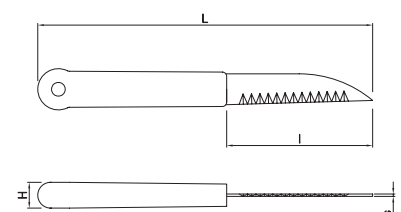

L	I	H	G	Gr	Barcode	€
190	85	17	1,5	36	446912	14,50

Set de decoración

Decoration set
Décor set

Contenido del set de decoración:

5 cuchillos talladores.
Una esfera de \varnothing 20 mm. (melón)
Un cuchillo en forma de hoz.
Una chaira de cerámica.

Decoration set content:

5 carving knives.
Melon baller
Sickle-shaped knife
Ceramic sharpener

Contenu du set:

5 couteaux à découper.
Cuillère à melon
Couteau faucille
Fusil à aiguiser en céramique



Tomate

Tomato knife
Couteau à tomate

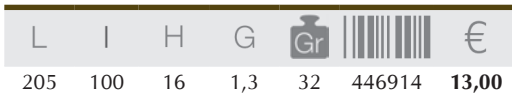
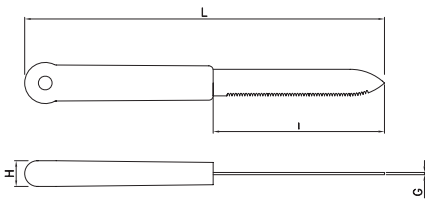

Aplastafiletos circular

Meat pounder with round handle
Aplatisseur ronde

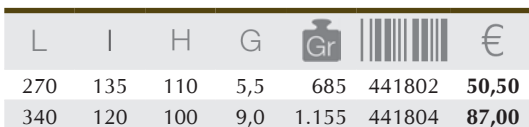
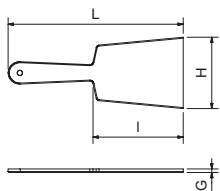
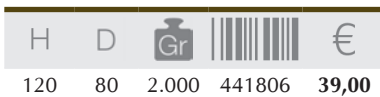
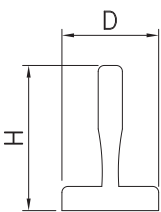

Aplastafiletos

Filet flattener
Ecrasse-steak



Recoge verduras

Vegetable plate
Plaque de légumes

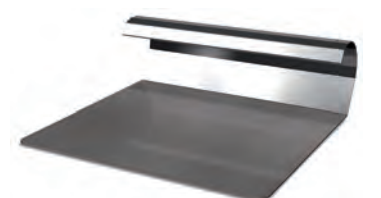
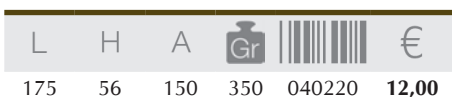
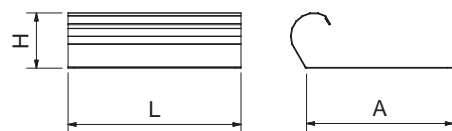

Cuchillería cerámica

Ceramic knives

Couteaux en céramique

Cocina

Kitchen chef's knife
Couteau chef

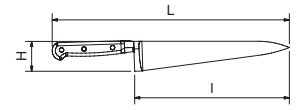

L	I	H	Gr	Barcode	€
270	150	35	107	446116	12,00
295	175	40	138	446118	16,00
320	200	43	154	446120	19,00

Panero

Bread knife
Couteau à pain

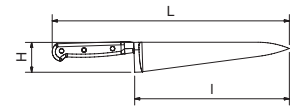

L	I	H	Gr	Barcode	€
275	155	30	104	446114	14,00

Santoku

Santoku knife
Couteau Santoku

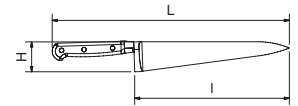

L	I	H	Gr	Barcode	€
225	123	33	169	446112	12,00

Puntilla

Dagger
Proignard

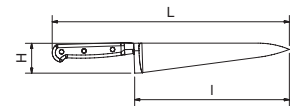

L	I	H	Gr	Barcode	€
175	75	20	39	446106	5,00
200	100	20	43	446108	6,00

Utilitario

Utility
Utilitaire

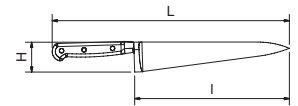

L	I	H	Gr	Barcode	€
230	125	25	58	446110	8,00

Pelador

Peeling
Éplucheur

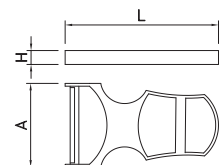

L	I	H	Gr	Barcode	€
120	50	20	75	446122	3,00

Características de fabricación:

La hoja del cuchillo está fabricada con molibdeno vanadio recubierto de una capa de titanio de color azul. El principal beneficio que aporta el titanio es que no es tóxico ni alérgico, y como es un material que no genera iones de hierro, evita que la comida pueda oxidarse. El titanio además es muy resistente a la corrosión y a la abrasión y es muy fácil de limpiar porque es extremadamente deslizante.

Mango ergonómicamente diseñado, fabricado en polipropileno resistente hasta 80°C.

Manufacturing characteristics:

The knife blade is made from molybdenum vanadium coated with a layer of blue titanium. The main advantage is that titanium is not toxic or allergic. In addition it does not produce iron ions so that it prevents food from oxidizing. Titanium is also highly resistant to corrosion and abrasion and is very easy to clean because it is extremely non-stick.

Ergonomically designed handle, made of polypropylene heat resistant up to 80°C.

Caractéristiques de fabrication:

La lame du couteau est fabriquée à partir de molybdène vanadium revêtu d'une couche de titane bleu. Le grand avantage est que le titane n'est pas toxique ou allergique. En plus, il ne produit pas d'ions de fer afin qu'il empêche l'oxydation des aliments. Le titane est également très résistant à la corrosion et à l'abrasion et est très facile à nettoyer car il est extrêmement anti-adhésive.

Poignée ergonomique, en polypropylène résistant à la chaleur jusqu'à 80°C.

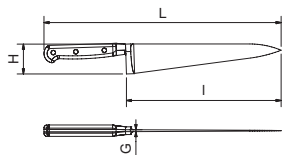

L	I	H	G	Gr	Barcode	€
215	85	25	1,0	57	446508	30,00

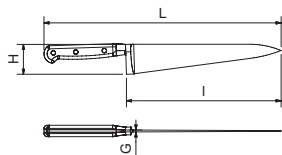

L	I	H	G	Gr	Barcode	€
230	130	40	2,0	62	446510	69,00

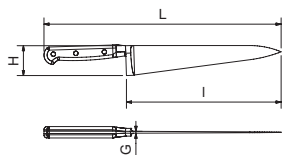

L	I	H	G	Gr	Barcode	€
290	160	45	3,0	66	446512	74,00
310	180	50	3,0	75	446514	85,00

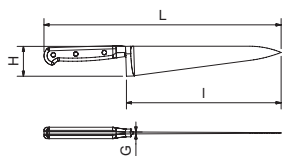

L	I	H	G	Gr	Barcode	€
350	220	35	2,5	92	446516	91,00

Pelador

Peeling knife
Éplucheur



Vegetales

Vegetable knife
Couteau à légumes



Cocinero

Chef knife
Couteau de cuisine



Sashimi

Sashimi knife
Couteau Sashimi



Cuchillería Deglon

Deglon knives
Couteaux Deglon



Características de fabricación:

Elegante, de líneas limpias y depuradas, así nace el diseño de Meeting®.

Esta versión de acero inoxidable se presenta sobre madera de roble de Borgoña.

Materiales atemporales y elegantes, Meeting® sabe mezclar estética y funcionalidad.

Manufacturing characteristics:

The «Meeting®» design is about clean, uncluttered lines coupled with high-quality materials.

Available in an all stainless steel version, as well as in a brand new presentation with a natural oak stand. Made from timeless and elegant materials, «Meeting®» has succeeded in combining beauty and practicality.

Is what gives it its unique character.

Caractéristiques de fabrication:

Des lignes nettes et épurées, voici le design Meeting®.

En version tout inox ainsi que dans une toute nouvelle présentation avec un support en chêne de Bourgogne. Matériaux intemporels et élégants, Meeting® sait mêler esthétique et fonctionnalité.



Deglon Meeting 3 piezas

Deglon Meeting knife set 3 pc

Deglon Meeting set de couteaux 3 pc



Características:

El estuche contiene: un cuchillo cocinero, un cuchillo de trinchar y una puntilla.

Portacuchillos de madera de roble de Borgoña.



Characteristics:

This boxed set comprises: one paring knife, one kitchen knife, one carving knife.

Oak support of Burgundy.

Caractéristiques:

Ce coffret comprend: un couteau d'office, un couteau de cuisine, un couteau à découper..

Support chêne de Bourgogne.

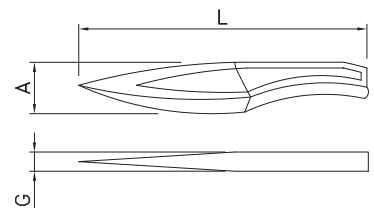

L	A	G	Gr	Barcode	€
300	75	20	500	440102	480,00

Cuchillería con revestimiento antiadherente ILAFLON RESIST™

Knives with nonstick coating ILAFLON RESIST™

Couteaux à revêtement antiadhésif ILAFLON™ RESIST™

Características de fabricación:
Sistema de revestimiento antiadherente ILAFLON RESIST™, bi-capa de alta resistencia, con refuerzo cerámico.

Estas dos capas se combinan de forma óptima para crear una película que presenta un excelente efecto antiadherente, de esta forma se consigue que el corte se desprenda fácilmente de la hoja.

- Anti-adherente
- Mayor agilidad al cortar
- Anti-corrosión
- Anti-manchas
- Mejor desinfección y limpieza

Manufacturing characteristics of knives with nonstick coating Knives with nonstick coating ILAFLON RESIST™: Nonstick coating system ILAFLON RESIST™, with high strength two-layer coating and ceramic reinforcement. These two layers are combined in an optimal way in order to create a film with an excellent nonstick effect. In this way any cut you make will be detached from the blade easily.

- Nonstick.
- Cutting agility.
- Anti-corrosion.
- Stain-resistant.
- Better sanitation.

Caractéristiques de fabrication de couteaux à revêtement antiadhésif Couteaux à revêtement antiadhésif ILAFLON™ RESIST™:

Système de revêtement antiadhésif ILAFLON RESIST™, avec haute résistance à deux couches de revêtement et renforcement de céramique. Ces deux couches sont combinées de manière optimale afin de créer un film avec un effet anti-adhésif excellent. De cette façon, toute tranche que vous faites sera détachée de la lame facilement.

- Revêtement antiadhésif.
- Agilité de coupe.
- Anti-corrosion.
- Résistant aux taches.
- Meilleur assainissement.

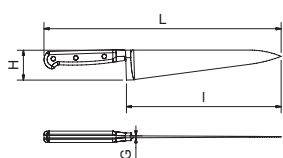

L	I	H	G	Gr	Barcode	€
210	100	21	1,5	51	446702	11,90

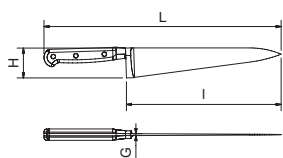

L	I	H	G	Gr	Barcode	€
320	200	49	3,0	203	446704	31,00
370	250	53	3,0	263	446706	37,00
420	300	67	3,0	441	446708	57,60

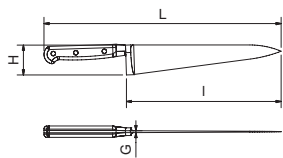

L	I	H	G	Gr	Barcode	€
330	200	29	2,0	144	446710	25,00

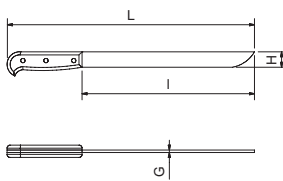

L	I	H	G	Gr	Barcode	€
450	300	11	1,8	95	446712	25,00

Puntilla

Paring knife
Couteau d'office



Cocinero

Chef knife
Couteau de cuisine



Panero

Bread knife
Couteau à pain



Jamonero

Ham knife
Couteau à jambon



Cuchillería de fabricación alemana

German manufacturing knives

Couteaux de fabrication allemande



Características de fabricación:

SEGURIDAD EN UN DISEÑO PROBADO. Hace más de 30 años, ZWILLING J.A. HENCKELS revolucionaba los estándares para los cuchillos de cocina de alta calidad al crear el mango sintético sin juntas.

- Material de mango: sintético.
- Transición sin juntas del cabezal al mango.
- Acero inoxidable y fundición especial.
- Hoja endurecida al frío con FRIODUR.
- Cuchillos SIGMAFORGE hoja forjada de una única pieza.

Manufacturing characteristics:

SAFETY IN A PROVEN DESIGN. More than 30 years ago ZWILLING J.A. HENCKELS revolutionised the standards for top-quality knives with this seamless synthetic handles.

- Handle material: synthetic.
- Seamless transition from bolster to handle.
- Stainless steel and special smelting.
- FRIODUR knife, ice-hardened.
- SIGMAFORGE knife - forged from one piece.

Caractéristiques de fabrication:

LA SÉCURITÉ D'UN MODÈLE QUI A FAIT SES PREUVES. Il y a plus de 30 ans, ZWILLING J.A. HENCKELS révolutionna les normes des couteaux de qualité optimale avec ces manches synthétique homogènes.

- Manche: synthétique.
- Transition homogène entre la mitre et le manche.
- Acier inoxydable unique, formule spéciale.
- Couteau FRIODUR en acier trempé.
- Couteau SIGMAFORGE - forgé d'une seule pièce.

Puntilla

Paring knife
Couteau d'office

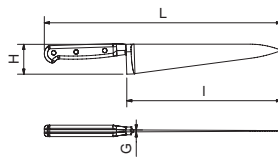

L	I	H	G	Gr	Barcode	€
205	100	20	1,0	54	447302	56,00

Universal dentado

Universal knife
Couteau universel

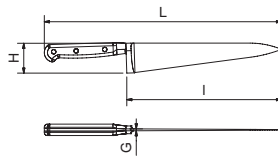

L	I	H	G	Gr	Barcode	€
230	130	20	1,0	58	447304	64,00

Filetear

Fillet knife
Filet de couteau

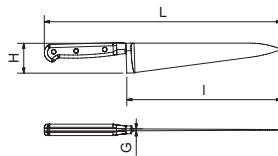

L	I	H	G	Gr	Barcode	€
290	160	29	1,0	112	447306	75,00
318	200	29	2,0	122	447308	87,00
370	260	29	2,0	144	447310	104,00

Jamonero

Ham knife
Couteau à jambon

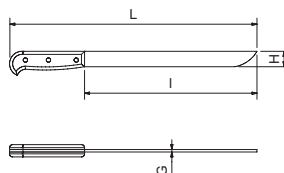

L	I	H	G	Gr	Barcode	€
431	300	17	2,0	148	447312	129,00

Cebollero

Onion knife
Couteau oignon

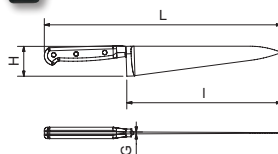

L	I	H	G	Gr	Barcode	€
329	200	41	3,0	212	447314	106,00



Características de fabricación:

Los cuchillos profesionales de Victorinox se caracterizan por sus resistentes materiales de primera calidad que se adaptan a la mano y se ajustan con precisión a cada aplicación. La dureza correcta de la hoja y el ángulo de corte controlado por láser garantizan una elevada eficiencia de corte.

Manufacturing characteristics:

The professional knives Victorinox are characterized by their durable materials of first quality. They fit the hand and conform precisely to each use. The right blade hardness and the laser-tested cutting angle guarantee high cut efficiency.

Caractéristiques de fabrication:

Les couteaux professionnels Victorinox sont caractérisés par leurs matériaux durables et de première qualité. Ils s'ajustent à la main et de s'adaptent parfaitement à chaque utilisation. La correcte dureté de lame et l'angle de coupe contrôlé par laser garantie coupe à haut rendement.

L	I	H	G	Gr	Barcode	€
442	300	21	1,8	150	445902	60,50

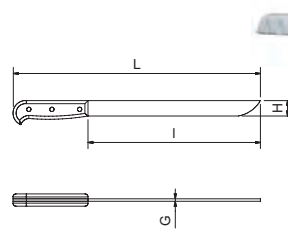

Salmón
Salmon knife
Couteau à saumon

L	I	H	G	Gr	Barcode	€
282	150	37	2,0	130	445904	34,00

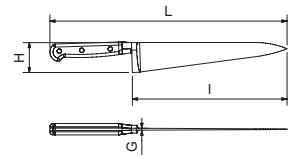

Despellejar
Skinning knife
Écorcheur

L	I	H	G	Gr	Barcode	€
282	150	22	2,5	125	445914	26,70

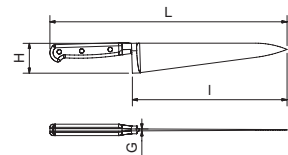

Deshuesar
Boning knife
Couteau à désosse

L	I	H	G	Gr	Barcode	€
297	160	36	2,5	125	445906	34,50
337	200	36	2,5	170	445908	43,70
397	260	51	2,5	220	445910	51,00

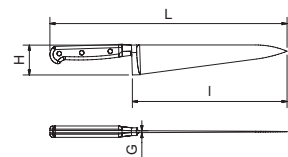

Carnicero
Butcher
Boucher

L	I	H	G	Gr	Barcode	€
340	210	20	1,5	135	445912	33,00

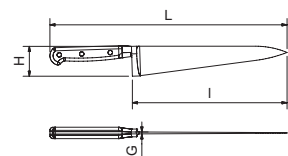

Fileteador flexible
Flexible filleting knife
Couteau à filet flexible

DetectoGrip, serie detectable

DetectoGrip, detectable series

DetectoGrip, série détectable



DetectoGrip, serie detectable

Para el procesamiento de la carne está permitido únicamente el uso de cuchillos y herramientas con mangos de plástico. Los mangos de material sintético blando albergan un riesgo de desgaste, por lo cual las partículas más finas pueden llegar a los alimentos. Estos problemas se evitan empleando cuchillos y herramientas con mangos firmes de plástico. No obstante, los daños en el cuchillo pueden provocar la contaminación de los alimentos por partículas de metal y de plástico. Al contrario que las piezas metálicas, las partículas de plásticos convencionales

no se pueden percibir con detectores y equipos de rayos X. Friedr. Dick presenta la serie de cuchillos detectables DetectoGrip y la afiladora Detecto Steel HyperDrill. Añadiendo piezas metálicas en el plástico, se pueden detectar a partir de ahora las partículas de plástico en los alimentos mediante detectores de metales y equipos de rayos X convencionales. En cooperación con nuestro fabricante de plástico, se ha desarrollado un material mediante el cual se ha mejorado aún más la capacidad de detección de esta mezcla de plástico. Esto ha sido comprobado y demostrado en pruebas internas y externas.

DetectoGrip, detectable series

When it comes to processing meat, knives and tools with plastic handles must be used exclusively. Handles made from soft plastic material hold the risk of abrasion and the finest particles may get into food. This problem can be prevented if knives and tools with hard plastic handles are utilised. Nonetheless, food can be contaminated with metal and plastic particles due to damage to the knife. Unlike metal parts, parts made from conventional plastics cannot be detected with detectors or x-ray devices. A new innovation at Friedr. Dick is the DetectoGrip detectable knife series and the Detecto Steel HyperDrill knife sharpener. By mixing metal parts into the plastic, pieces of plastic can now be detected in food by commercial metal detectors and x-ray devices. In collaboration with our plastic manufacturer, a material has been developed that has further improved the detectability of this plastic mixture. This has been successfully proven in internal and external tests.

DetectoGrip, série détectable

Seuls les couteaux et outils à manche en plastique peuvent être utilisés pour la transformation de la viande. Or les manches en plastique souple présentent un risque d'abrasion et des particules extrêmement fines risquent donc de se retrouver dans les produits alimentaires. Pour éviter ces problèmes, on peut utiliser des couteaux et outils à manche en plastique rigide. Mais là aussi, les aliments peuvent être contaminés par des particules de métal et de plastique si le couteau est endommagé. Contrairement aux particules de métal, les particules de plastique classique ne sont pas détectées par les détecteurs et appareils de radiographie. Friedr. Dick propose maintenant deux nouveaux produits : la série de couteaux détectables DetectoGrip et l'affûteur Detecto Steel HyperDrill. Le plastique utilisé dans ces produits est mélangé à des particules de métal et est donc à présent également détectable par les détecteurs à métaux et les appareils de radiographie du commerce. En collaboration avec notre fabricant de plastique, nous avons mis au point un matériau grâce auquel la détectabilité de ce mélange plastique a encore été perfectionnée. Des tests réalisés en interne et en externe ont permis de contrôler et confirmer cela.

Deshuesador flexible

Boning knife, flexible

Désosseur, flexible

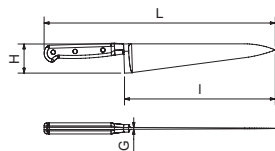

L	I	H	G	Gr	Barcode	€
252	130	20	1	115	440510	23,00
271	150	23	1	120	440512	25,00

Deshuesador semiflexible

Boning knife, semi-flexible

Désosseur, semi-flexible

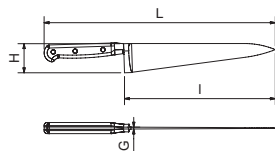

L	I	H	G	Gr	Barcode	€
252	130	20	1,1	115	440514	23,00
271	150	23	1,4	120	440516	25,00

Deshuesador

Boning knife

Désosseur

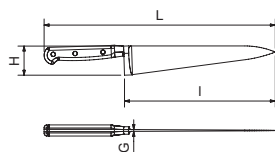

L	I	H	G	Gr	Barcode	€
279	150	23	2,1	120	440518	25,00

Cuchillo sangrado

Sticking knife

Couteau à saigner

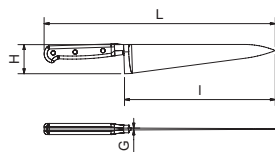

L	I	H	G	Gr	Barcode	€
310	180	38	2,2	115	440520	30,00

Cuchillo para despiece

Butcher's knife

Couteau à découper

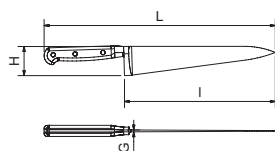

L	I	H	G	Gr	Barcode	€
335	210	42	2,1	180	440522	34,00

L	I	H	G	Gr	Barcode	€
190	90	100	1	35	444206	18,00

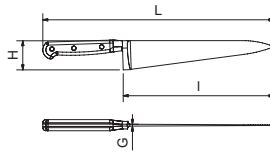

Pelador
Peeling knife
Éplucheur



L	I	H	G	Gr	Barcode	€
210	115	40	1	50	440502	20,00

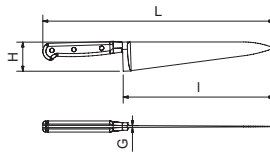

Verduras
Vegetable knife
Légumes



L	I	H	G	Gr	Barcode	€
250	140	45	2	65	440420	26,00

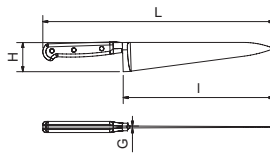

Modelo cocina
Kitchen knife
Modèle cuisine



L	I	H	G	Gr	Barcode	€
290	180	50	2	115	440250	28,20

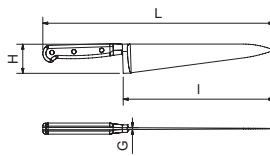

Modelo cocinero
Chef's knife
Modèle cuisinier



L	I	H	G	Gr	Barcode	€
360	230	25	1,4	115	446050	26,20

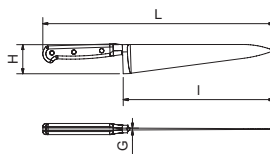

Lenguado
Fish fillet knife
Sole



L	I	H	G	Gr	Barcode	€
270	160	33	2	110	447116	34,00

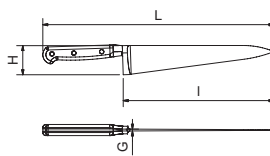

Santoku
Santoku knife
Couteau Santoku



L	I	H	G	Gr	Barcode	€
290	170	29	2	110	447120	27,50

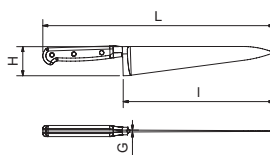

Panero
Bread knife
Couteau à pain



Cuchillos contrapesados

Counter-balanced knives

Couteaux contrebalancés

Características de fabricación:

Al empuñar y manejar un cuchillo debemos asegurarnos que nos sentimos cómodos y que el centro de gravedad es el adecuado a nuestra forma de utilizarlo.

Algunos cuchillos, incluso tienen la posibilidad de variar el centro de gravedad, insertando piezas de diferente peso hasta conseguir la mejor sensación para cada usuario.

Los cuchillos de calidad tienden a tener muy buen equilibrio sin demasiado peso ya sea en la cuchilla o en el mango.

Un cuchillo de calidad y bien equilibrado se equilibrará en ese punto y no se caerá de su dedo.

Manufacturing characteristics:

Wielding a knife handle and we must ensure that we are comfortable and that the center of gravity is the right way to use our.

Some knives, even have the possibility to vary the center of gravity, inserting pieces of different weight to get the best feel for each user.

Quality knives tend to have very good balance without too much weight either the blade or the knife mango.

Un quality and well balanced will be balanced at that point and will not fall off your finger.

Caractéristiques de fabrication:

Brandissant une poignée de couteau et nous devons nous assurer que nous sommes à l'aise et que le centre de gravité est la bonne façon d'utiliser notre. Certains couteaux, ont même la possibilité de faire varier le centre de gravité, en insérant des morceaux de différents poids pour obtenir la meilleure sensation pour chaque utilisateur. couteaux de qualité ont tendance à avoir un très bon équilibre sans trop de poids, soit la lame ou la qualité de mango. Un couteau et bien équilibré sera équilibré à ce moment-là et ne tombent pas votre doigt.



Cuchillo de Chef contrapesado

Counter-balanced chef's knife
Couteau de chef contrebalancé

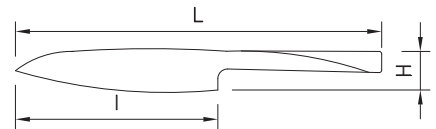

L	I	H	Gr	Barcode	€
380	210	40	780	441102	132,00

Cuchillo multiusos y pelador contrapesado

Counter-balanced multi-purpose and peeling knife
Couteau multi-usage et éplucheur contrebalancé

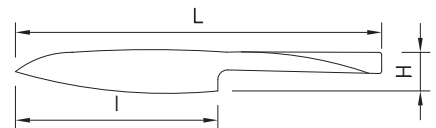

L	I	H	Gr	Barcode	€
300	120	40	500	441104	97,00

Cuchillo deshuesado contrapesado

Counter-balanced boning knife
Couteau à desosser contrebalancé

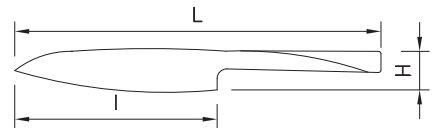

L	I	H	Gr	Barcode	€
300	160	40	680	441106	108,00

Cuchillo Santoku contrapesado

Counter-balanced santoku knife
Couteau Santoku contrebalancé

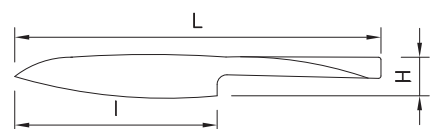

L	I	H	Gr	Barcode	€
380	180	40	780	441108	133,00

Maletín cuchillos cocinero Victorinox

Victorinox chef knife case
Malette couteaux de cuisinier Victorinox



14 piezas según detalle:

Cuchillo para trinchar, hoja ancha
Cuchillo pastelero, filo dentado
Espátula flexible
Chaira redonda, 27cm
Cuchillo decorador, hoja curva
Pelador de papas, un solo filo
Sacabocados doble (Ø22 + 25mm)
Decorador de limón
Rallador de limón
Cuchillo de cocina
Cuchillo deshuesador, hoja recta
Cuchillo para filetear, hoja flexible
Tenedor trinche, forjado
Cuchillo para trinchar, hoja ancha

14 piece knife set. Set contains the following:

Carving knife, broadleaf
Pastry knife, serrated edge
Flexible spatula
Rounded sharpening steel
Decorator knife, curved blade
Peeling knife, one edge
Wrecking knife, double edge
Lemon decorator knife
Lemon zester
Kitchen knife
Straight bonning knife
Filleting knife, flexible blade
Carving fork, forged
Carving knife, broadleaf

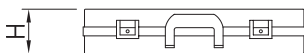
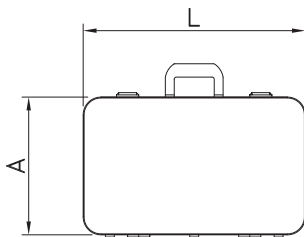

L	A	H	Kg	Barcode	€
490	310	100	5,0	448052	652,00

14 pièces selon détails:

Couteau à découper, lame large
Couteau à pâtisserie, bord denté
Spatule flexible
Fusil à affûter rond, 27 cm
Couteau à décorer, lame courbée
Éplucheur de patates, un seul bord
Découpoir double (Ø22 + 25mm)
Couteau à décorer pour citron
Râpe à citron
Couteau de cuisine
Couteau à décoster, lame droite
Couteau filet, lame flexible
Fourchette à découper, forgée
Couteau à découper, lame large

Kit de útiles para barbacoa

BBQ utensil set
Kit d'accessoires pour barbecue

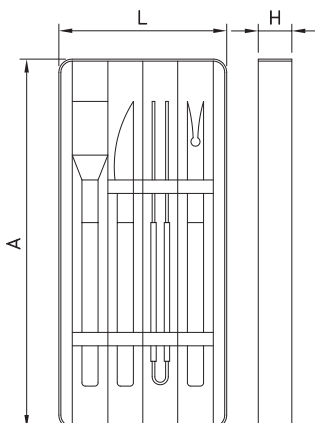

L	A	H	Gr	Barcode	€
550	250	50	950	440062	72,00

Tijeras

Scissors
Ciseaux

Tijeras pescadero

Fish scissors
Ciseaux à poisson

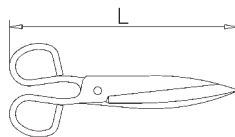

L	Gr	Barcode	€
160	85	446802	9,00
180	115	446804	11,20
200	155	446806	12,00
220	200	446808	14,50
240	260	446810	23,50
260	340	446812	30,60
280	415	446814	34,70

Tijera pescadero / cocina con protección

Kitchen / fish scissors with protection
Ciseaux de poissonniers / de cuisine avec protection

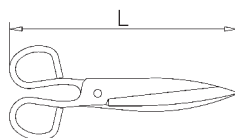

L	Gr	Barcode	€
240	274	446816	21,00

Tijeras de trinchar

Chicken knife
Couteau à poulets

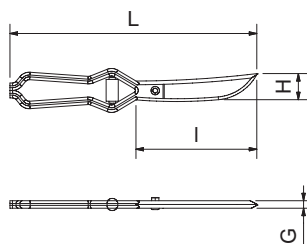

L	I	H	G	Gr	Barcode	€
260	125	20	10	270	446850	14,40

Tijera desmontable multiusos

Detachable multi-purpose scissors
Ciseaux multi-usages démontables

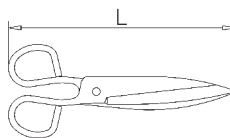

L	Gr	Barcode	€
200	160	446854	38,20

Tijeras multiusos

Multi purpose scissors
Ciseaux multi-usages

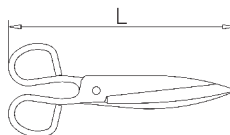

L	Gr	Barcode	€
215	160	446852	15,20

Tijera profesional

Professional scissors
Ciseaux professionnelles

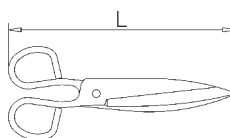

L	Gr	Barcode	€
210	290	446856	62,00
245	505	446858	84,00



Afiladores Knife-sharpener Aiguiseur



L	I	H	Gr	Ø	Barcode	€
440	305	11	360	Ø	447202	16,00
490	350	20-10	380	Ø	447204	37,00

Sus principales ventajas son su ligereza y una mayor vida útil frente al resto de chairas.

Fabricada con cerámica de alta y avanzada tecnología.

Recomendada para cuchillos fabricados con aceros y aleaciones especiales de cuchillería, como molibdeno-vanadio, CROMOVA 18, etc. No válida para cuchillos cerámicos.

Excelente resultado del afilado.



L	I	H	Gr	Ø	Barcode	€
380	245	14,00	160	Ø	447206	40,00

Su principal ventaja es la posibilidad de afilar todo tipo de cuchillos, incluso los cerámicos.

La hoja de acero cubierta de diamante en polvo permite obtener un resultado particularmente fino de afilado. La capa de diamante se desgasta con el tiempo, acortando poco a poco la vida útil del utensilio. Se recomienda utilizarla complementariamente a la chaira de acero.

El mango inyectado en polipropileno proporciona gran ergonomía a la vez que firmeza en la sujeción, con diseño protector y anilla para colgar.

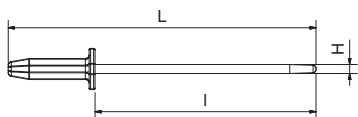

L	I	H	Gr	Ø	Barcode	€
440	305	20>10	295	Ø	447208	67,00

Chairas

Sharpener
Fusil à affûter



Chaira cerámica

Ceramic sharpener
Fusil à aiguiser en céramique



Its main advantages are its lightness and durability compared with other sharpeners.

Made of high and advanced technology ceramic.

Recommended for knives manufactured with steel and special alloys for knives, such as molybdenum-vanadium, CROMOVA 18, etc. It is not valid for ceramic knives.

Excellent sharpening results.

Ses principales avantages sont sa légèreté et de durabilité par rapport à d'autres taille.

Fabriqué en céramique de haute et avancée technologie.

Recommandé pour les couteaux fabriqués avec des aciers et alliages spéciaux, tels que le molybdène vanadium, CROMOVA 18, etc. Il n'est pas valable pour les couteaux en céramique.

Excellente netteté des résultats.

Chaira diamantada

Diamond sharpener
Fusil à aiguiser diamanté



Its main advantage is the possibility of sharpening all kind of knives, even the ceramic ones.

The steel blade covered with diamond powder has as a result a especially fine blade sharpening. The diamond layer wears out over time, shortening gradually the life of the tool. It is recommended to use it alternatively with the steel sharpener.

The injected polypropylene handle offers a great ergonomics together with firmness in gripping, a protective design. Provided with hanging ring.

Ses principales avantage est la possibilité d'affûter tous les types de couteaux, même les céramiques.

La lame en acier recouvert de poudre de diamant a la suite d'un aiguisage de la lame particulièrement fin. La couche de diamant s'use au fil du temps, le raccourcisse progressivement la durée de vie de l'outil. Il est recommandé de l'utiliser en alternance avec le fusil à aiguiser en acier.

La poignée en polypropylène injecté offre une grande ergonomie avec fermeté à saisir et une conception de protection. Fourni avec anneau de suspension.

Afilador cuchillos manual de sobremesa

Manual knife-sharpener for worktop
Aiguseur manuel sur table

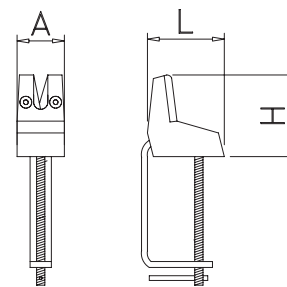

L	A	H	Gr	Barcode	€
60	66	40	380	448304	123,00

L	A	H	Gr	Barcode	€
---	---	---	----	---------	---

Cuchillas de repuesto para afilador 448304

Spare blades for knife-sharpener 448304
Lames de rechange pour l'affûteur 448304

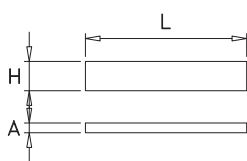

Juego de 4 cuchillas, 2 gomas protectoras grandes (63x48 mm.)
y 1 goma protectora pequeña (45x20 mm.)

Set of 4 blades, 2 large protective rubbers (63x48 mm.) and 1 small protective rubber (45x20 mm.)
Ensemble de 4 lames, 2 caoutchoucs de protection grandes (63x48 mm.) et un caoutchouc de protection petite (45x20 mm.)

33	2	6	33	448354	63,00
----	---	---	----	--------	-------

Afilador de cuchillos manual de sobremesa

Manual knife-sharpener for worktop
Aiguseur de Couteaux manuel sur table

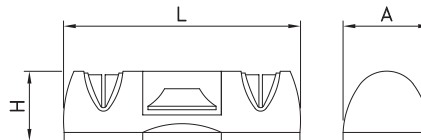

L	A	H	Gr	Barcode	€
135	75	40	174	448302	21,00

Afilador de cuchillos manual de sobremesa

Manual knife-sharpener for worktop
Aiguseur de couteau manuel sur table

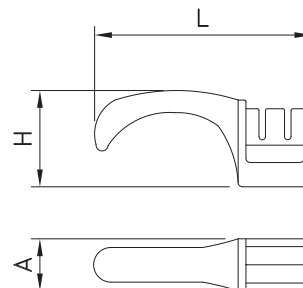

L	A	H	Gr	Barcode	€
200	60	100	200	448310	14,00

Afilador detectosteel

DetectoSteel knife-sharpener
Aigiseur detectoSteel

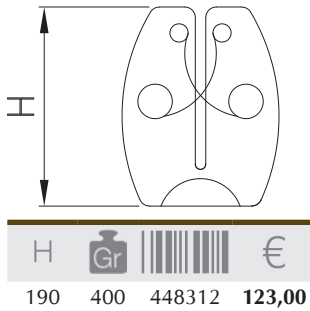

Afilador de cuchillos profesional

Professional knife-sharpener
Aigiseur professionnel



Características:

Esmeriladora E200/150. Carcasa de acero. Motor silencioso con rodamientos de bolas. Adecuada para trabajos generales de taller. Depósito de agua para muela 200x40x20 mm. Incluye muelas y protectores.

Muela: $\varnothing 150 \times 20 \times 12,7$ mm.

rpm: 2.950

Muela: $\varnothing 200 \times 40 \times 20$ mm.

rpm: 134

Characteristics:

Grinder E200/150. Steel case. Silent engine with ball-bearing. Suitable for general use at workshops. Water tank for grindstone 200x40x20 mm. Grindstone and protective cover included.

Grindstone: $\varnothing 150 \times 20 \times 12.7$ mm.

Rpm: 2,950

Grindstone: $\varnothing 200 \times 40 \times 20$ mm.

Rpm: 134

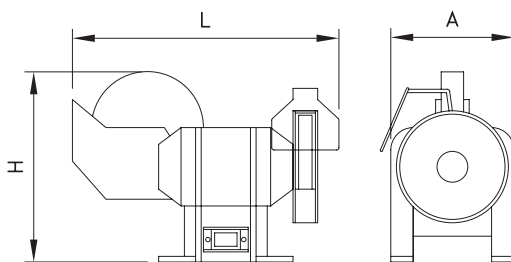

Caractéristiques:

Touret d'affutage E200/150. Boîtier en acier. Moteur silencieux avec roulement à billes. Approprié pour une utilisation générale dans les ateliers. Réservoir d'eau pour meule 200x40x20 mm. Meule et couvertes de protection inclus.

Meule: $\varnothing 150 \times 20 \times 12.7$ mm.

Rpm: 2,950

Meule: $\varnothing 200 \times 40 \times 20$ mm.

Rpm: 134

L	A	H	Potencia Power Puissance	Tensión Voltage Tension	Frecuencia Frequency Fréquence	Kg	€
415	260	245	270 W	220 V	50 Hz	12	448306 158,00

D	G	Gr	€
150	20	150	448350 41,00

Repuesto de muela (grano 60) para afilador 448306
Spare grindstone (grit 60) for knife-sharpener 448306
Meule de rechange (grain 60) pour affûteur 448306



Portacuchillos

Mounted knife
Porte-couteaux

Portacuchillos para adosar con envoltente

Mounted knife holder with wrapping
Porte-couteaux pour adosser avec enveloppant



Capacidad: 18 cuchillos
Capacity: 18 Knives
Capacité: 18 couteaux



Acoplar portacuchillos
Assembly knife holder
Assembler porte-couteaux

€

23,00



Este precio no incluye el portacuchillos
Knife-holder not included in this price
Porte-couteaux n'inclus pas dans ce prix

Cuchillero con alojamiento especial para tijeras y chairas.

Knife-holder with special lodging for scissors and sharpeners.

Porte-couteaux avec logement spécial pour ciseaux et fusils à affûter.

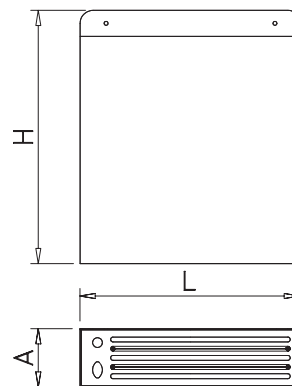

L	A	H	Kg	Barcode	€
380	90	420	3,75	040602	75,00

Portacuchillos portátil

Portable knives holder
Porte couteaux transportable



Capacidad: 20 cuchillos
Capacity: 20 Knives
Capacité: 20 couteaux

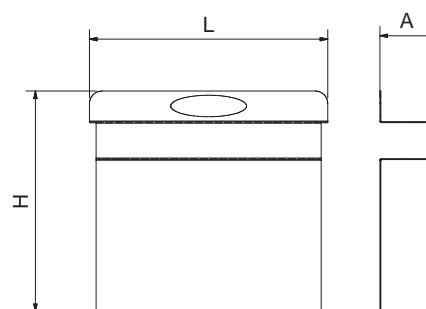

L	H	A	Kg	Barcode	€
377	350	86	2,40	041050	48,00

Contenedor para transporte de cuchillos

Container for knives transport
Conteneur pour déplacer les couteaux

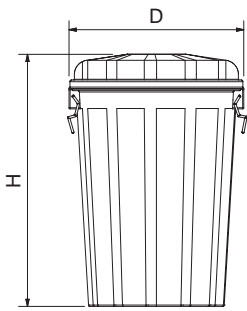

H	D	Kg	Barcode	€
730	495	8,5	041062	70,00

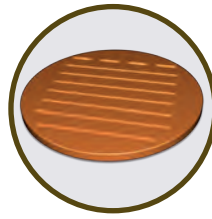

Barcode €
431518 48
Repuesto fibra
Spare fibre
Plaque de rechange

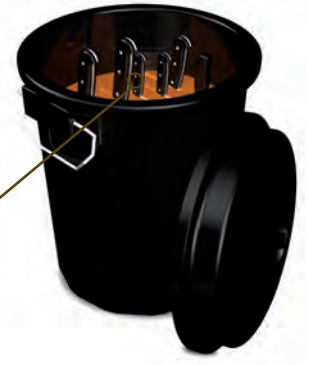

Contenedor para transporte de cuchillos con ruedas

Container for knives transport with wheels
Conteneur pour déplacer les couteaux avec des roues

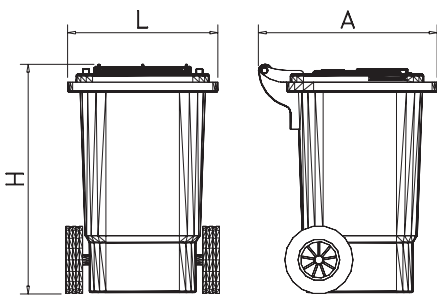

L	A	H	Kg	Barcode	€
470	550	670	11,00	041060	115,00

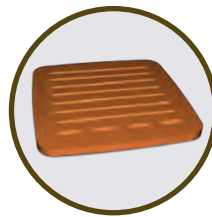

Barcode €
431516 42
Repuesto fibra
Spare fibre
Plaque de rechange



Portacuchillos con doble alojamiento de sobremesa

Worktop knife holder with dual housing
Porte-couteaux avec deux logements pour placer sur table

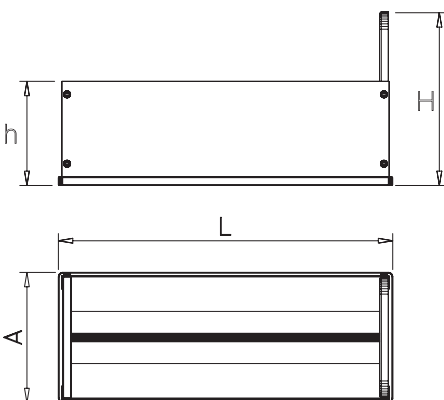

L	A	h	H	Kg	Barcode	€
435	165	140	200	3,73	041202	125,00



Capacidad: 20 cuchillos
Capacity: 20 Knives
Capacité: 20 couteaux



Construido en acero inoxidable
y polietileno calidad P-500.

Constructed in stainless steel and P-500 quality
polyethylene.

Fait en acier inoxydable et polyéthylène qualité
P-500.

Portacuchillos para adosar en varilla

Rod mounted knife holders
Porte-couteaux pour adosar sur tringle



Acoplar portacuchillos
Assembly knife holder
Assembler porte-couteaux

€

23,00



Este precio no incluye el portacuchillos.
Knife-holder not included in this price.
Porte-couteaux n'inclus pas dans ce prix.

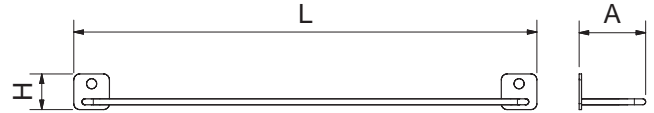

L	H	A	Gr	Barcode	€
340	30	51	270	040802	38,00
390	30	51	300	040804	41,00
440	30	51	330	040806	44,00

Portacuchillos para adosar en chapa

Plated knife holders for mounting
Porte-couteaux plaqué pour adosar



Acoplar portacuchillos
Assembly knife holder
Assembler porte-couteaux

€

23,00



Este precio no incluye el portacuchillos.
Knife-holder not included in this price.
Porte-couteaux n'inclus pas dans ce prix.

Cuchillero con alojamiento especial para tijeras y chairas.
Knife-holder with special lodging for scissors and sharpeners.

Porte-couteaux avec logement spécial pour ciseaux et fusils à affûter.



Capacidad: 18 cuchillos
Capacity: 18 Knives
Capacité: 18 couteaux

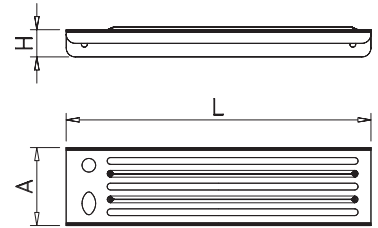

L	A	H	Gr	Barcode	€
380	90	30	600	041002	20,00
450	90	30	730	041004	24,00

Portacuchillos mural imantado

Magnetic wall knife holder
Porte-couteaux de mur magnétique

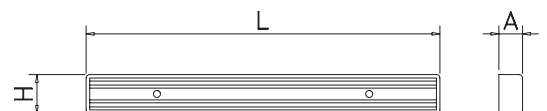

L	A	H	Gr	Barcode	€
460	25	43	500	448472	18,00

Portacuchillos mural imantado de acero inoxidable

Magnetic knife-holder in stainless steel
Porte-couteaux magnétique en acier inoxydable

Fabricado en acero inoxidable.

Su gran poder de magnetismo asegura una buena fijación de la cuchillería.

Ideal para la industria alimentaria, muy recomendable en pescaderías.

Made in stainless steel
High magnetism to ensure a perfect holding of knives
Recommended for food industry, especially in fish-mongers

Fabriqué en acier inoxydable.

La puissance de son magnétisme assure une bonne fixation de la coutellerie.

Idéal pour l'industrie alimentaire, usage très recommandé en poissonnerie.

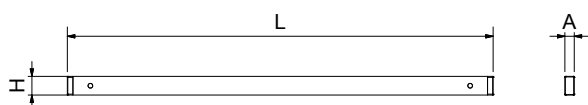

L	H	A	Gr	Barcode	€
257	20	10	500	041602	49,00



Manta para 7 útiles de cocina

Holster for 7 cooking tools
Trousse de chef pour 7 couteaux

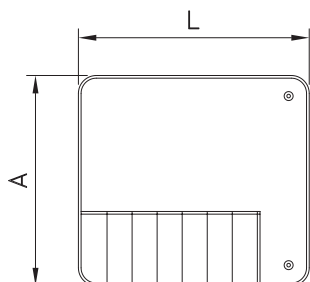

L	A	Gr	Barcode	€
285	235	103	448054	15,00



útiles de cocina no incluidos
Cooking tools not included
Couteaux non inclus

Manta para cuchillos

Cook case
Trousse de chef

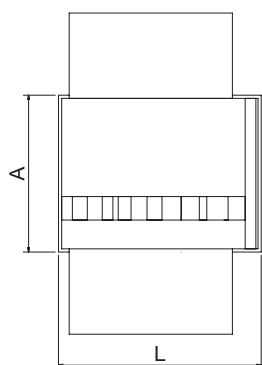

L	A	Gr	Barcode	€
575	440	450	448056	40,00



Cuchillos no incluidos
Knives not included
Couteaux ne sont pas inclus



Menaje
Kitchenware
Ustensiles de cuisine

Pinza para frituras

Frying tongs
Pince à friture

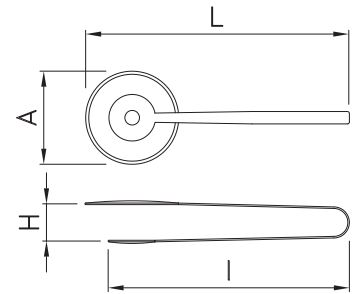

L	I	A	H	Gr	Barcode	€
340	310	117	15	310	440006	5,00

Pinza de servir

Serving tongs
Pinces à servir

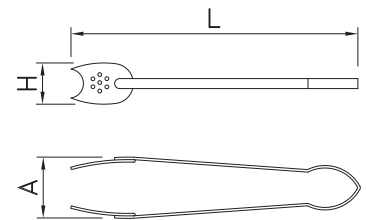

L	A	H	Gr	Barcode	€
230	45	32	200	440002	7,00

Pinza para barbacoa

Barbecue tongs
Pince de barbecue

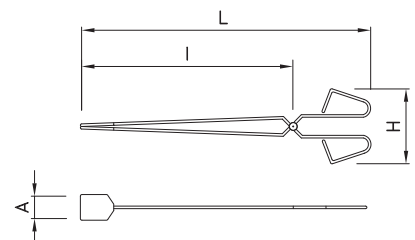

L	I	A	H	Gr	Barcode	€
400	300	45	90	250	440004	9,00

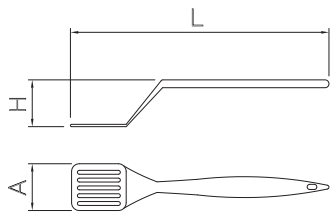

L	A	H	Gr	Barcode	€
330	70	60	170	440038	5,00

Paleta
Slotted turner
Pelle

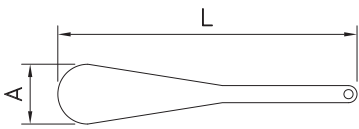

L	A	Gr	Barcode	€
250	50	39	483220	3,00
300	60	65	483222	4,00
350	70	93	483224	6,00
400	80	112	483226	9,00
500	90	184	483228	11,00

Espátulas
Spatula
Spatules



Ver pag. 414
See page 414
Voir page 414

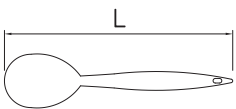

L	Gr	Barcode	€
300	43	483230	3,00

Cuchara de cocina
Spoon
Cuillère



Ver pag. 414
See page 414
Voir page 414

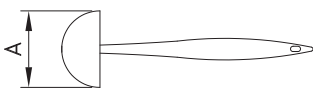
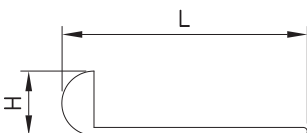

L	A	H	Gr	Barcode	€
300	95	80	200	440032	5,00

Cazo
Ladle
Louche

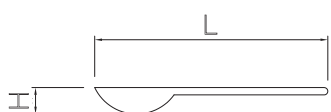

L	A	H	Gr	Barcode	€
325	76	36	150	440034	5,00

Cucharón de servir
Serving spoon
Cuillère à servir



Espumadera

Slotted spoon
Écumaire

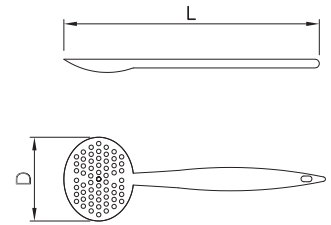

L	D	Gr	Barcode	€
300	95	180	440036	5,00

Batidor

Whisk
Fouet

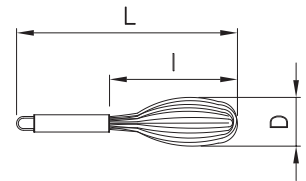
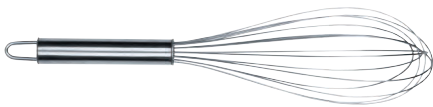

L	I	D	Gr	Barcode	€
270	160	60	180	440014	4,50

Colador

Colander
Passoir

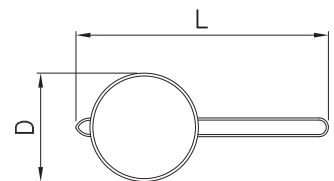

L	D	Gr	Barcode	€
320	150	180	440011	13,00

Colador/Tamizador

Colander/Chinese strainer
Passoire/Chinois étamine inox

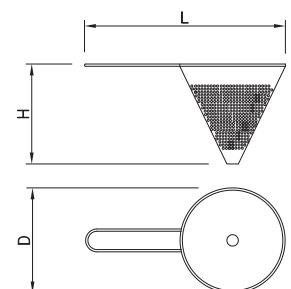

L	D	H	Gr	Barcode	€
340	170	150	400	440010	19,00

Escurreidor de verduras

Vegetable drainer
Égouttoir légumes

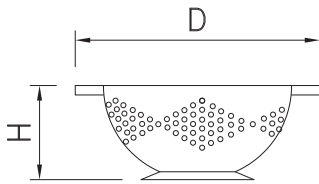

H	D	Gr	440060	€
100	305	250	440060	10,00

Escurreidor de ollas regulable

Multi-colander
Passoire multiple



Novedad
ew
nuevo

Características:

Acoplable a varios diámetros.

Characteristics:

Coupled with various diameter.

Caractéristiques:

Adaptables à différents diamètre.

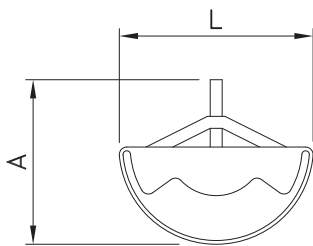

L	A	Gr	440072	€
230	220	110	440072	8,00

Volteadora de tortilla inox

Stainless steel omelette turn over lid
Couvercle retourne-omelette inox



Novedad
ew
nuevo

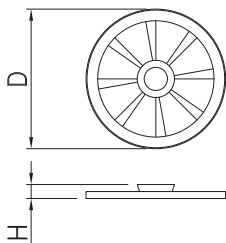

D	H	Gr	440910	€
300	15	250	440910	8,00

Librador

Scoop
Cornet



Novedad
ew
nuevo

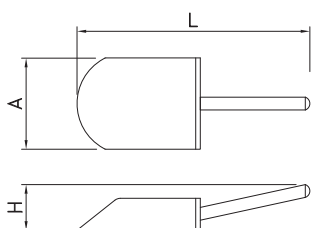

L	A	H	Gr	440074	€
120	80	35	150	440074	9,00
160	100	50	170	440076	11,00
200	140	60	200	440078	14,00

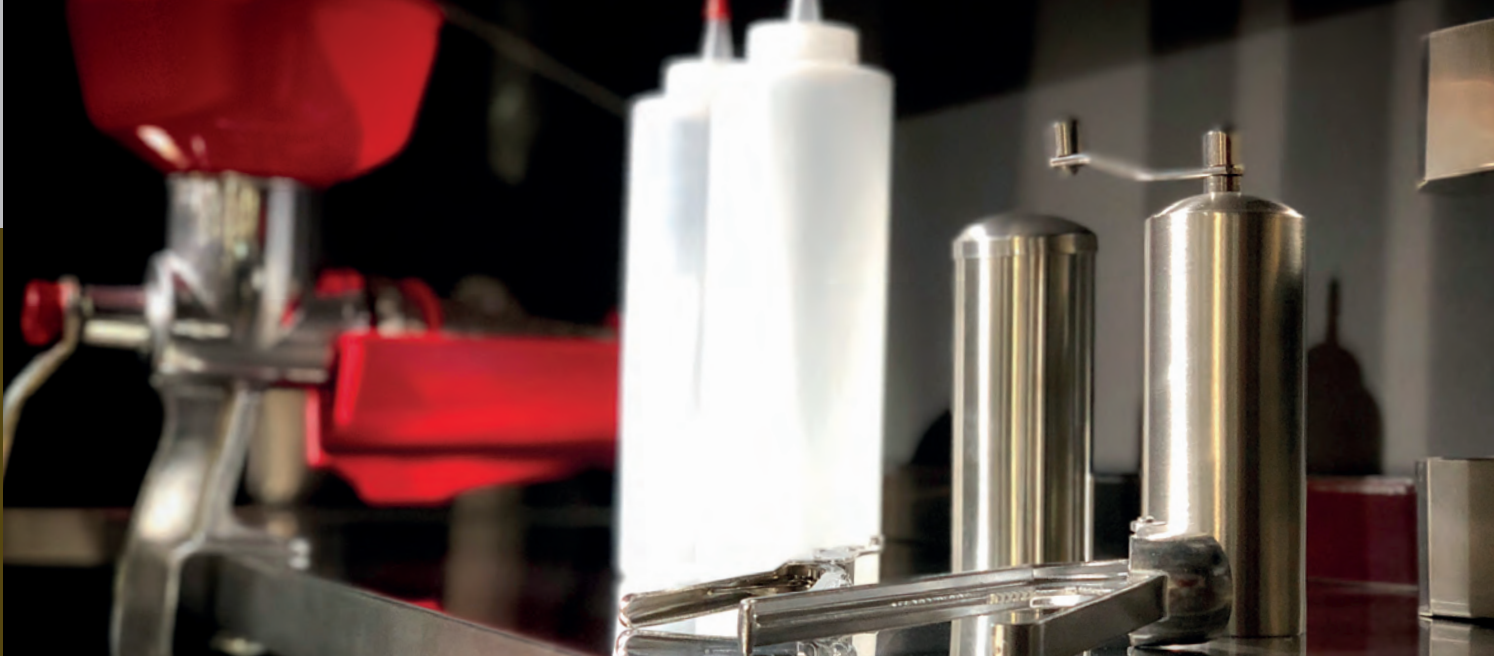

Utensilios de cocina
 Cooking utensils
 Ustensiles de cuisine

Pelador

Peeler
 Éplucheur

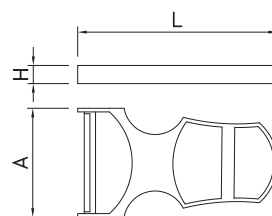

L	A	H	Gr	Barcode	€
110	60	10	80	446903	3,00

Abrelatas tenaza

Can opener
 Ouvre-boîte

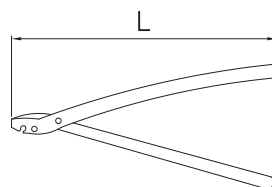

L	Gr	Barcode	€
150	125	440020	4,00

Abrelatas

Can opener
 Ouvre-boîtes

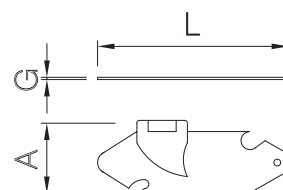

L	A	G	Gr	Barcode	€
80	30	2	50	440019	1,80

Abrelatas industrial

Industrial can opener
Ouvre-boîtes industriel

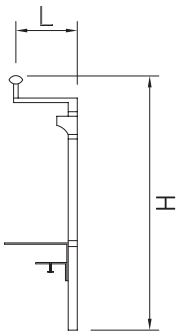

L	H	Kg	Barcode	€
150	550	1,80	440021	132,00



Repuesto roldana para abrelatas industrial 440021
Spare cog for commercial can opener 440021
Pièce de rechange, engrenage pour ouvre-boîte industriel 440021

35 440090 **11,50**



Repuesto cuchilla para abrelatas industrial 440021
Spare blade for commercial can opener 440021
Pièce de rechange, lame pour ouvre-boîte industriel 440021

7 440092 **7,50**

Conjunto de 6 aros de emplatar en acero inox

Rings mold set in stainless steel - 6 pieces
Set de 6 moules à dresser en acier inox

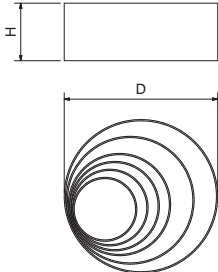

L	A	H	Gr	Barcode	€
230	155	50	207	440064	12,00

Moldes cuadrados

Square pastry mould
Cercle carre pour pâtisserie

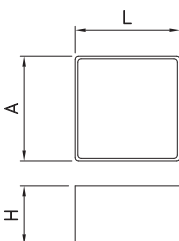

Características:
Para emplatar, cortar pastas, hornear...

Characteristics:
For plating, cookies cutting, baking...

Caractéristiques:
Alimentaire décoration, coupe pâtes, cuisson...



L	A	H	Gr	Barcode	€
60	60	45	60	440080	4,50
70	70	45	70	440082	4,60
80	80	45	90	440084	4,70
90	90	45	100	440086	5,00
100	100	45	110	440088	5,10

Enrollador de maki super-higiénico

Sushi rolling mat, ultra-hygienic
Enrouleur de maki super-hygiénique

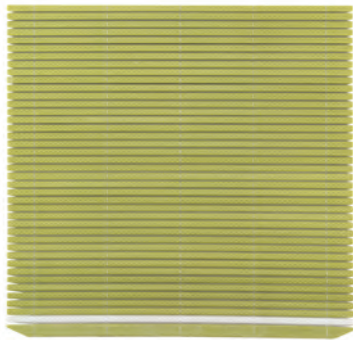

Les meilleurs enrouleurs super-hygiéniques de makis avec une grande capacité antiadhésive du riz. Un enrouleur révolutionnaire qui n'utilise pas les traditionnelles baguettes de bambou ni du coton pour sa couture, sinon des plastiques et des monofilaments avancés. Non seulement ils sont hygiéniques, mais aussi faciles de rouler comme un enrouleur traditionnel.

Avantages principaux :

- Aussi facile de rouler que les conventionnels en bambou.
- Ne génère pas d'éclats ou de moisissure noire, comme les bambous conventionnels
- Les monofilaments de couture repoussent la contamination.
- Une probabilité moindre que le riz s'adhère à ses surfaces en relief.
- Apte pour le lave-vaisselles
- Sèche rapidement pour pouvoir être utilisé après le lavage.



Los mejores enrolladores super-higiénicos de makis con gran capacidad antiadherente del arroz.

Un enrollador revolucionario que no hace uso de las tradicionales varitas de bambú ni del algodón para su cosido, sino de plásticos y monofilamentos avanzados.

No sólo son higiénicos, sino también fáciles de rodar como un enrollador tradicional.

Principales ventajas:

- Apto para lavavajillas.
- No genera astillas o moho negro, como los bambúes convencionales.
- Los monofilamentos del cosido repelen la contaminación.
- Menor probabilidad de que el arroz se adhiera a sus superficies en relieve.
- Rápido secado para poder ser utilizado después del lavado.
- Tan fácil de rodar como los enrolladores convencionales de bambú.

The best makisu ever that are super hygienic and less likely to stick to rice.

A revolutionary makisu that makes use of neither the traditional bamboo nor cotton strings but advanced plastic and monofilaments.

They are not only hygienic but also easy to roll as a makisu.

Designed with several benefits below.

- Dishwasher safe, bleach safe.
- Does not generate splinters or black mold, like the those conventional bamboo ones always does.
- The monofilaments that deter contamination are used for the binding strings.
- Rice less likely to stick to its embossed surfaces.
- Easy to dry so that can be used soon after washing.
- Yet as easy to roll as conventional bamboo ones.

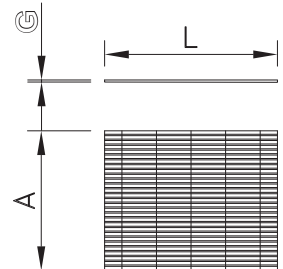

L	A	G	Gr	Barcode	€
250	165	3	110	434486	31,00
250	240	3	160	434488	36,00
250	305	3	200	434490	42,00

Pimentero

Pepper
Moulin à poivre



Características:

Pimentero construido en acero inoxidable, elegante y funcional. Equipada con el exclusivo cono molidor Tre Spade fabricado en un acero templado. Mecanismos y muela protegida de corrosión. Dientes de alta precisión.

Characteristics:

Pepper mill made of stainless steel, extremely elegant and functional. Equipped with the exclusive Tre Spade conical grinding mechanism made of special tempered steel. Surface protection to protect grinding mechanisms from corrosion. High precision teeth.

Caractéristiques:

Moulin à poivre réalisé en acier inox, extrêmement élégant et fonctionnel. Équipé de meules coniques exclusives Tre Spade en acier trempé spécial. Protection anti-rouille à la surface des meules. Dentures de précision.

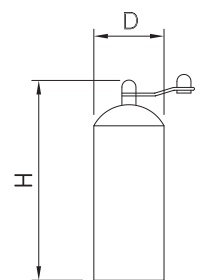

D	H	Gr	Barcode	€
50	150	420	440046	47,00

Salero

Salt shaker
Salière



Características:

Salero de gran capacidad construido en acero inoxidable. Elegante y funcional.

Characteristics:

Salt shaker with large holding capacity. Made of stainless steel, extremely elegant and functional.

Caractéristiques:

Salière au réservoir de grande capacité. Réalisée en acier inox, extrêmement élégante et fonctionnelle.

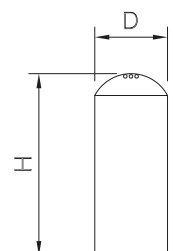

L	H	Gr	Barcode	€
50	125	380	440048	33,00

Especiero inox con tres niveles

Spice rack three levels
Armoire à épices



Características:

Fabricado totalmente en acero inoxidable.
Posibilidad de limpieza en lavavajillas.
Fácil colocación en pared. Dotado de tornillos inoxidables y tacos.
Capacidad de hasta 24 dosificadores.
3 niveles de clasificación.

Characteristics:

Fully constructed in stainless steel.
Dishwasher safe.
Easy wall-fitting. Supplied with plugs and stainless screws.
Capacity for up to 24 spice shakers.
3 rack levels.

Caractéristiques:

Fabriquée totalement en acier inoxydable.
Lavable en lave-vaisselle.
Facile fixation. Vis inoxydables et taquets inclus.
Capacité jusqu'à 24 récipients.
3 niveaux de rangements.

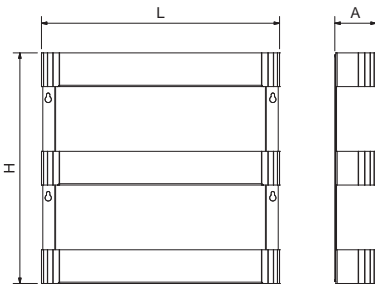

L	A	H	Kg	040204	€
353	61	342	1,4	040204	47,00

Molinillo de hierbas

Herb mill
Moulin à herbes

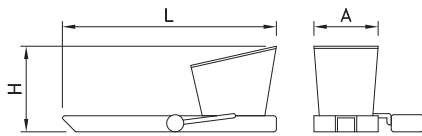

L	A	H	Gr	440902	€
200	60	80	110	440902	12,00

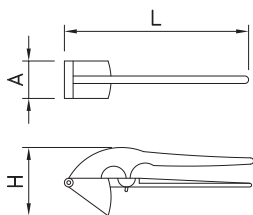

L	A	H	Gr	440042	€
150	30	55	190	440042	6,00

Prensa ajos

Garlic press
Presse-ail



Rallador de queso

Cheese grater
Râpe à fromage

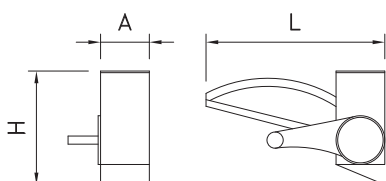

L	A	H	Gr	447914	€
220	140	60	250	447914	16,00

Construido en acero inoxidable
2 bombos

Stainless steel
2 drums

Inox
2 tambours

Rallador inox

Stainless steel grater
Râpes inox



Novedad
ew
ouveau

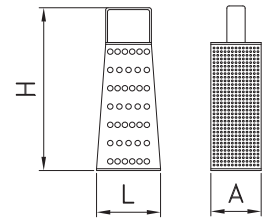

L	A	H	Gr	Barcode	€
70	55	180		447916	4,00

Molinillo juliana

Julienne mill
Moulin julienne



Novedad
ew
ouveau

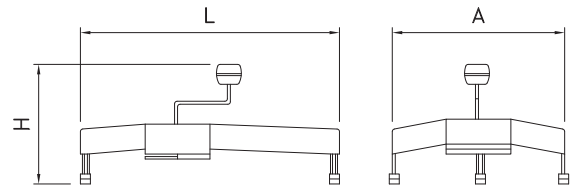

L	A	H	Gr	Barcode	€
180	260	60		440904	23,00

Pasapuré profesional

Professional food mill
Presse-purée professionnel



Novedad
ew
ouveau

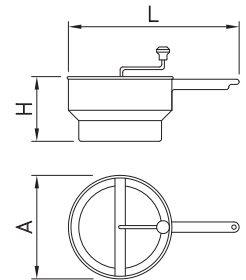

L	A	H	Gr	Barcode	€
330	200	120		440906	35,00

Picadora manual

Mincer
Hachoir



Novedad
ew
ouveau

Cuerpo de plástico
2 cuchillas
Plastic body
2 blades
Corps en plastique
2 lames

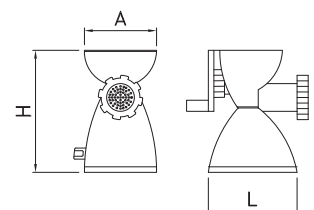

L	A	H	Gr	Barcode	€
220	180	130		447912	31,00

Picador de tomate

Tomato squeezer
Presse tomates

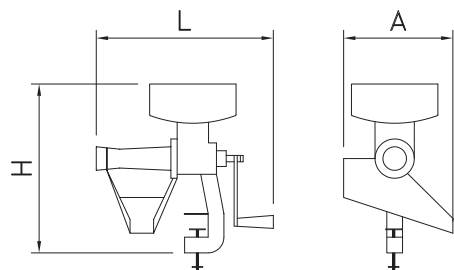

L	A	H	Kg	447904	€
500	290	400	1,70	447904	74,00



Triturador de hielo

Ice crusher
Broyeur à glace

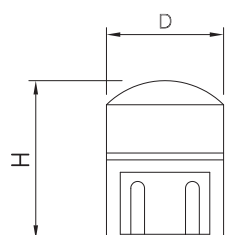

D	H	Gr	447902	€
150	260	700	447902	38,00



Cortadora de fiambres manual

Cold meat cutter
Trancheuse de charcuterie

Características:

Construida en acero inoxidable.
Diámetro del disco-cuchilla $\varnothing 120\text{mm}$
Desplazamiento de carro progresivo con un mango tipo ruleta que regula la anchura de corte.

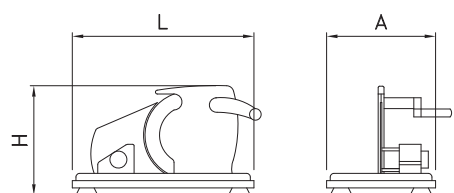

L	A	H	Kg	447906	€
250	150	150	1,00	447906	99,00

Characteristics:

Made of stainless steel
Blade disc diameter $\varnothing 120\text{mm}$
Progressive cutting carriage displacement, by a spinning handle for cutting adjustment

Caractéristiques:

Fabriquée en acier inoxydable.
Diamètre de la lame disque $\varnothing 120\text{mm}$
Déplacement progressif du chariot avec une poignée roulette qui règle la largeur de coupe.



Novedad
ew
ouveau

Punzonador de embutidos

Sausage punch
Outil perce-saucisse

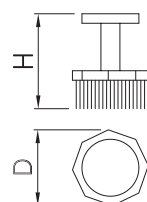

D	H	Gr	440028	€
40	50	50	440028	6,00



Abreostras

Oyster opener
Ouvre-huîtres

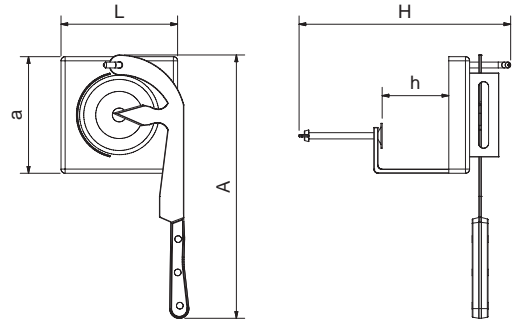

Se fija a la mesa mediante mordaza.
Table fixing by clamp.
Fixation au table sur mordache.

L	A	a	H	h	Kg	Barcode	€
140	325	140	250	75	1,16	447802	158,00

Abreostras

Oyster opener
Ouvre-huîtres

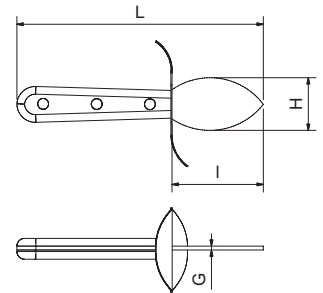

L	I	H	G	Gr	Barcode	€
165	65	85-32	2,4	120	447804	19,00

Embudo

Funnel
Entonnoir

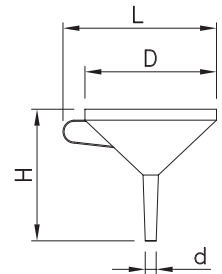

L	D	H	d	Gr	Barcode	€
145	125	115	17	150	440012	9,50

Biberones de cocina

Aqueeze bottle
Biberons de cuisine

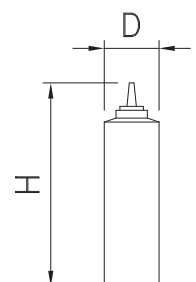

D	H	ml	Gr	Barcode	€
50	190	250 ml	33	440912	2,00
70	260	700 ml	59	440914	2,50

Conjunto dosificador de salsas y recipiente inox

Container and pump-dispenser set for sauce
Ensemble de distributeur-doseur de sauces et récipient inoxydable

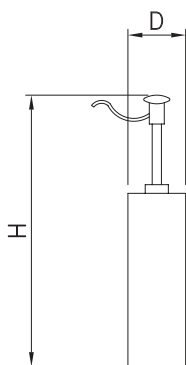

Bomba de 5 cc.
Cierre a presión.
Contenedor inox. con tapa plástica transparente.

Colored pumps 5 cc.
Snap closing.
Inox container with transparent plastic lid.

Pompe de 5 cc.
Fermeture à pression.
Récipient inox avec couvercle en plastique transparent.



Novedad
ew
niveau

D	A	H	lit	Gr	€
80	110	275	0,5 lts	400	64,00
					487283
					487292
					487294

Dosificador de salsas

Sauces dispenser
Distributeur de sauces

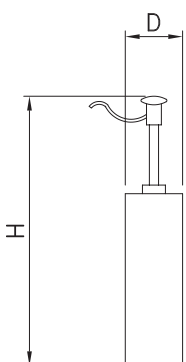

Porción de salsa: 30 gr. (ajustable)

Portion of sauce: 30 gr. (adjustable)

Portion de sauce: 30 gr. (réglable)



H	D	lit	Kg	€
455	100	2 lts	1,20	96,00
487282				

Conjunto dispensador de salsas

Sauce pump dispenser set
Distributeur de sauce avec 2 pompes

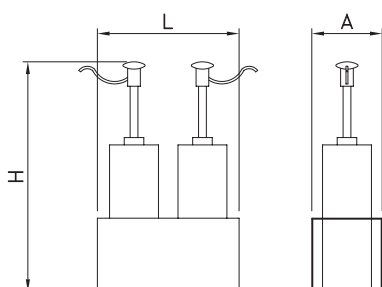

Porción de salsa: 30 gr. (ajustable)

Portion of sauce: 30 gr. (adjustable)

Portion de sauce: 30 gr. (réglable)



L	A	H	lit	Kg	€
290	145	470	2x 2 lts	4,90	267,00
487280					

Dosificador de salsas

Sauces dispenser
Distributeur de sauces

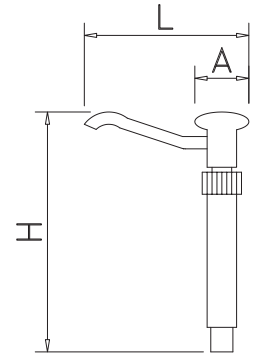

Concepto Concept Concept		€
Taladro Drill hole Tariere	082808	3,00

L	A	H			€
135	45	195	75	487278	40,00

Tapa dosificadora de salsas con cubo

Lid and pump-dispenser for sauce with bucket
Couvercle doseur de sauce avec seau



Características

Regulación progresiva hasta 40 gr.
Dosificador con mando de palanca inox.
Cubo de plástico incluido.
Para ancho de boca max. 195 mm.

Characteristics:

Variable adjustment up to 40 g
Stainless dosing dispenser lever
Plastic bucket included
Maximum mouth width supported: 195 mm.

Caractéristiques:

Régulation progressive jusqu'à 40 gr.
Distributeur avec commande de levier en acier inoxydable
Seau en plastique inclus.
Pour la largeur de la bouche max. 195 mm.

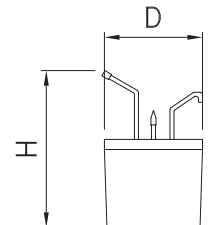

D	H				€
195	310	3-3,5 lts	1,20	487286	254,00
225	340	5-5,5 lts	1,40	487288	283,00
265	410	10-10,5 lts	1,60	487290	314,00

Balanza mecánica de cocina

Kitchen scales
Balance mécanique de cuisine



Características:

Capacidad: 5 Kg.
Divisiones de 20 en 20 gramos.
Sensibilidad: 20 gramos.

Characteristics:

Capacity: 5 kg.
Divisions every 20 gr.
Sensitivity: 20 gr.

Caractéristiques:

Capacité : 5 Kg.
Divisions de 20 en 20 grammes.
Sensibilité : 20 grammes.

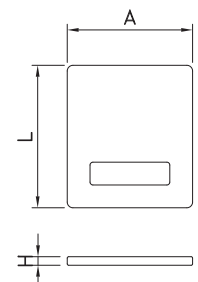

L	A	H			€
220	200	220	1,80	480234	55,00

Balanza de cocina ultra-fina

Kitchen scale slim design
Balance de cuisine ultra-fine



Novedad
New
Nouveau

Características:

Capacidad 5 Kg.
Sensibilidad 1 gr.
Indica el volumen de agua y leche.
Dos sistemas peso, conversor en gr, lb, oz.
Dos sistemas volumen, conversor ml, fl, oz.
Indicador de pila baja y sobrecarga.
Sensor de alta precisión.
Función de tara.
Auto-apagado.

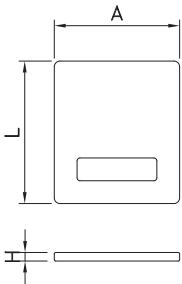

Characteristics:

Capacity: 5 kg.
Sensitivity: 1 gr.
It allows the measurement of water and milk.
Two weighing systems, converter for gr, lb, oz.
Two volume systems, converter for ml, fl, oz.
Low battery and overload indicators.
High precision sensor.
Tare function.
Auto power-off.

Caractéristiques:

Capacité 5 Kg.
Sensibilité 1 gr.
Indique le volume de l'eau et du lait
Deux systèmes de poids, convertisseur en g, lb, oz.
Deux systèmes de volume, convertisseur ml, fl, oz.
Indicateur de pile basse et de surcharge.
Capteur de haute précision.
Fonction de tare.
Arrêt automatique.

L	A	H	Gr	Barcode	€
250	220	15	500	480232	32,00

Rasqueta para vitrocerámicas

Scraper for glass ceramic
Grattoir pour vitrocéramique

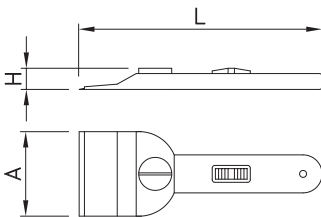

L	A	H	Gr	Barcode	€
135	45	18	100	448110	6,00

Espátula para planchas de cromo-duro

Spatula for chromium plate griddles
Racloir pour plaques chromées

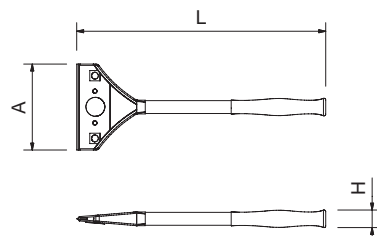

L	A	H	Gr	Barcode	€
290	100	20	348	448102	33,00



Hojas de repuesto en acero inoxidable para espátula plancha de cromoduro.
Stainless steel spare blades for chromium plate griddle spatula.
Lames de rechange pour racloir à plaque chromée.

Barcode	Gr	Barcode	€
---------	----	---------	---

10 50 448104 20,00



Utensilios para pizzería

Pizza making utensils
Ustensiles pour pizzeria

Picador de masa de pizza en acero inox

Pizza dough pitter in stainless steel
Pique pâte à pizza en acier inox

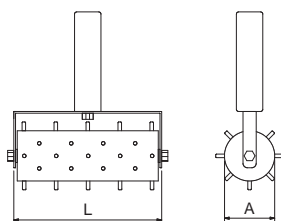

L	A	Gr	Barcode	€
127	44	350	440706	45,00

Pinza para bandeja de horno en acero inox

Clip for baking tray in stainless steel
Pincas pour plaque à four en acier inox



L	A	Gr	Barcode	€
240	90	150	440714	39,00

Cazo para salsa en acero inox

Saucepan in stainless steel
Cuillère à sauce en acier inox

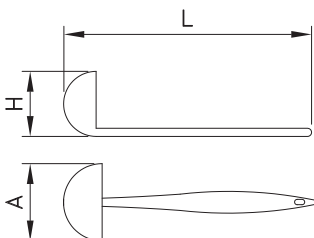

L	A	H	Gr	Barcode	€
350	90	90	150	440712	29,00

Cortadora de masa de pizza

Pizza dough cutter
Coupe pâte à pizza

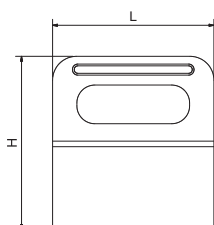

L	H	Gr	Barcode	€
135	145	100	440722	9,00

Bandeja de aluminio con asas para pizza 6 porciones

Pizza aluminium tray with handgrips - 6 slices
Plaque en aluminium avec poignées pour pizza 6 portions

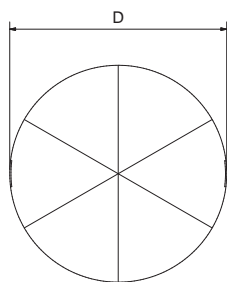

D	Gr		€
450	300	440708	40,00

Bandeja de aluminio con mango para pizza 6 porciones

Pizza aluminium tray with handle - 6 slices
Plaque en aluminium avec manche pour pizza 6 portions

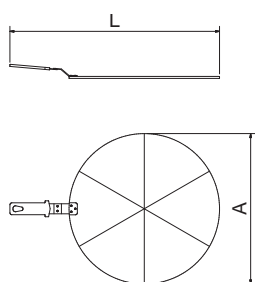

L	A	Gr		€
600	450	320	440710	60,00

Pala redonda de aluminio para horno

Rounded tray baking peel in aluminium
Pelle ronde en aluminium pour four

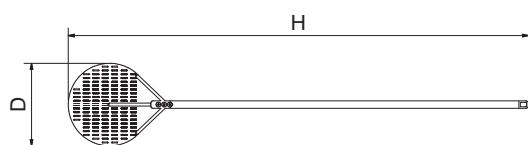

D	H	Gr		€
330	1840	900	440702	139,00

Pala cuadrada de aluminio para horno

Squared tray baking peel in aluminium
Pelle carrée en aluminium pour four

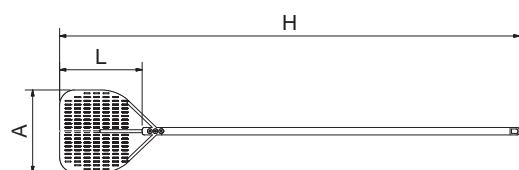

L	A	H	Gr		€
330	330	1840	950	440704	139,00

Paleta oval en acero inox

Oval serving spatula in stainless steel
Pelle ovale en acier inox



Novedad
ew
ouveau

Resistencia hasta 200° C
Heat resistance up to 200° C
Résistance jusqu'à 200° C

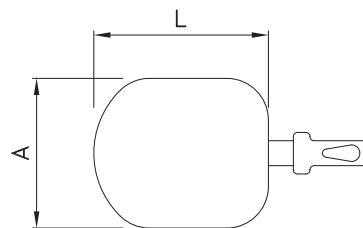

L	A	Gr	Barcode	€
210	180	500	440728	34,00

Paleta oval en acero inox perforada

Oval perforated serving spatula in stainless steel
Pelle ovale perforé en acier inox



Novedad
ew
ouveau

Resistencia hasta 200° C
Heat resistance up to 200° C
Résistance jusqu'à 200° C

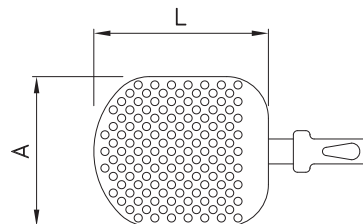

L	A	Gr	Barcode	€
220	180	500	440730	39,00

Paleta redonda aluminio

Rounded tray baking peel in aluminium
Pelle ronde en aluminium pour four



Novedad
ew
ouveau

Resistencia hasta 200° C
Heat resistance up to 200° C
Résistance jusqu'à 200° C

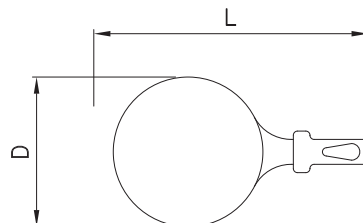

L	D	Gr	Barcode	€
430	280	350	440732	32,00

Cortador de pizza

Pizza cutter
Couteau à pizza

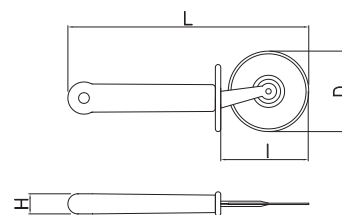

L	H	I	D	Gr	Barcode	€
180	20	70	60	59	446908	15,00

Cortador de pizza profesional

Professional pizza cutter
Coupe pizza professionnel

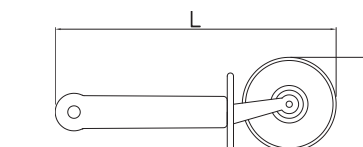

L	D	Gr	Barcode	€
250	100	170	440716	48,00

Paleta para servir pizza en acero inox

Pizza server in stainless steel
Pelle pour servir pizza en acier inox

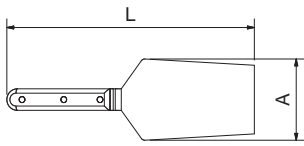

L	A	Gr	Barcode	€
120	75	140	440718	14,00



Espátula para preparación pizza en acero inox

Spatula for pizza in stainless steel
Spatule de préparation pizza en acier inox

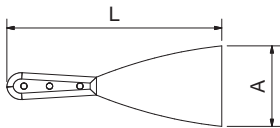

L	A	Gr	Barcode	€
110	100	150	440720	10,30



Bolsa térmica para transporte de pizza

Insulated thermal pizza delivery bag
Sac thermique pour transporter des pizzas

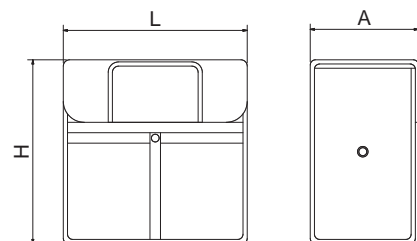

L	A	H	Icons	Gr	Barcode	€
350	200	350	5	500	440724	69,00
420	200	420	4	700	440726	75,00



Bases inoxidables para transporte de pizzas

Stainless pizza pans
Base inox pour transport de pizzas

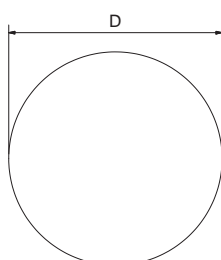

D	G	Kg	Barcode	€
278	1	0,49	042402	10,00
406	1	1,04	042404	15,00





Utensilios para pasteleros

Pastry making utensils
Ustensiles pour pâtissiers

Laminador de tartas

Cake slicer
Laminoir pour tartes

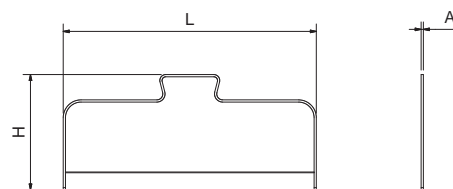

L	A	H	Gr	Barcode	€
340	12	162	158	440304	6,00

Molde para laminar tartas 26/28 cms.

Layer cake slicer for cakes 26/28 cms.
Moule à laminer tarte 26/28 cms.

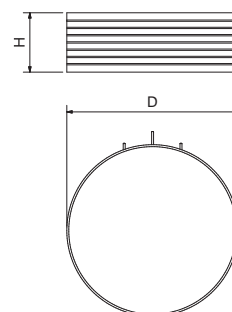

D	H	Gr	Barcode	€
260	90	693	440306	32,00

Pincel de silicona y acero inox
Pastry brush in silicone and stainless steel
Pinceaux en silicone et acier inox

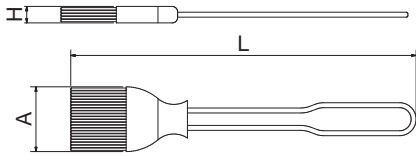

L	A	H	Gr	Barcode	€
200	50	10	48	440312	6,00



Espátula de silicona y acero inox
Spatula in silicone and stainless steel
Spatule en silicone et acier inox

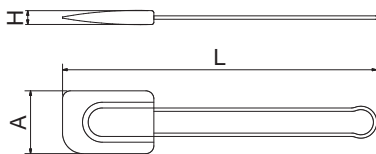

L	A	H	Gr	Barcode	€
280	58	12	89	440310	8,00



Espátula pastelera
Bakery spatula
Spatule à gâteau

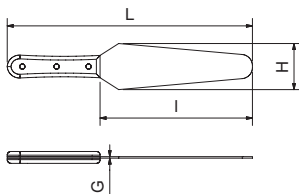

L	I	H	G	Gr	Barcode	€
215	125	26	1,0	65	441402	10,90
255	155	26	1,0	70	441404	12,10
335	205	40	1,0	170	441406	17,10
385	255	45	1,0	190	441408	22,80
440	315	45	1,5	205	441410	28,80
490	365	45	1,5	265	441412	34,10



Conjunto de conos para relleno de crema en acero inox
Stuffing horn set in stainless steel
Set de moules cornets pour garniture de crème en acier inox

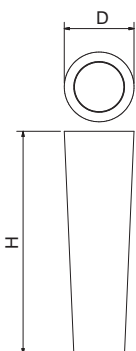

H	D	Gr	Barcode	€
65	16	5	122 440302	6,00
135	22	2		



Pala para tartas / pizza en acero inox

Cake / pizza server in stainless steel
Pelle à tarte /pizza en acier inox

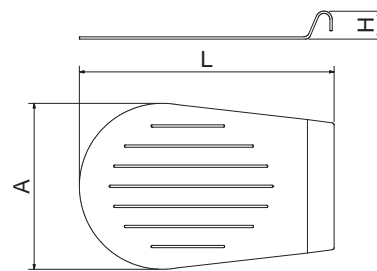

L	A	H	Gr	Barcode	€
430	290	20	356	440314	19,00

Tamizador en acero inox

Sifter in stainless steel
Tamis en acier inox

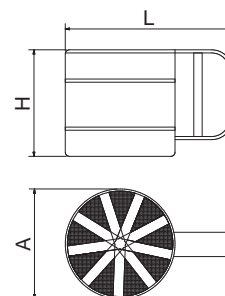

L	A	H	Gr	Barcode	€
160	105	102	195	440316	17,00

Jarra medidora con fondo antideslizante 1 lt.

Measuring jug 1 liter with non-slip bottom
Verre doseur avec fond antidérapant 1 litre

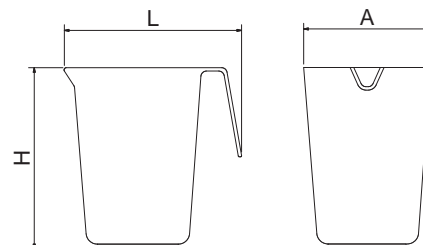

L	A	H	Gr	Barcode	€
112	145	160	160	440308	11,00

Máquina para hacer churros y pastas

Churros and cookies machine
Appareil à churros et pâtisserie

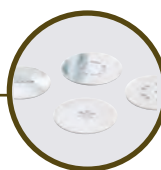

447910 € 4,00

Discos de respuesto para máquina de hacer churros y pastas
Spare discs for pastry and churros maker

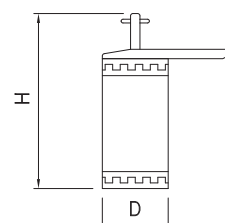

D	H	Gr	Barcode	€
70	150	530	447908	31,00





Servicio de mesa y barra
 Table and bar service
 Service de table et comptoir

Porta brochetas
 Skewer holder
 Porte-brochettes

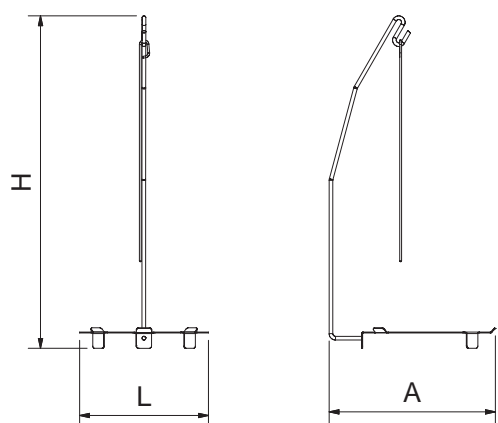

L	A	H	Kg	Barcode	€
210	270	540	1,00	040230	35,00

Pinchos brocheta
 Kebab sticks
 Brochettes

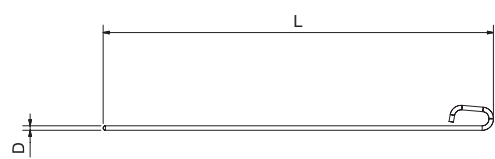

Precio y peso por unidad.
 Unit price and weight.
 Prix et poids unitaire.

L	D	Gr	Bolsa Bag Sac	Barcode	€
261	3	15	10	040208	1,00
311	3	20	10	040210	1,20
361	3	25	10	040212	1,30

Cuencos

Bowls
Bols



Novedad
ew
ouveau

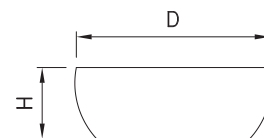

D	H	lit	Gr	Barcode	€
140	50	0,6	99	483210	3,00
190	70	1,5	155	483212	4,00
240	90	3,0	267	483214	5,00

Cuencos para salsas

Sauce bowl
Bol à sauce

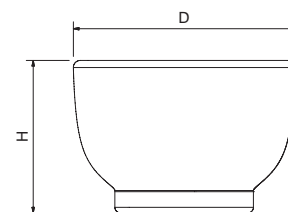

D	H	Color	Gr	Barcode	€
98	50	Red	300	434424	9,00
98	50	White	300	434426	9,00
98	50	Yellow	300	434428	9,00
98	50	Green	300	434430	9,00

Bowls en policarbonato transparente

Bowls in transparent polycarbonate
Bols en polycarbonate transparent

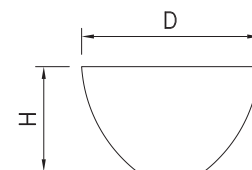

D	H	Gr	Barcode	€
120	74	115	483202	2,50
217	128	200	483204	6,00
282	174	290	483206	13,00

Fibras chuletón rectangulares

Rectangular fibre steak-boards
Fibres côtes de bœuf rectangulaires

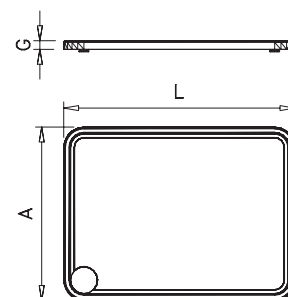

L	A	G	Kg	€	Barcode	Barcode
300	200	15	0,9	16,00	432202	432302
400	200	15	1,2	19,00	432204	432304
400	300	15	1,8	24,00	432206	432306
300	200	20	1,2	19,00	432208	432308
400	200	20	1,6	23,00	432210	432310

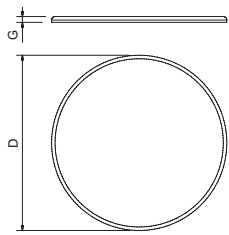

D	G	Gr	434436	€
300	10	900	434436	12,00

Plato de presentación
Presentation plate
Assiette de présentation

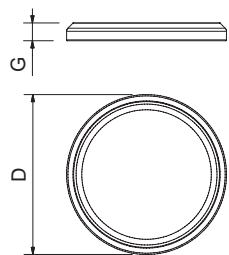

D	G	Gr	434434	€
180	20	648	434434	13,00

Plato de presentación especial pulpo
Octopus presentation plate
Assiette de présentation poulpe

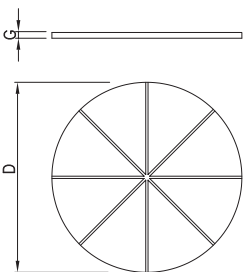

D	G	Kg	434438	€
300	10	1,0	434438	15,20

Plato pizza
Pizza plate
Assiette de pizza

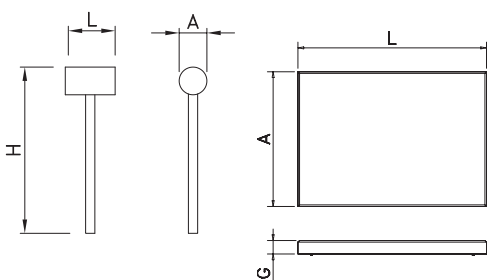

L	A	G	H	Gr	434466	€
100	100	15		200	434466	8,00
70	30		180			

Conjunto rompe marisco
Cracker hammer seafood set
Set à fruits de mer



Plato de cocktail

Cocktail plate
Assiette de cocktail

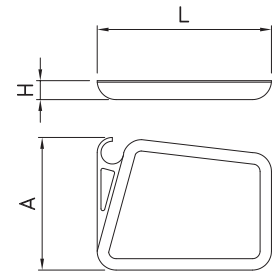

L	A	H	Gr	Barcode	€
230	175	20	80	480650	1,20

Plato cuatro salsas

French fries dish 4 sauces
Plat a frites 4 sauces

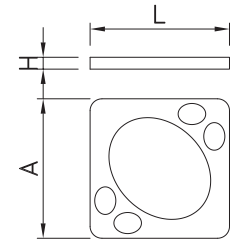

L	A	H	Gr	Barcode	€
235	235	20	199	480654	6,00

Salsera circular 6 salsas

Round polyethylene serving board for 6 sauces
Planche polyéthylène ronde à 6 sauces

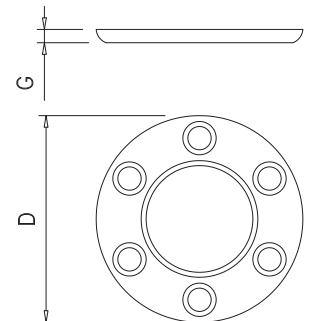

D	G	Gr	Barcode	€
330	20	500	434420 434422	32,00

Salsera 8 salsas

Oval polyethylene serving board for 8 sauces
Planche polyéthylène ovale à 8 sauces

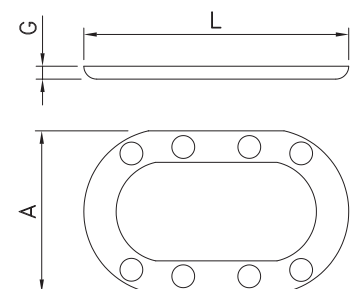

L	A	G	Kg	Barcode	€
410	250	20	1,70	434414	39,00

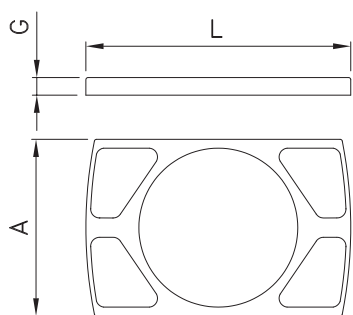

L	A	G	Kg	Barcode	€
300	200	20	1,00	434416	26,00



Salsera rectangular 4 salsas

Rectangular polyethylene serving board for 4 sauces
Planche polyéthylène rectangulaire à 4 sauces

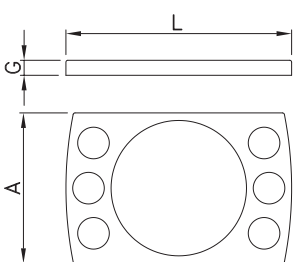

L	A	G	Kg	Barcode	€
300	200	20	1,00	434418	26,00



Salsera rectangular 6 salsas

Rectangular polyethylene serving board for 6 sauces
Planche polyéthylène rectangulaire à 6 sauces

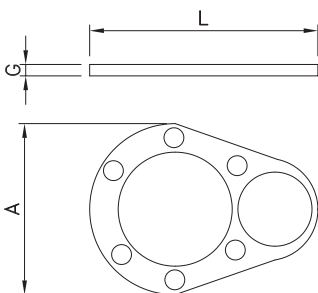

L	A	G	Kg	Barcode	€
440	300	20	2,20	434412	41,00



Salseras de diseño 6 salsas

Serving boards desing for 6 sauces
Planche en polyéthylène à 6 sauces modèle design

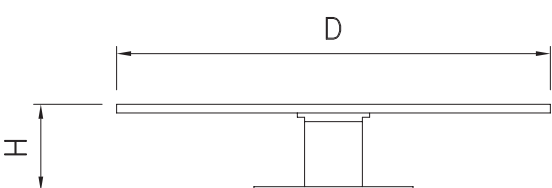

D	H	Gr	Barcode	€
300	60	500	480656	25,00

Plato giratorio de cristal

Rotating glass plate
Assiette en verre tournante

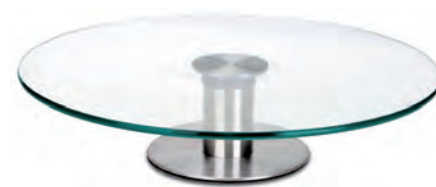

Plato giratorio

Rotating plate
Assiette tournante

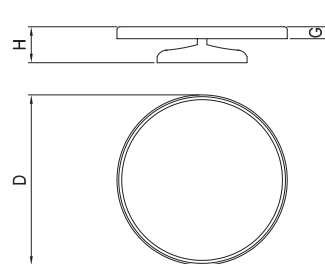

D	G	Kg	Barcode	€
285	20	1,30	434437	41,00

Bandeja para platos fríos

Cold plate for dishes
Plateau pour plats froids



Características:

Se guarda en el congelador un mínimo de 4h. Mantiene el frío durante bastante tiempo, lo que permite una presentación higiénica de los alimentos.

Characteristics:

It must be kept in the freezer for 4 hours. It keeps cold for quite long time, for a hygienical presentation of food.

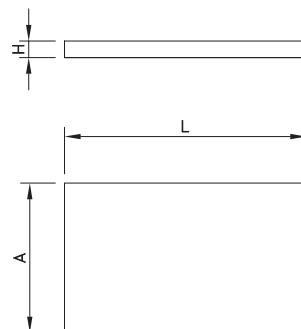

L	A	H	Kg	Barcode	€
525	325	36	3,7	476094	191,00

Caractéristiques:

Il faut le mettre au congélateur un minimum de 4 heures. Maintient au froid durant assez longtemps, ce qui permet une présentation hygiénique des aliments.

Cesta rectangular

Rectangular wire basket
Panier rectangulaire

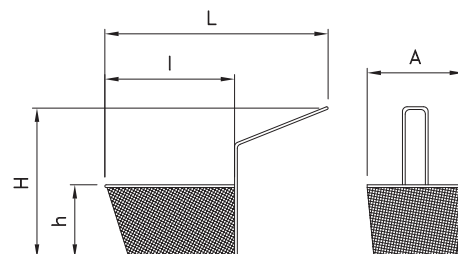

L	A	H	I	h	Gr	Barcode	€
240	105	165	140	80	160	480602	15,00

Cesta redonda

Round wire basket
Panier Rond

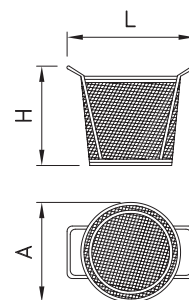

L	A	H	Gr	Barcode	€
120	95	90	125	480604	13,00

Vaso en policarbonato
 Polycarbonate glass
 Verre polycarbonate

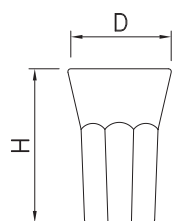

D	H	cl	Gr	Barcode	€
80	88	27 cl.	60	483260	1,20
90	106	40 cl.	80	483262	1,30
90	132	50 cl.	105	483264	1,50

Copa en policarbonato
 Polycarbonate cup
 Tasse polycarbonate

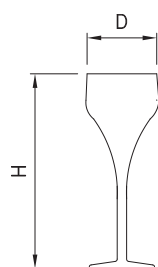

D	H	cl	Gr	Barcode	€
74	207	18 cl.	85	483250	3,20

Jarra de agua
 Water jug
 Pichet

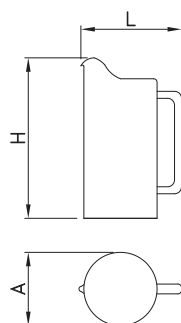

L	A	H	lit	Gr	Barcode	€
230	105	230	1,8	100	483254	8,00

Tenedor de mesa
 Table fork
 Fourchette de table

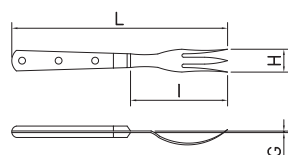

L	I	H	G	Gr	Barcode	€
190	86	23,4	1,44	53	440126	10,60

Cuchara de mesa

Table spoon
Cuillère à soupe

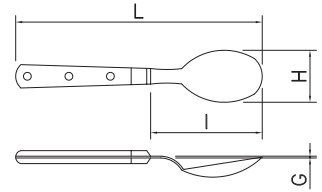

L	I	H	G	Gr	Barcode	€
192	87,10	41,04	1,33	72	440128	13,60

Cuchillo de mesa modelo chuletero

Steak table knife
Couteau de table modèle pour côtelette

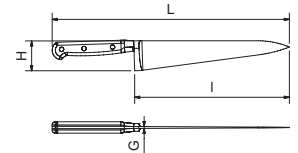

L	I	H	G	Gr	Barcode	€
223	112	20	1,78	70	440120	10,90

Cuchillo de mesa corte liso

Table knife, smooth cut blade
Couteau de table bord lisse

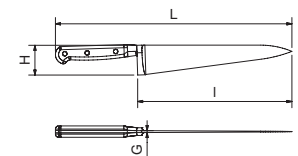

L	I	H	G	Gr	Barcode	€
216	112	20	1,36	62	440124	10,90

Cuchillo de mesa modelo chuletón

Ribeye steak table knife
Couteau de table modèle pour steak

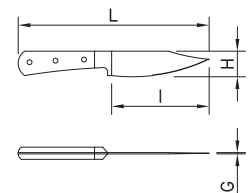

L	I	H	G	Gr	Barcode	€
235	120	28	1,74	88	440122	15,10

Tenazas quita espinas

Fish pliers
Pincettes à poissons

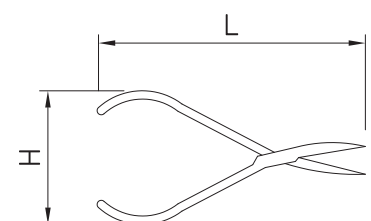

L	H	Gr	Barcode	€
160	80	160	440054	27,00

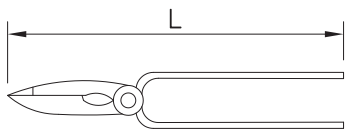

L	Gr		€
160	130	440018	19,00

Corta mariscos forjado

Forged shellfish cracker
Pince à crustacés

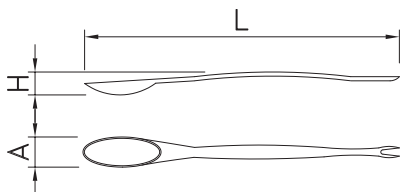

L	H	A	Gr		€
230	3	30	180	440056	5,00

Tenedor marisco

Seafood fork
Fourchette à crustacés

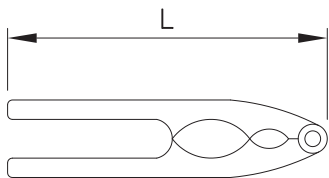

L	Gr		€
160	220	440026	17,40

Cascanueces

Nutcracker
Casse-noix

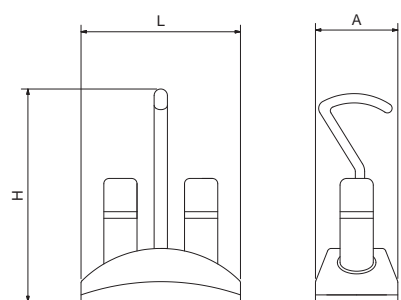

L	A	H	Gr		€
120	45	160	230	440050	11,00

Conjunto sal y pimienta

Salt and pepper set
Set poivrière et salière

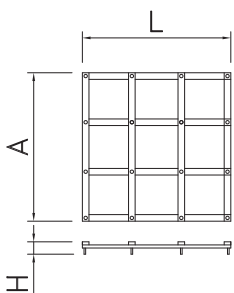

L	A	H	Gr		€
360	360	15	250	440908	16,00

Salvamantel extensible

Extending tablemat
Dessous de plat extensible

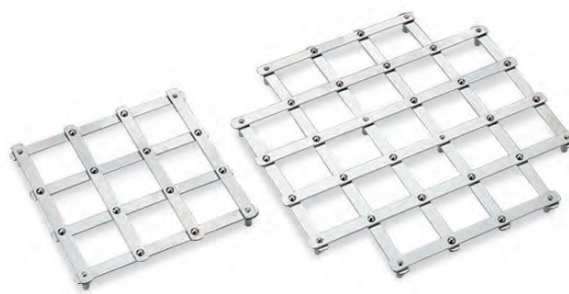



Barman
Barman
Barman

Sacacorcho navaja

Corkscrew pocketknife
Tire-bouchon canif

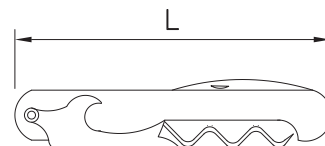

L	Gr	Barcode	€
110	72	440022	6,00

Sacacorcho Tirolés

Corkscrew
Tire-bouchon

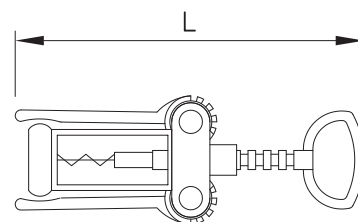

L	Gr	Barcode	€
170	131	440024	6,40

Abrebotellas

Bottle opener
Ouvreur de bouteille

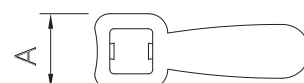
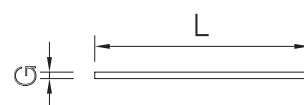

L	A	G	Gr	Barcode	€
100	35	3	180	440044	1,80

Sacacorchos mural
Wall-mounted corkscrew
Tire-bouchon mural

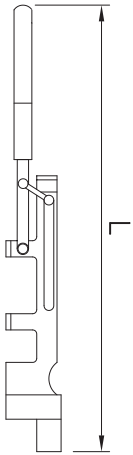

L	Kg	€
550	2,52	483416 225,00



Sacacorchos eléctrico
Electric corkscrew
Tire-bouchon électrique

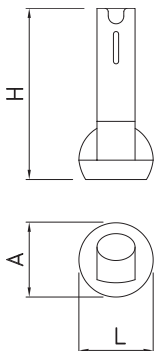

L	A	H	Tensión Voltage Tension	Potencia Power Puissance	Gr	€
115	115	265	3,6 V	600 mA	800	483428 105,00



Batería Ni-MH.
Sujeción de acero inox.
Con indicador que muestra la batería que le queda.
LED azul para mostrar cuando se está usando o cargando.
LED rojo para cuando se libera el corcho.
Hecho en España.

Ni-MH Battery
Stainless steel holder
A led indicator shows the remaining power
A blue led indicates that it is in use or charging
A red led indicates that the cork has been released
Made in Spain

Batterie Ni-MH.
Fixation en acier inoxydable.
Avec indicateur montrant la batterie qu'il vous reste.
LED bleue pour afficher lorsque vous l'utilisez ou le chargez.
LED rouge lorsque le bouchon est libéré.
Fabriqué en Espagne.

Tapón inox
Stainless steel stopper
Bouchon inox

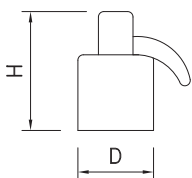

D	H	Gr	€
35	80	5,5	483430 25,00

Tapón de cierre hermético para mantener el vino fresco durante más tiempo.
Fácil manejo.

Hermetic stopper, for a fresher wine for longer.
Easy to use.

Bouchon de fermeture hermétique pour maintenir le vin frais durant plus de temps.
Usage facile.



Tapón de corona acero inox

Bottle crown cap in stainless steel
Capsule couronne acier inox

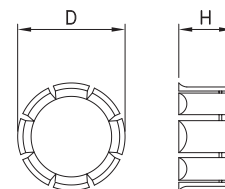

D	H	Gr	Barcode	€
40	20	5	483418	1,00

Tapón vertedor cromado (2 uds.)

Chromed pourer cap (2 pieces)
Bouchon verseur chromé (2 pièces)

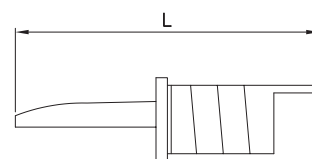

L	Gr	Barcode	€
80	47,25	483420	4,00

Tapón hermético acero inox (2 uds.)

Sealing plug (2 pieces)
Bouchon hermétique acier inox (2 pièces)

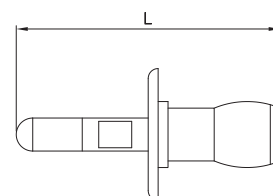

L	Gr	Barcode	€
80	44,16	483422	4,20

Tapón cava cromado

Chromed stopper for sparkling wine
Bouchon pour bouteille de champagne chromé

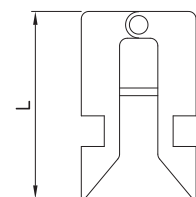

L	Gr	Barcode	€
50	89,66	483424	8,00

Anillo acero inox antigoteo para botella de vino
 Wine drip collar in stainless steel
 Anneau de chute acier inox anti-gouttes pour bouteille de vin

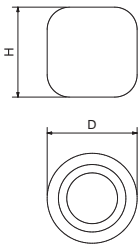

D	H	Gr	Barcode	€
40	40	10	483408	2,00



Bomba de vacío para botella de vino
 Wine bottle vacuum pump
 Tire-bouchon à air pour bouteille de vin



Barcode	€
483432	6,00

Juego de dos tapones de repuesto para bomba vacío
 2 Wine Stoppers for Vacuum pump
 2 Bouchons de vin pour Pompe vide d'air

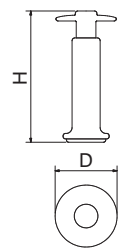

D	H	Gr	Barcode	€
50	140	10	483410	13,00

Oxigenador de vino
 Wine aerator
 Oxygénateur de vin

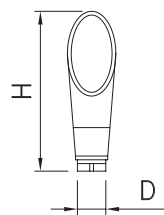

D	H	Gr	Barcode	€
38	102	45	483412	16,00



Escanciador de vino
 Wine pourer
 Verseur

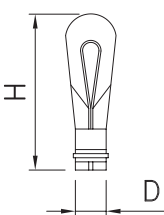

D	H	Gr	Barcode	€
15	76	16	483426	5,20

Novedad
 ew
 ouveau



Termómetro digital para botella de vino

Wine bottle digital thermometer
Thermomètre digital pour bouteille de vin



Para controlar la temperatura del vino sin abrir la botella.

Se puede usar en la nevera o refrigerador
Lectura de temperatura instantánea con intervalos de 1°C.

Para botellas de hasta 100 mm. de diámetro.

Pour contrôler la température du vin sans ouvrir la bouteille.

Il peut être utilisé dans la glacière ou réfrigérateur
Lecture de la température instantanée à des intervalles de 1°C.

Pour les bouteilles jusqu'à 100 mm. de diamètre.

To check the wine temperature without opening the bottle.

It can be used in the fridge or in the ice chest.
Instant display of temperature with intervals of 1°C.

For bottles up to 100 mm. diameter.

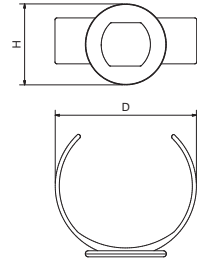

D	H	Gr	Barcode	€
40	70	22	483414	16,00

Coctelera

Shaker
Shaker

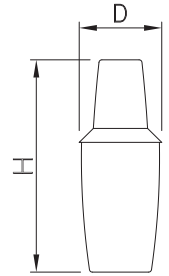

D	H	Gr	Barcode	€
70	180	200	440058	16,00

Pala para hielo en acero inox

Stainless steel ice shovel
Pelle à glaçons en acier inoxydable

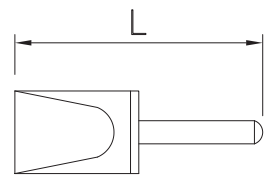

L	Gr	Barcode	€
150	500	474457	21,00

Pinza para cubitos de hielo

Ice tongs
Pincas à glace

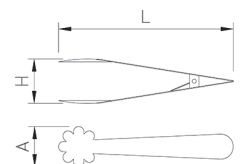

L	A	H	Gr	Barcode	€
185	35	50	100	440008	3,30

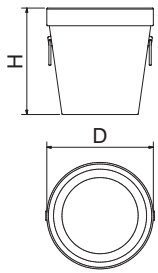

D	H	lit	Gr	Barcode	€
200	200	3.8	442	483404	31,00

Champanera acero inox
 Champagne cooler bucket in stainless steel
 Seau à Champagne acier inox

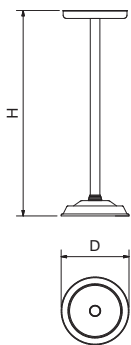

D	H	Kg	Barcode	€
250	750	4,50	483406	121,00

Pie de champanera
 Champagne cooler stand
 Pied pour seau à champagne

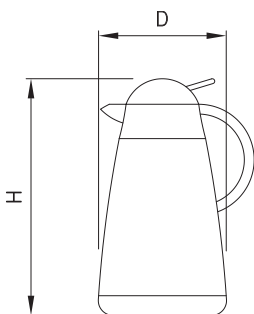

D	H	lit	Gr	Barcode	€
130	290	2	811	480244	37,00

Termo
 Thermos flusk jug
 Thermos

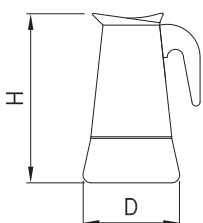

D	H	Cup	lit	Gr	Barcode	€
120	210	8	1	818	480240	30,00

Cafetera express inox
 Express coffee pot
 Cafetière express inox





LAVAMANOS

Hand wash basins
Lave-mains

NOVEDADES

News
Nouveautés

Lavamanos registrable autónomo eléctrico un pulsador agua fría One push button free standing self-contained mobile electrical hand wash- basin Lave-mains autonome électrique avec poussoir.....	177
Lavamanos portátil autónomo automático de doble pulsador, agua fría y caliente Automatic self-contained mobile hand-sink, 2 push button for cold & hot water Lave-main aut. sur pied autonome et por table.2 poussoirs d'eau froide et chaude	177
Conjunto peto, jabonera y dispensador Raised backsplash for mobile hand washbasin Dossieret inox postérieur pour lave-mains autonome	178
Lavamanos registrable portátil autónomo grandes eventos Mobile hand washbasin with self-contained free standing system for large events Lave-mains autonome registrable portable grands évènements	192





Main characteristics:

Self-contained hand washbasins main characteristics:
 Fully constructed of stainless steel
 Self-contained system which makes unnecessary any water inlet or drainpipe.
 This system works by pumping clean water from one of the interior 10 litre tanks, whereas the dirty water is poured into the other 10 litre tank. It is provided of anti odour system.
 Rear handle and back wheels that make easier to move it around.
 Large capacity top sink with front rounded corners, heavy duty fabrication. It is provided with anti-drip edges.
 The frame is closed on three sides, with interior shelf and front detachable door.
 Discrete wastepaper bin built in the unit. Easy access to the wastepaper bin through a swing lid.
 Anti-splash panel installed.
 Battery working automatic soap dispenser 1lt.
 Tissue dispenser. The casing allows the placing of standard boxes with tissues, globes, shoe covers, face masks, etc.

Caractéristiques principales des lave-mains autonomes:

Fabriqué entièrement en acier inoxydable.
 système autonome il ne requiert pas de prise d'eau d'entrée ni déversoir.
 Il fonctionne avec un poussoir hydraulique qui pompe l'eau d'un réservoir de 10 litres situé à l'intérieur du lave-mains. L'autre réservoir est pour l'eau sale.. Il dispose d'un système anti-odeur.
 Il est pourvu d'une poignée postérieure et de roulettes pour mieux le déplacer.
 Le bac a les arêtes frontales arrondies, ce qui favorise la résistance. Le bac a aussi un rebord pour éviter les chutes d'eau.
 L'armoire est fermée par les trois cotés, avec étagère inférieure et porte frontale.
 Poubelle intégrée dans l'armoire usage facile et discret, accès à la poubelle avec trappe basculante.



Esquinas redondeadas
 Rounded corners
 Coins arrondis

Características principales de lavamanos autónomos:

Totalmente construido en acero inoxidable.
 Sistema autónomo que no precisa instalación de tomas de agua, desagüe.
 Este sistema funciona bombeando el agua limpia desde uno de los depósitos situado en su interior, el otro es para el agua sucia. Dispone de sistema anti-olores.
 Con asa de arrastre posterior y ruedas para su fácil transporte.
 Cubeta con aristas frontales redondeadas, de gran dimensión y alta resistencia, provista de reborde anti-derrames.
 Armario cerrado por tres lados, con estante interior y puerta frontal.
 Papelera integrada dentro del mueble. Cómodo y discreto acceso a papelera mediante trampilla basculante.

Video



Ideal para lugares donde:
 No hay tomas de agua.
 No hay desagüe.
 No hay instalación eléctrica.

Perfecto para eventos al aire libre, clínicas, ferias, exposiciones, mercados, etc.

Ideal for places where:
 There are no water installation
 There are no drain installation
 There are no electrical installation

Perfect for outdoor events, clinics, fairs, exhibitions, markets, etc.

Il est conçu spécialement pour des places où:
 Il n'y a pas de prises d'eau.
 Il n'y a pas de déversoirs.
 Il n'y a pas de courante électrique.



Parfait pour des événements en plein air, cliniques, foires, expositions, marchés ambulants...



Comparativa lavamanos autónomos
Comparison chart on self-contained washbasins
Comparaison de lave-mains autonomes

061428

061430

061468 061466 061474 

Características
Feature
Caractéristiques



Tipo de accionamiento Operation Accionnement	Pulsador hidráulico tipo pedal Pedal type hydraulic push button Poussoir hydraulique type pédale	Pulsador hidráulico tipo bomba Pump type hydraulic push button Poussoir hydraulique type pompe	Pulsador accionamiento automático Automatic operation push button Poussoir accionnement automatique	Pulsador accionamiento automático Automatic operation push button Poussoir accionnement automatique	Pulsador hidráulico tipo pedal Pedal type hydraulic push button Poussoir hydraulique type pédale
Caudal Flow Débit	2 l/min	1 l/min	3,8 l/min	3,8 l/min	2 l/min
Requiere toma eléctrica Electrical outlet required Requiert prise d'électricité	----	----	<input checked="" type="checkbox"/>	<input checked="" type="checkbox"/>	----
Agua fría Cold water Eau froide	<input checked="" type="checkbox"/>	<input checked="" type="checkbox"/>	<input checked="" type="checkbox"/>	<input checked="" type="checkbox"/>	<input checked="" type="checkbox"/>
Agua caliente Hot water Eau chaude	Opcional Optional Optionnel	Opcional Optional Optionnel	Opcional Optional Optionnel	<input checked="" type="checkbox"/>	Opcional Optional Optionnel
Potencia Power Puissance	----	----	19 W	4400 W	----
Calentador Heater Chauffe eau	----	----	----	<input checked="" type="checkbox"/>	----
Admite calentadores Heaters supported Chauffe eau peut être ajouté	061450 061452 061454	061450 061452 061454	061450 061452 061454 461456	Incluido Included Inclus	061450 061452 061454
Admite conexión a red de agua Water inlet supported Peut se connecter au réseau d'eau	----	----	<input checked="" type="checkbox"/>	<input checked="" type="checkbox"/>	----
Caño giratorio Rotating spout Bec tournant de robinet commande	<input checked="" type="checkbox"/>	<input checked="" type="checkbox"/>	<input checked="" type="checkbox"/>	<input checked="" type="checkbox"/>	<input checked="" type="checkbox"/>
Peto trasero Backsplash Dossieret inox	<input checked="" type="checkbox"/>	<input checked="" type="checkbox"/>	<input checked="" type="checkbox"/>	<input checked="" type="checkbox"/>	<input checked="" type="checkbox"/>
Peto para lavamanos autónomo, jabonera y dispensador de tissues, guantes, etc Raised backsplash for mobile hand washbasin, soap dispenser, gloves dispenser, etc Dossieret inox postérieur pour Lave-mains autonome, Distributeur de savon, dispen	Opcional Optional Optionnel	Opcional Optional Optionnel	Opcional Optional Optionnel	Opcional Optional Optionnel	----
Papelera en el interior	<input checked="" type="checkbox"/>	<input checked="" type="checkbox"/>	<input checked="" type="checkbox"/>	<input checked="" type="checkbox"/>	----
Largo Lenght Longueur	450 mm.	450 mm.	450 mm.	450 mm.	800 mm.
Ancho Width Largeur	450 mm.	450 mm.	450 mm.	450 mm.	500 mm.
Alto Height Hauteur	850 mm.	850 mm.	850 mm.	850 mm.	850 mm.
Tipo de cubeta Type of bowl Type d'évier	Redonda con reborde Rounded with anti-drip edge Arrondi avec rebord	Redonda con reborde Rounded with anti-drip edge Arrondi avec rebord	Redonda con reborde Rounded with anti-drip edge Arrondi avec rebord	Redonda con reborde Rounded with anti-drip edge Arrondi avec rebord	Rectangular Rectangular Rectangulaire
Dimensiones cubeta Bowl dimensions Dimensions évier	Ø 390 mm.	Ø 390 mm.	Ø 390 mm.	Ø 390 mm.	340x370 mm.
Profundidad cubeta Bowl depth Profondeur évier	150 mm.	150 mm.	150 mm.	150 mm.	150 mm.
Bidones incluidos Plastic tanks included Bidons inclus	2	2	2	2	4
Capacidad agua limpia Clean water tank capacity Capacité eau propre	10 l.	10 l.	10 l.	10 l.	40 l.
Capacidad agua sucia Dirty water tank capacity Capacité eau sale	10 l.	10 l.	10 l.	10 l.	40 l.
	690€	630€	690€	1.180€	1.430€

Lavamanos portátil autónomo

Free standing self-contained mobile hand washbasin
Lave-mains sur pied autonome et portable



Inc

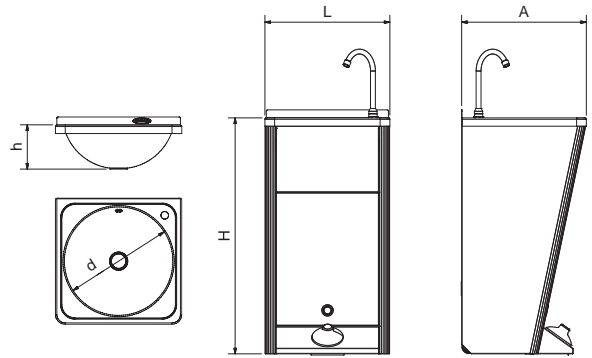

Inc Includo / Included / Inclus
Opcional / Optional / Optionnel

L	A	H	d	h	Kg	lit/min	Barcode	€
450	450	850	390	150	15	1	061430	630,00

Lavamanos portátil gran caudal

Free standing self-contained mobile hand washbasin, high low
Lave-mains sur pied autonome et portable d'grand débit



Inc



Video

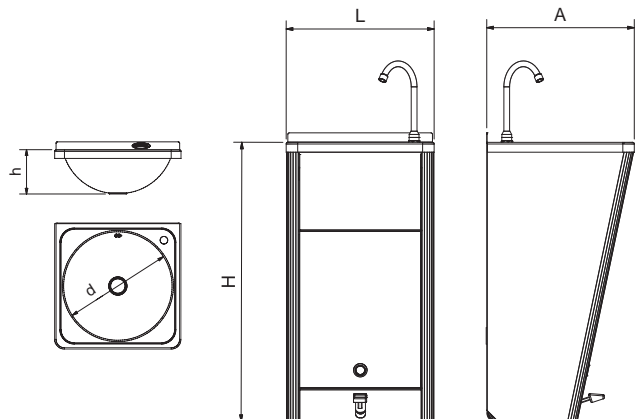

Inc Includo / Included / Inclus
Opcional / Optional / Optionnel

L	A	H	d	h	Kg	lit/min	Barcode	€
450	450	850	390	150	15	2	061428	690,00

Lavamanos registrable autónomo eléctrico un pulsador agua fría

One push button free standing self-contained mobile electrical hand washbasin for cold water
Lave-mains autonome électrique avec poussoir d'eau froide



Necesita conexión eléctrica
Power connection is required
Connexion électrique nécessaire

Video



Inc

Novedad
Nouvel
nouveau

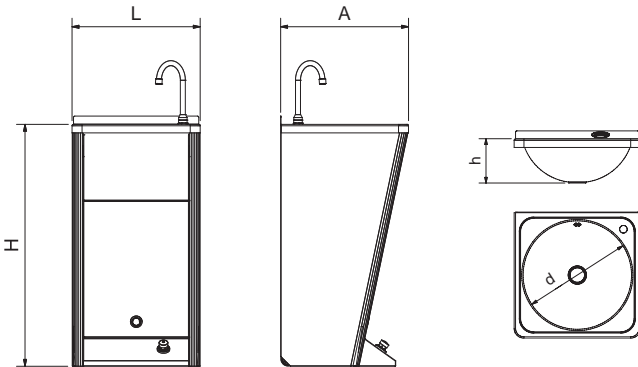

L	A	H	d	h	Potencia Power Puissance	Tensión Voltage Tension	Frecuencia Frequency Fréquence	Kg	litros/l	Barcode	€
450	450	850	390	150	60 W	230	50 Hz	18	3,8	061468	690,00

Inc Incluido / Included / Inclus

Op Opcional / Optional / Optionnel

Lavamanos portátil autónomo automático doble pulsador, agua fría y caliente

Automatic self-contained mobile hand-sink, 2 push button for cold & hot water
Lave-main aut. sur pied autonome et por table, 2 poussoirs d'eau froide et chaude



Necesita conexión eléctrica
Power connection is required
Connexion électrique nécessaire



Inc

Novedad
Nouvel
nouveau

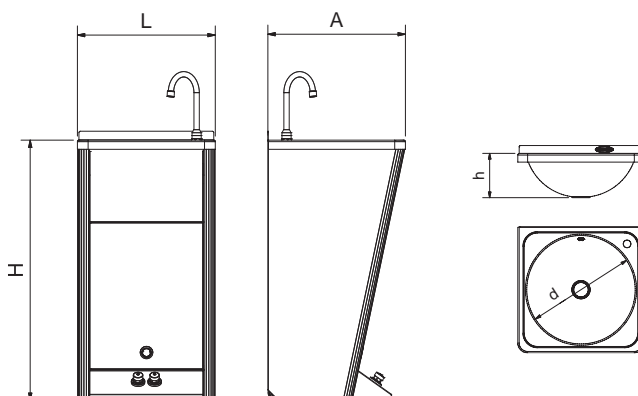

Video



L	A	H	d	h	Temp. Max. °C	Potencia Power Puissance	Tensión Voltage Tension	Frecuencia Frequency Fréquence	Kg	litros/l	Barcode	€
450	450	850	390	150	50°	4.400 W	230	50 Hz	20,50	3,8	061466	1.180,00

Inc Incluido / Included / Inclus

Op Opcional / Optional / Optionnel

Accesorios para lavamanos portátiles autónomos

Mobile and autonomous hand wash basins accessories

Accessoires pour lave-mains sur pied autonome et portable



Opción de agua caliente para lavamanos autónomo
Optional hot water for mobile washbasin
Eau chaude optionnelle pour lave-mains portables

°C °XELU	Potencia Power Puissance	Tensión Voltage Tension	Frecuencia Frequency Fréquence	Modelos Models Modèles	Barcode	€
34°C	100 W	220 V	50/60 Hz	061428 061430 061468 061474	061450	42,00
34°C	100 W	12 V		061428 061430 061468 061474	061452	145,00
34°C	200 W	220 V	50/60 Hz	061428 061430 061468 061474	061454	79,00
50°C	4.400 W	230 V	50/60 Hz	061468	461456	251,00

❄️ Kit para temperatura ambiente inferior a 15 °C.
Accessory for room temperature below 15 °C.
Kit pour température ambiante moins de 15 °C.

Conjunto peto, jabonera y dispensador

Raised backsplash for mobile hand washbasin

Dosseret inox postérieur pour lave-mains autonome

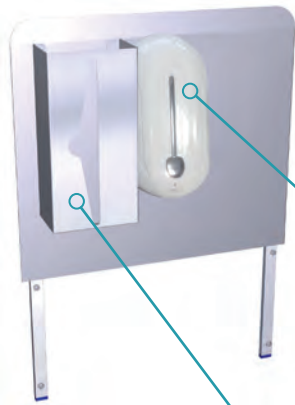

Barcode 460236 399 Inc

Jabonera electrónica (funcionamiento a pilas)
Hands-free soap dispenser (battery working)
Doseur de savon automatique (à piles)

Novedad
Nouveau

Barcode 080418 383 Inc

Dispensador de tissues, guantes, toallas, etc.
Tissues, towels, gloves dispenser
Dispensateur de tissues, essuie-mains, gants, etc.

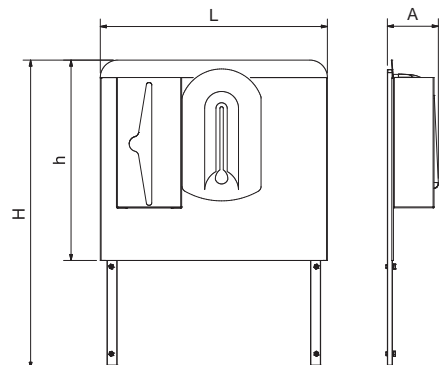

L	A	H	h	Kg	Barcode	€
453	102	615	400	3	060610	120,00

Lavamanos registrable serie XS

Hand wash basin XS model with removable door
Lave-main modèle XS avec porte amovible

La serie de lavamanos XS

Por sus reducidas dimensiones está diseñada para adaptarse a las instalaciones con poco espacio. Su funcionalidad es perfecta, a pesar de su pequeño tamaño, pues incorporamos una nueva cubeta de alto espesor y gran capacidad con reborde antiderrames que asegura su utilidad.

Construidos en acero inoxidable acabado esmerilado Scotch-brite, disponen de una válvula mezcladora antiretorno con la que podrá regular la temperatura de servicio. Cuenta con una papelera incorporada en el mueble.

The range of hand wash basins XS

It is designed to fit up areas with little room because of its reduced dimensions. Although its small size, it is functionally perfect, since it has a new tank of large capacity, and anti-overflow rim, which ensure its usefulness.

It is made of stainless steel emery polished with scotch-brite finishing. They have a non return mixing valve that will allow you to regulate the temperature. It has a wastepaper bin in the piece of furniture.

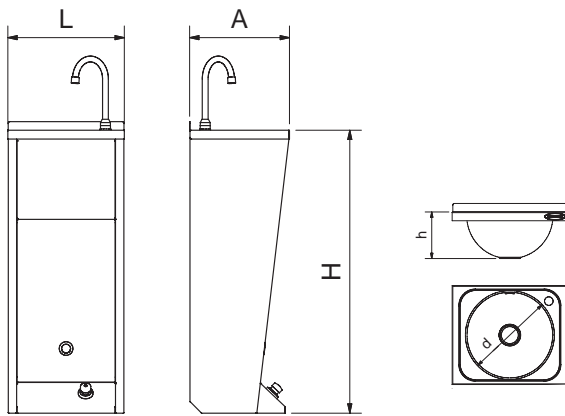

L	A	H	d	h	Kg	Barcode	€
350	300	850	260	115	9	061426	296,00

Les modèles de lave-mains XS

Sont conçus pour s'adapter aux installations où on dispose de peu d'espace. Sa fonctionnalité c'est parfaite, puisqu'il a un nouveau bac à grande capacité, et rebord pour éviter des trop-pleins.

Construit en acier inoxydable poli à l'émeri avec finition Scotch-brite. Il a une valve mélangeuse anti-retour qui permet régler la température. A une corbeille à papier dans le meuble.



Provisto de mezclador antirretorno
Supplied with no-return mixing valve
Munies de valve antiretour mélangeuse

- Includo / Included / Inclus
- Opcional / Optional / Optionnel

Lavamanos de columna electrónico de agua fría y caliente

Electronically-operated hot and cold-water column hand wash basin
Lave-mains de colonne électronique à eau froide et chaude

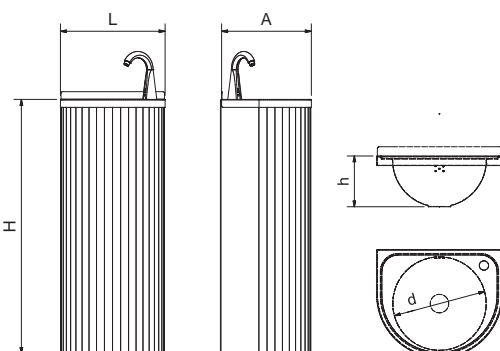

L	A	H	d	h	Kg	Barcode	€
350	300	850	260	115	7	061462	495,00



Provisto de mezclador antirretorno
Supplied with no-return mixing valve
Munies de valve antiretour mélangeuse

Funcionamiento a pilas
Batteries functioning
Fonctionnement a piles



Lavamanos registrable con pedestal un pulsador agua fría y caliente

One push – button hand wash basin, cold and hot water
Lave-mains avec piédestal, un poussoir, d'eau froide et chaude



Provisto de mezclador antirretorno
Supplied with no-return mixing valve
Munies de valve antiretour mélangeuse

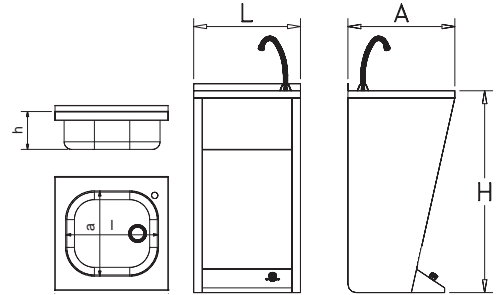

L	A	H	l	a	h	Kg	Barcode	€
450	450	850	370	340	150	12	061012	299,00

Lavamanos integral registrable pulsador de pie

Integral hand wash basin with removable door foot push button
Lave-mains intégral avec porte amovible poussoir à pied



Inc

Dotación de serie:

Lavamanos completo, agua fría y caliente.
Papelerera integrada en el mueble.
Peto trasero.
Dispensador de toallas en acero inoxidable.
Dispensador de jabón en acero inoxidable capacidad 1,2 litros.

Equipment and fittings included:
Fully equipped hand wash basin, hot and cold water.
Wastepaper bin incorporated into the unit.
Backsplash.
Towel dispenser in stainless steel.
Soap dispenser in stainless steel - capacity 1,2 litres.

Équipement et accessoires inclus:
Lave-mains complet, à l'eau froide et chaude.
Corbeille à papier incorporé.
Cuirasse postérieure.
Dispensateur d'essuie-mains en acier inoxydable.
Doseur de savon en acier inoxydable – capacité 1,2 litres.



Esquinas redondeadas
Rounded corners
Coins arrondis



Provisto de mezclador antirretorno
Supplied with no-return mixing valve
Munies de valve antiretour mélangeuse

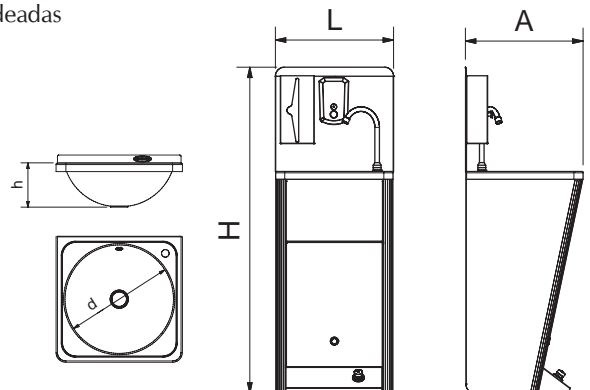

L	A	H	d	h	Kg	Barcode	€
450	450	1.250	390	150	14,20	061414	390,00

Inc Includo / Included / Inclus
Op Opcional / Optional / Optionnel

Lavamanos registrable con pedestal doble pulsador agua fría y caliente

Double push buttons hand wash basin, cold and hot water
Lave-mains avec piédestal, deux poussoirs d'eau froide et chaude

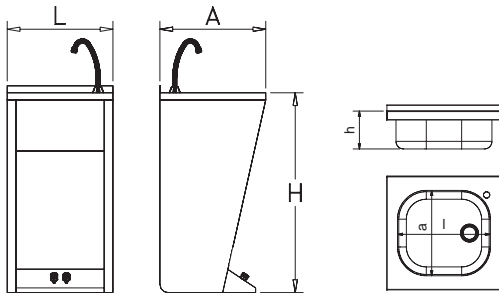

L	A	H	l	a	h	Kg	Barcode	€
450	450	850	370	340	150	12	061014	340,00

Lavamanos registrable de rodilla agua fría y caliente

Knee-operated hot and cold-water hand wash basins
Lave-mains à actionnement par genou eau froide et chaude

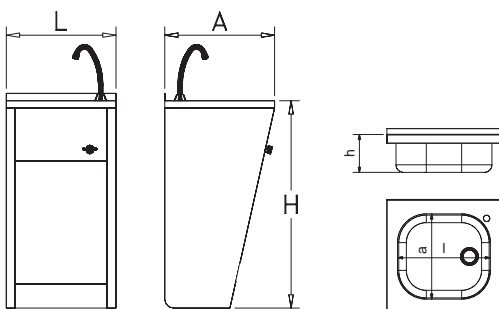

Provisto de mezclador antirretorno
Supplied with no-return mixing valve
Munies de valve antiretour mélangeuse



L	A	H	l	a	h	Kg	Barcode	€
450	450	850	370	340	150	11,96	061002	330,00

Lavamanos registrable con pedal de agua fría y caliente

Pedal-operated hot and cold-water hand wash basins
Lave-mains à actionnement par pédale d'eau froide et chaude



Provisto de mezclador antirretorno
Supplied with no-return mixing valve
Munies de valve antiretour mélangeuse

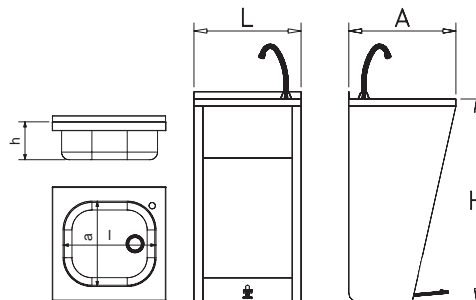

L	A	H	l	a	h	Kg	Barcode	€
450	450	850	370	340	150	11,96	061004	345,00

Lavamanos registrable con doble pedal de agua fría y caliente

Twin pedal-operated hot and cold-water hand wash basins
Lave-mains à actionnement par double pédale d'eau froide et chaude

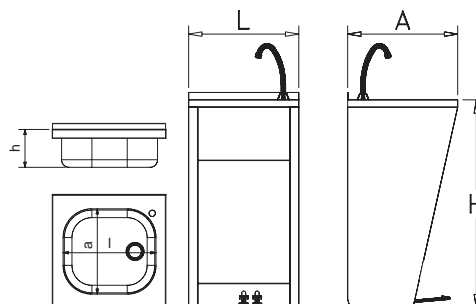

L	A	H	l	a	h	Kg	Barcode	€
450	450	850	370	340	150	12,66	061008	370,00

Lavamanos registrable electrónico de agua fría y caliente

Electronically-operated hot and cold-water hand wash basins
Lave-mains à actionnement électronique à eau froide et chaude



Provisto de mezclador antirretorno
Supplied with no-return mixing valve
Munies de valve antiretour mélangeuse

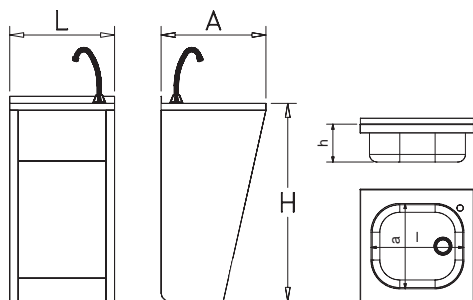

Funcionamiento a pilas
Batteries functioning
Fonctionnement à piles

Máxima fiabilidad:

No necesita instalación eléctrica, pues su funcionamiento es a pilas.
Evita cualquier accidente derivado de las instalaciones eléctricas y el agua.
Duración aproximada de las pilas: 6 meses.

Maximum fiability:

It is not necessary an electrical installation, since its functioning is by batteries.
It avoids any accident derived from electrical installations and water.
Approximate batteries life: 6 months.



L	A	H	l	a	h	Kg	Barcode	€
450	450	850	370	340	150	12,54	061010	475,00

Maximum fiabilité:

Il ne précise pas d'installation électrique puisque son fonctionnement c'est à piles.
Évite quelque accident provoqué par les installations d'électricité et l'eau.
Durée approchée des piles: 6 mois.

Lavamanos integral registrable electrónico

Electronical integral hand wash basin with removable door
Lave-mains intégral électronique avec porte amovible

Dotación de serie:

Lavamanos completo, agua fría y caliente.
Papelerera integrada en el mueble.
Peto trasero.
Dispensador de toallas en acero inoxidable.
Dispensador de jabón en acero inoxidable capacidad 1,2 lt.

Equipment and fittings included:

Fully equipped hand wash basin, hot and cold water.
Wastepaper bin incorporated into the unit.
Backsplash.
Towel dispenser in stainless steel.
Soap dispenser in stainless steel - capacity 1,2 litres.

Équipement et accessoires inclus:

Lave-mains complet, à l'eau froide et chaude.
Corbeille à papier incorporé.
Cuirasse postérieure.
Dispensateur d'essuie-mains en acier inoxydable.
Doseur de savon en acier inoxydable - capacité 1,2 litres.



Funcionamiento a pilas
Batteries functioning
Fonctionnement à piles



Esquinas redondeadas
Rounded corners
Coins arrondis

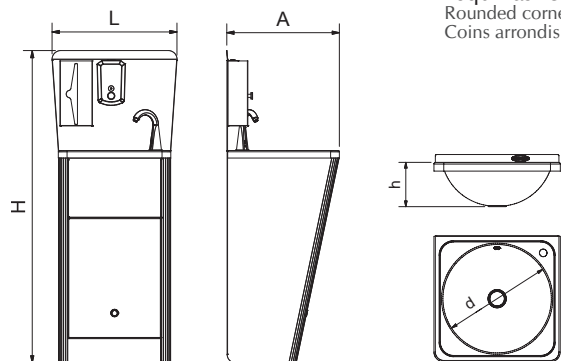

Papelerera integrada
Waste bin integrated
Corbeille à papier intégrée



Provisto de mezclador antirretorno
Supplied with no-return mixing valve
Munies de valve antiretour mélangeuse

L	A	H	d	h	Kg	Barcode	€
450	450	1.250	390	150	15,20	061418	525,00

Lavamanos mural serie XS pulsador rodilla

Hand wash basin wall-mounted XS model knee push button
Lave-main mural modèle XS poussoir genou



La serie de lavamanos XS

Por sus reducidas dimensiones está diseñada para adaptarse a las instalaciones con poco espacio. Su funcionalidad es perfecta, a pesar de su pequeño tamaño, pues incorporamos una nueva cubeta de alto espesor y gran capacidad con reborde antiderrames que asegura su utilidad.

Construidos en acero inoxidable acabado esmerilado Scotch-brite, disponen de una válvula mezcladora antirretorno con la que podrá regular la temperatura de servicio.

The range of hand wash basins XS

It is designed to fit up areas with little room because of its reduced dimensions. Although its small size, it is functionally perfect, since it has a new tank of large capacity, and anti-overflow rim, which ensure its usefulness.

It is made of stainless steel emery polished with scotch-brite finishing. They have a non return mixing valve that will allow you to regulate the temperature.

Les modèles de lave-mains XS

Sont conçus pour s'adapter aux installations où on dispose de peu d'espace. Sa fonctionnalité est parfaite, puisqu'il a un nouveau bac à grande capacité, et rebord pour éviter des trop-pleins.

Construit en acier inoxydable poli à l'émeri avec finition Scotch-brite. Il a une valve mélangeuse anti-retour qui permet régler la température.



460220 38,00 399
Dosificadores de jabón
Soap dispenser
Doseur de savon



060608 26,00 194
Peto postizo para acoplar
Detachable stand to be fitted to hand wash basin
Support amovible pour accopler au lave-mains



080602 58,00 378
Papelera
Wastepaper bin
Corbeille à papier



Provisto de mezclador antirretorno
Supplied with no-return mixing valve
Munies de valve antiretour mélangeuse

Includido / Included / Inclus
 Opcional / Optional / Optionnel

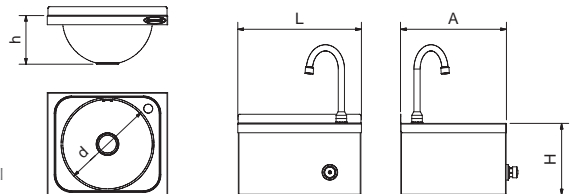

L	A	H	d	h	Kg	Barcode	€
350	300	215	260	115	3,91	061422	190,00

Lavamanos mural de palanca agua fría y caliente

Handle-operated hot and cold water wall-mounted hand wash basin
Lave-mains mural à levier eau foide et chaude



Provisto de mezclador antirretorno
Supplied with no-return mixing valve
Munies de valve antiretour mélangeuse

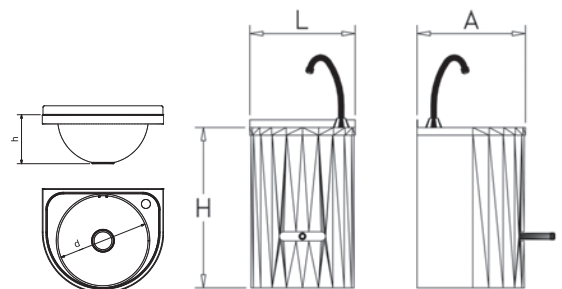

L	A	H	d	h	Kg	Barcode	€
350	300	500	260	115	8	061402	390,00

Lavamanos mural electrónico de agua fría y caliente

Electronically-operated hot and cold-water wall wash basins
Lave-mains mural électronique d'eau à eau froide et chaude

Máxima fiabilidad:

No necesita instalación eléctrica, pues su funcionamiento es a pilas.
Evita cualquier accidente derivado de las instalaciones eléctricas y el agua.
Duración aproximada de las pilas: 6 meses.

Maximum fiability:

It is not necessary an electrical installation, since its functioning is by batteries.
It avoids any accident derived from electrical installations and water.
Approximate batteries life: 6 months.

Maximum fiabilité:

Il ne précise pas d'installation électrique puisque son fonctionnement c'est à piles.
Évite quelque accident provoqué par les installations d'électricité et l'eau.
Durée approchée des piles: 6 mois.

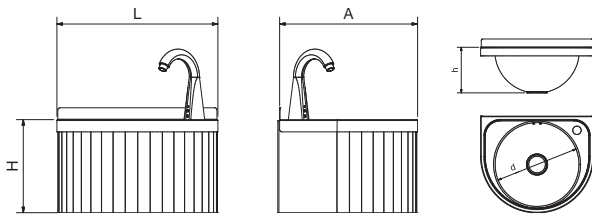

L	A	H	d	h	Kg	Barcode	€
350	300	200	260	115	6	061404	375,00



Provisto de mezclador antirretorno
Supplied with no-return mixing valve
Munies de valve antiretour mélangeuse



Funcionamiento a pilas
Batteries functioning
Fonctionnement a piles

Lavamanos mural electrónico con selector de temperatura

Electronically-operated wall mounted had wash basin with temperature selector
Lave-mains mural électronique avec sélecteur de température

Máxima fiabilidad:

No necesita instalación eléctrica, pues su funcionamiento es a pilas.
Evita cualquier accidente derivado de las instalaciones eléctricas y el agua.
Duración aproximada de las pilas: 6 meses.

Maximum fiability:

It is not necessary an electrical installation, since its functioning is by batteries.
It avoids any accident derived from electrical installations and water.
Approximate batteries life: 6 months.

Maximum fiabilité:

Il ne précise pas d'installation électrique puisque son fonctionnement c'est à piles.
Évite quelque accident provoqué par les installations d'électricité et l'eau.
Durée approchée des piles: 6 mois.

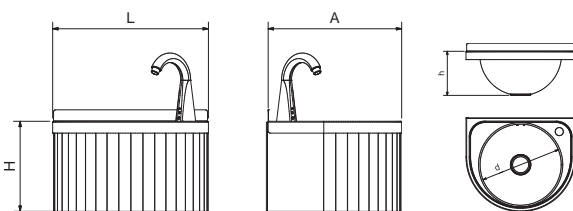

L	A	H	d	h	Kg	Barcode	€
350	300	200	260	115	6	061448	400,00



Funcionamiento a pilas
Batteries functioning
Fonctionnement a piles

Lavamanos mural de esquina serie XS

Wall-mounted corner hand wash basin XS model
Lave-main mural d'angle modèle XS



Provisto de mezclador antirretorno
Supplied with no-return mixing valve
Munie de valve antiretour mélangeuse

Por sus reducidas dimensiones está diseñado para adaptarse a las instalaciones con poco espacio. Su funcionalidad es perfecta, a pesar de su pequeño tamaño, pues incorporamos una nueva cubeta de alto espesor y gran capacidad que asegura su utilidad. Accionamiento de rodilla mediante un pulsador. Totalmente construido en acero inoxidable. Acabado mate satinado. Está provisto de una válvula anti retorno mezcladora que le permite seleccionar el caudal de agua fría y caliente que entran en el circuito. Caño incluido, así como todas las piezas necesarias para su instalación.

It is designed to fit up areas with little room because of its reduced dimensions. Although its small size, it is functionally perfect, since it has a new tank of large capacity, which ensure its usefulness. Knee-operated with push button. Made completely in stainless steel. Satin finish. It is provided with a non-return mixing valve that allows you to select the water temperature. The swan neck tap and all the accessories needed for the assembly are included.



061424

Ejemplo de lavamanos de esquina con peto postizo opcional 060612
Example of corner hand-washbasin with optional backsplash code 060612
Exemple de lave-main d'angle avec dosseret optionnel code 060612



061424 + 060612

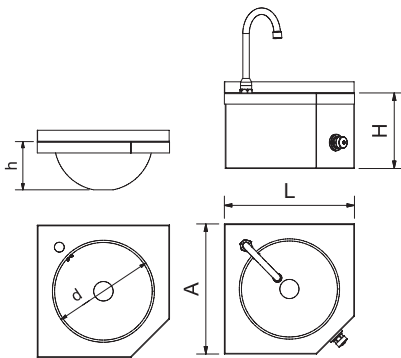

Spécial pour des établissements où il n'y a pas beaucoup de place. Malgré sa petite taille, sa fonctionnalité est parfaite : il a un bac de grand épaisseur et haute capacité. Commande fémorale avec bouton poussoir. Totalement construit en acier inoxydable. Finition brossé mat. Il est pourvu d'une valve anti-retour mélangeuse, qui sert à sélectionner la quantité d'eau froide et chaude qui rentre dans le circuit. Le col de cygne est inclus, ainsi que toutes les pièces nécessaires pour l'installation.

L	A	H	d	h	Kg	Barcode	€
350	350	205	260	115	3	061424	307,00

Lavamanos mural serie XS dos aguas

Double tap hand wash basin XS model
Lave-main à deux eaux modèle XS



Por sus reducidas dimensiones está diseñado para adaptarse a las instalaciones con poco espacio. Su funcionalidad es perfecta, a pesar de su pequeño tamaño, pues incorporamos una nueva cubeta de alto espesor y gran capacidad con reborde antiderrames que asegura su utilidad. Construido en acero inoxidable. Se suministra con grifería, válvula de desagüe y rebosadero.



It is designed to fit up areas with little room because of its reduced dimensions. Although its small size, it is functionally perfect, since it has a new tank of large capacity, and anti-overflow rim, which ensure its usefulness. Fully made of stainless steel. Supplied with taps, waste and overflow.

Sont conçus pour s'adapter aux installations où on dispose de peu d'espace. Sa fonctionnalité c'est parfaite, puisqu'il a un nouveau bac à grande capacité, et rebord pour éviter des trop-pleins. Fabriqué en acier inoxydable. Fourni avec robinets et valvule d'écoulement avec déversoir.

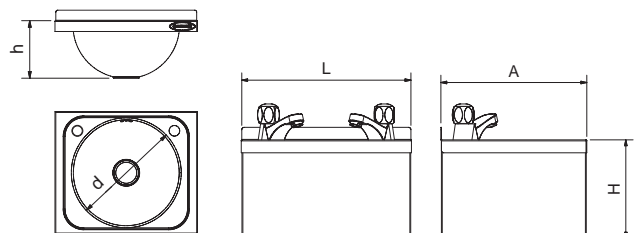

L	A	H	d	h	Kg	Barcode	€
350	300	200	260	115	2,32	061432	189,00

Lavamanos mural de rodilla agua fría y caliente

Knee-operated hot and cold-water wall-mounted hand wash basins
Lave-mains mural à actionnement par genou eau froide et chaude



Provisto de mezclador antirretorno
Supplied with no-return mixing valve
Munies de valve antiretour mélangeuse

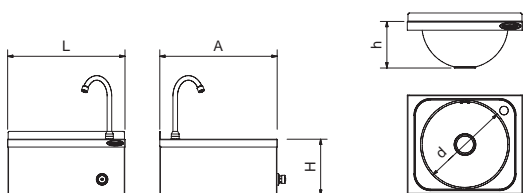

L	A	H	d	h	Kg	Barcode	€
450	450	215	390	150	5,59	061202	215,00

Lavamanos mural de rodilla modelo RC de agua fría y caliente

Knee-operated hot and cold-water wall mounted hand wash basin RC model
Lave-mains mural à actionnement par genou eau froide et chaude modèle RC



Esquinas redondeadas
Rounded corners
Coins arrondis



Provisto de mezclador antirretorno
Supplied with no-return mixing valve
Munies de valve antiretour mélangeuse

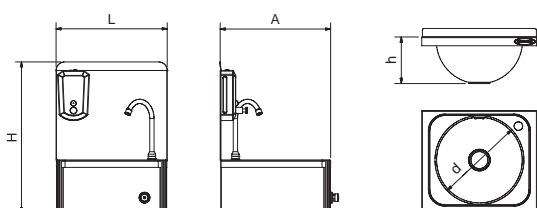

L	A	H	d	h	Kg	Barcode	€
453	450	615	390	150	7	061212	360,00



Lavamanos integral mural pulsador rodilla

Wall-mounted integral hand wash basin knee push button
Lave-mains mural intégral poussoir genou



Dotación de serie:

Lavamanos completo, agua fría y caliente.
Papelera ergonómica.
Peto trasero.
Dispensador de toallas en acero inoxidable.
Dispensador de jabón en acero inoxidable capacidad 1,2 lt.

Equipment and fittings included:
Full hand wash basin, hot and cold water.
Designer wastepaper bin.
Backsplash.
Towel dispenser in stainless steel.
Soap dispenser in stainless steel capacity 1,2 litres.

Équipement et accessoires inclus:
Lave-mains complet, à l'eau froide et chaude.
Corbeille à papier ergonomique.
Cuirasse postérieure.
Dispensateur d'essuie-mains en acier inoxydable.
Doseur de savon en acier inoxydable capacité 1,2 litres.



Esquinas redondeadas
Rounded corners
Coins arrondis



Provisto de mezclador antirretorno
Supplied with no-return mixing valve
Munie de valve antiretour mélangeuse

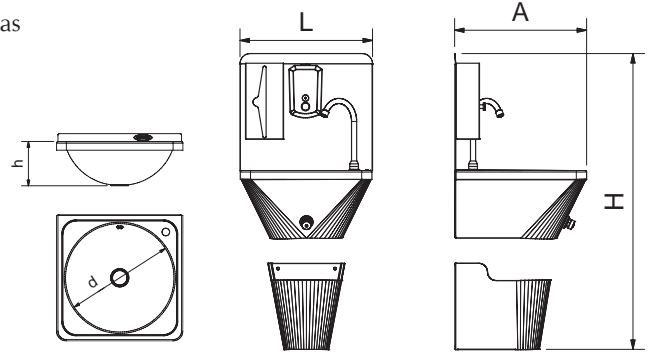

L	A	H	d	h	Kg	Barcode	€
450	450	1.050	390	150	10,49	061406	385,00

Lavamanos mural con pedal de agua fría y caliente

Pedal-operated hot and cold-water wall-mounted hand wash basins
Lave-mains mural avec pédale d'eau froide et chaude



Provisto de mezclador antirretorno
Supplied with no-return mixing valve
Munie de valve antiretour mélangeuse

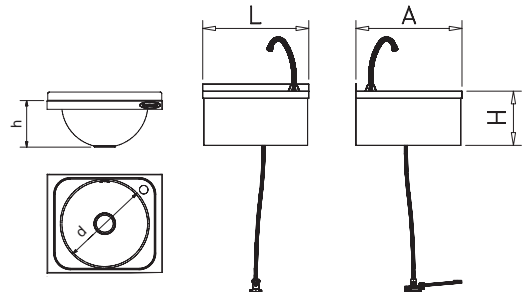

L	A	H	d	h	Kg	Barcode	€
450	450	215	390	150	5,46	061204	244,00

Lavamanos mural con doble pedal de agua fría y caliente

Twin pedal-operated hot and cold-water wall-mounted hand wash basins
Lave-mains mural avec double pédale à eau froide et chaude

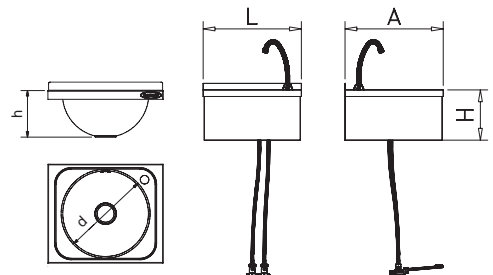

L	A	H	d	h	Kg	Barcode	€
450	450	215	390	150	6,60	061208	288,00

Lavamanos mural electrónico de agua fría y caliente

Electronically-operated hot and cold-water wall-mounted hand wash basins
Lave-mains mural électronique d'eau à eau froide et chaude

Máxima fiabilidad:

No necesita instalación eléctrica, pues su funcionamiento es a pilas.
Evita cualquier accidente derivado de las instalaciones eléctricas y el agua.
Duración aproximada de las pilas: 6 meses.

Maximum fiability:

It is not necessary an electrical installation, since its functioning is by batteries.
It avoids any accident derived from electrical installations and water.
Approximate batteries life: 6 months.

Maximum fiabilité:

Il ne précise pas d'installation électrique puisque son fonctionnement c'est à piles.
Évite quelque accident provoqué par les installations d'électricité et l'eau.
Durée approchée des piles: 6 mois.



Funcionamiento a pilas

Batteries functioning
Fonctionnement à piles



Provisto de mezclador antirretorno
Supplied with no-return mixing valve
Munies de valve antiretour mélangeuse

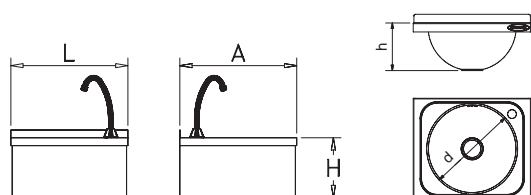

L	A	H	l	h	Kg	Barcode	€
450	450	215	390	150	6,14	061210	360,00

Lavamanos integral mural electrónico

Electronical wall-mounted integral hand wash basin
Lave-mains électronique mural intégral

Dotación de serie:

Lavamanos completo, agua fría y caliente.
Papelera ergonómica.
Peto trasero.
Dispensador de toallas en acero inoxidable.
Dispensador de jabón en acero inoxidable capacidad 1,2 lt.

Equipment and fittings included:

Full hand wash basin, hot and cold water.
Designer wastepaper bin.
Backsplash.
Towel dispenser in stainless steel.
Soap dispenser in stainless steel - capacity 1,2 litres.

Équipement et accessoires inclus:

Lave-mains complet, à l'eau froide et chaude.
Corbeille à papier ergonomique.
Cuirasse postérieure.
Dispensateur d'essuie-mains en acier inoxydable.
Doseur de savon en acier inoxydable - capacité 1,2 litres.



Funcionamiento a pilas

Batteries functioning
Fonctionnement à piles



Esquinas redondeadas
Rounded corners
Coins arrondis



Provisto de mezclador antirretorno
Supplied with no-return mixing valve
Munies de valve antiretour mélangeuse

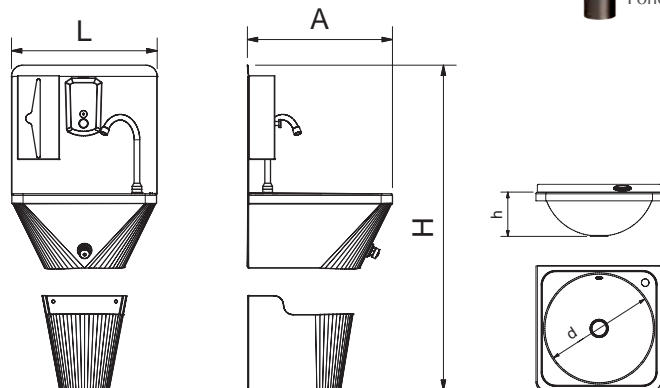

L	A	H	d	h	Kg	Barcode	€
450	450	1.050	390	150	12,66	061410	495,00

Conjunto lavamanos y fregadero mural

Double bowl wall-mounted hand wash basin-sink
Évier lave-mains suspendu à deux bacs



Provisto de mezclador antirretorno
Supplied with no-return mixing valve
Munies de valve antiretour mélangeuse

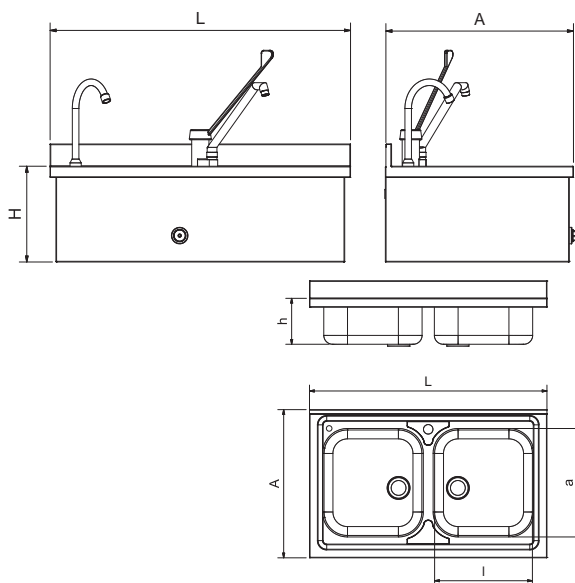

L	A	H	I	a	h	Kg	Barcode	€
800	500	255	330	360	160	12	054202	520,00

Conjunto lavamanos y fregadero mural XS

Double tank wall-mounted hand wash basin-sink XS model
Évier lave-mains suspendu à deux bacs XS



Provisto de mezclador antirretorno
Supplied with no-return mixing valve
Munies de valve antiretour mélangeuse

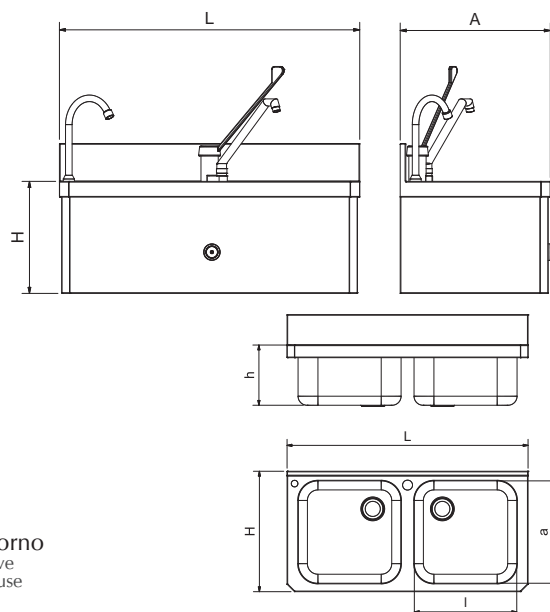

L	A	H	I	a	h	Kg	Barcode	€
800	400	300	340	340	200	15,5	054204	705,00

Lavamanos mural colectivo de rodilla agua fría y caliente

Knee-operated hot and cold water wall-mounted collective washbasin
Lave-main mural collectif à actionnement par genou eau froide et chaude



460252



132,00



396

Espejo Inox
Stainless steel mirror
Miroir inox



065004



575,00



392

Urinario inox
Inox urinal
Urinoir inox



Provisto de mezclador antirretorno
Supplied with no-return mixing valve
Munies de valve antiretour mélangeuse

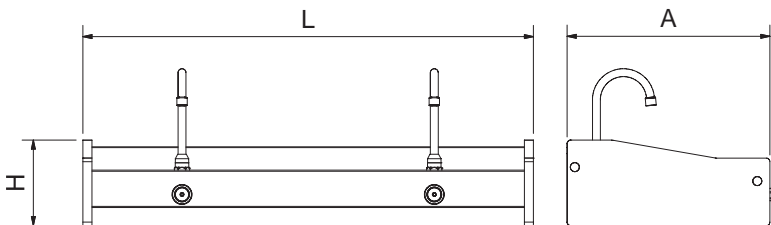

L	A	H	🔩	Kg	📊	€
1.000	450	190	2	12	061436	500,00
1.500	450	190	3	17	061438	670,00
2.000	450	190	4	22	061440	795,00

Lavamanos mural colectivo

Wall-mounted collective washbasin
Lave-main mural collectif

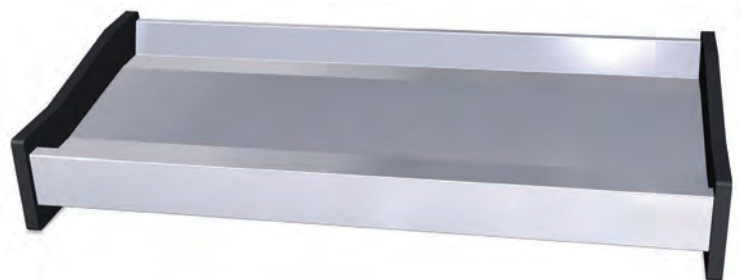

Sin accesorios ni taladros.
Without accessories or drills
Sans accessoires ni poinçonnages

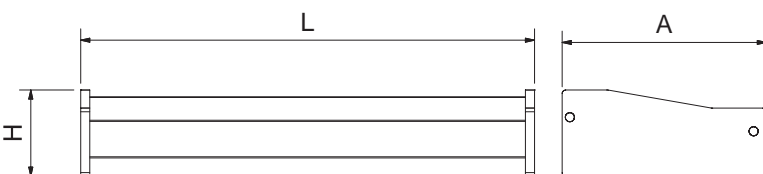

L	A	H	Kg	📊	€
1.000	450	190	10	061442	420,00
1.500	450	190	14	061444	498,00
2.000	450	190	18	061446	577,00



231

Configure este lavamanos incorporando la grifería que mas se ajuste a sus necesidades.
You can form this washbasin by incorporating the taps that best suit your needs.
Vous pouvez former ce lave-mains en intégrant les robinets qui conviennent le mieux à vos besoins.

Pie inox para lavamanos mural colectivo

Stainless steel foot for collective hand washbasin
Pied inox pour lave-mains collectif



Características principales:

Este producto convierte un lavamanos mural colectivo en un lavamanos con pie.
Mejora el aspecto al esconder todas las conexiones detrás de los pies.
Aumenta la estabilidad.
Fabricado enteramente en acero inoxidable.

Main characteristics:

This accessory converts our wall-mounted collective washbasins in standing models.
It hides all the connections behind the supports, for a better looking.
It increases the stability.
Made entirely of stainless steel.

Caractéristiques principales:

Ce produit transforme nos lave-main mural collectif dans modèles sur pieds.
Il cache toutes les connexions derrière les pieds, pour une plus belle apparence.
Il augmente la stabilité.
Fabriqué entièrement en acier inoxydable.

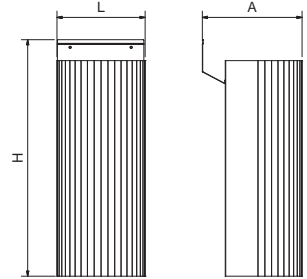

L	A	H	Kg	Barcode	€
317	392	930	5,50	061434	145,00

Lavamanos registrable portátil autónomo grandes eventos

Mobile hand washbasin with self-contained free standing system for large events
Lave-mains autonome registrable portable grands événements



Características principales:

Con dos caños.
Doble pulsador hidráulico de gran caudal.
Cuatro bidones de 20 lts.

Main characteristics:

Double spout.
Double high flow hydraulic push button.
Four 20 lts. tanks.

Caractéristiques principales:

Avec deux becs
Double bouton-poussoir hydraulique à grand débit
Quatre bidons de 20 lts.

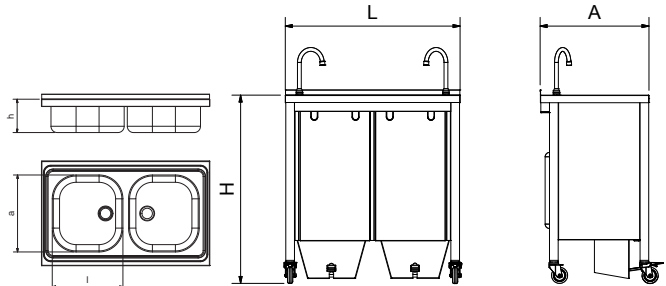

L	A	H	l	a	h	Kg	Barcode	€
800	500	850	340	370	150	24	061474	1.430,00

Calentador de agua instantáneo

Instant water heater
Chauffe-eau instantané



Características principales:

Diseñado para proporcionar agua caliente a un solo lavamanos. Calienta el agua mediante su paso por un serpentín eléctrico.

Main characteristics:

It is designed to provide instantaneous hot water to one hand washbasin, by means of an electric coil.

Caractéristiques principales:

Il est conçu pour fournir de l'eau chaude instantanée au lave-main, au moyen d'une bobine électrique.

Temperatura de salida del agua de 35° a 50°

Leaving water temperature 35° - 50°
Température de sortie d'eau 35° - 50°

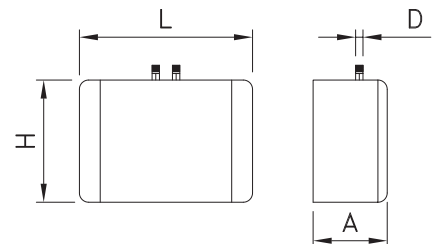

L	A	H	D	°C	l/min	Potencia Power Puissance	Tensión Voltage Tension	Frecuencia Frequency Fréquence	Kg	Barcode	€
187	80	132	3/8"	50°C	2,0	4.400 W	230 V	50 Hz.	1,10	461456	251,00

Repuestos y accesorios para lavamanos









Spare parts for hand wash basins
Pièces de rechange pour lave-mains



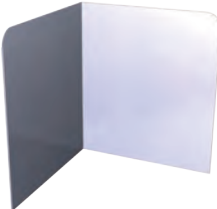









	Descripción Description Description	Modelo Model Model			
	Pedal de un agua M-M de 1/2" M-M 1/2" single inlet water pedal Pédale à une eau M-M d'1/2"		425	460602	55,00
	Pedal mezclador de agua fría y caliente M-M-M de 1/2" M-M-M 1/2" hot and cold-water mixer pedal Pédale mélangeuse eau froide et eau chaude M-M-M d'1/2"		770	460604	98,00
	Pulsador no temporizado M-M de 1/2" Push-button M-M 1/2" not timer Bouton-poussoir non temporisé M-M d'1/2"		390	460404	40,00
	Pulsador temporizado M-M de 1/2" Push-button M-M 1/2" timer Bouton-poussoir temporisé M-M d'1/2"		390	460410	40,00
	Kit de juntas para pulsador temporizado Gasket kit for push button timer Kit de joints pour bouton-poussoir temporisé		5	460450	4,00
	Grifo de palanca un agua M-M de 1/2" Twist waste handle tap M-M 1/2" Robinet à levier M-M d'1/2"		1.350	463802	107,00
	Caño fijo 1/2" Fixed spout 1/2" Jet fixe 1/2"	Fijo Fixed Fix	420	461002	40,00
	Caño giratorio 1/2" Rotating spout 1/2" Jet giratoire 1/2"	Giratorio Rotating Giratoire	250	461008	35,00
	Caño giratorio extra bajo 1/2" Extra low rotating spout 1/2" Jet giratoire extra bas 1/2"	Giratorio Rotating Giratoire	280	461010	40,00

Repuestos y accesorios para lavamanos

Spare parts for hand wash basins









Pièces de rechange pour lave-mains

	Descripción Description Description	Modelo Model Model				
					Gr	€
	Peto postizo para acoplar Detachable backsplash to be fitted to hand wash basin Dossieret amovible pour accoupler au lave-mains	350x400 mm	1.120	060608		26,00
	Peto lavamanos integral Backsplash for integral hand wash basins Dossieret lavemains intégral	450x400 mm	1.450	060602		26,00
	Peto postizo de esquina Corner backsplash Dossieret d'angle	350 + 350x400 mm	2.300	060612		53,00
	Papelera modelo Design (lavamanos integral mural) Design model wastepaper bin (wall mounted integral hand wash basins) Corbeille à papier modèle Design (lavemains intégral mural)		2.300	080608		72,00
	Papelera-dispensador de papel Paper bags dispenser Distributeur de sacs en papier		2.000	080424		65,00
	Válvula con rebosadero para lavamanos de 450x450 mm Drain valve with overflow for 450x450 mm hand wash basins. Valvule de drainage avec déversoir pour lave-mains de 450x450 mm		145	454202		9,00
	Válvula de PVC con rebosadero, acabado cromado 1 1/2" Drain valve in PVC with overflow, chrome finished 1 1/2" Valvule de drainage avec déversoir en PVC, finition chromé 1 1/2"		150	454205		30,00
	Rebosadero para lavamanos 061402, 061404 y 061448 Overflow for 061402, 061404 and 061448 hand wash basins Déversoir pour lave-mains 061402, 061404 et 061448		2	454206		4,50
	Latiguillos flexibles en malla de acero inoxidable H-H de 1/2" H-H 1/2" stainless-steel flexible hoses Flexibles en maille d'acier inoxydable H-H d'1/2"	400 mm	100	461202		5,00
		600 mm	120	461206		6,00
		700 mm	140	461208		6,00
		800 mm	180	461210		7,00
		900 mm	200	461212		8,00
		1.200 mm	240	461214		7,50
		1.500 mm	345	461216		9,00

		Descripción Description Description		Gr	Barcode	€
		Desagüe flexible para lavamanos autónomo 1 1/2" Flexible drain hose for autonomous wash basin 1 1/2" Tuyau de drainage flexible pour lave main autonome 1 1/2"	125	454260	13,00	
		Sifón de desagüe para lavamanos 1 1/2" U-bended drainpipe for hand wash basins 1 1/2" Siphon de drainage pour lave-mains 1 1/2"	169	454402	8,00	
		Sifón de PVC acabado cromado 1 1/2" U-bended drainpipe in PVC, chrome finished 1 1/2" Siphon en PVC, finition chromé 1 1/2"	170	454408	32,00	
		Sifón de latón cromado 1 1/2" U-bended drainpipe in chrome brass 1 1/2" Siphon en laiton chromé 1 1/2"	1.400	454404	86,00	
		Bidón apilable translúcido 20 lts para fregadero autónomo Container for Portable Stainless steel sinks (20 Litre) Bidon d'eau de 20 litres pour Plonge inox autonome	360	461426	38,00	
		Bidón de 10 lts para lavamanos autónomo 10 litres water drum for autonomous wash basin Bidon d'eau de 10 litres pour lave main autonome	360	461428		19,00
					14,00	
		Goma elástica para la sujeción de bolsas de basura en lavamanos Elastic strap for hand wash basins Tendeurs élastiques pour lave-mains	125	464406	3,00	
		Rueda de plástico ø50x18 mm. para lavamanos autónomo Plastic wheel ø50x18 mm. for autonomous wash basin Roulette en plastic ø50x18 mm. pour lave main autonome	25	485020	4,00	
		Tapón inox cubre-agujeros (diámetro 42 mm) Hole-cover plug in stainless steel (diameter 42 mm) Bonde couvre-trou en acier inox (diamètre 42 mm)	16	454602	6,00	

Repuestos y accesorios para lavamanos

Spare parts for hand wash basins
Pièces de rechange pour lave-mains

	Descripción Description Description			
	Hacer agujero en fregadero o lavamanos Drill hole to sink Faire trou à plonge		056802	29,00
	Válvula mezcladora termostática H-H-H de 1/2" H-H-H 1/2" thermostatic mixing valve Valve mélangeuse thermostatique H-H-H d'1/2"	620	461402	87,00
	Mezclador antiretorno M-H-M 1/2" M-F-M 1/2" no-return mixing valve Valve antiretour mélangeuse M-H-M d'1/2"	150	461604	25,00
	Válvula de esfera H-H de 1/2" F-F 1/2" valve Valve H-H d'1/2"	140	461404	9,00
	Válvula antiretorno H-H de 1/2" F-F 1/2" non-return valve Valve antiretour H-H d'1/2"	140	462202	8,00
	"T" mezcladora M-H-M de 1/2" M-F-M 1/2" "T" mixer "T" mélangeur M-H-M d'1/2"	80	461602	5,00
	Codo a 90° M-H de 1/2" M-F 1/2" 90° angle Coude à 90° M-H d'1/2"	80	461802	3,00
	Unión M-M de 1/2" M-M 1/2" union Jonction M-M d'1/2"	20	462002	2,00
	Dosificador de jabón encastrable 600 ml. Stainless steel soap dispenser to be embedded 600 ml. Doseur de savon en acier inoxydable pour adosser 600 ml.	580	460218	70,00

FUENTES DE AGUA

Drinking fountains
Fontaine d'eau

Fuentes de agua

La combinación de un cuidado diseño y una gran calidad en los materiales empleados, dan como resultado una gama de fuentes que se adaptan a las exigencias actuales cumpliendo con todas las normativas vigentes.

Su construcción en acero inoxidable permite su utilización en interiores o exteriores.

Los modelos murales se pueden instalar a una altura más baja, para niños o personas discapacitadas.

Ideal en oficinas, vestuarios, instalaciones deportivas, colegios, centros comerciales, etc.

Drinking fountains

The combination of careful design and high quality materials used, resulting in a range of sources to suit the current requirements in compliance with all regulations.

Made in stainless steel. They can be placed indoors or outdoors. The wall models can be installed at a lower height for children or people who need it.

Recommended for offices, locker rooms, sports facilities, schools, shopping centers, etc.

Les sources d'eau

La combinaison d'une conception attentive et matériaux de haute qualité utilisé, résultant dans une variété de sources pour répondre aux exigences actuelles de conformité avec tous les règlements.

Sa construction en acier inoxydable permet une utilisation à l'intérieur ou à l'extérieur.

Les modèles muraux peuvent être installés à une hauteur inférieure pour les enfants ou les personnes qui en ont besoin. Idéal pour les bureaux, les vestiaires, des installations sportives, écoles, centres commerciaux, etc.



Fuentes de agua fría, caliente y del tiempo Futura

Drinking fountains Futura, for cold, hot and room temperature water
Fontaines d'eau froide, chaude et à température ambiante Futura

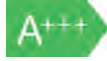

Características principales:

La fuente de agua fría más compacta del mercado. Especial para espacios reducidos. Máxima ergonomía.
Dispensador de vasos. Va dotada con 100 vasos de serie.
Dispensador para llenar botellas y recipientes de grandes dimensiones.
Dotada de filtro de agua de carbón activado 3M de 0,5 micras de serie. Certificado NSF y EN 1935/2004. Duración 4.000 litros aproximadamente.
Depósito de acero inoxidable de 2 lt de capacidad con certificación NSF.
No lleva válvula de flotador para mayor higiene.
Tecnología Silver para maximizar la higiene.
Control del nivel de frío. Termostato interno.
Funcionamiento súper silencioso
Compresor de 1/15 HP modo ahorro de energía. Soporta temperaturas ambiente de hasta 43°.
Entrada con conexión rápida de agua de 1/4".
Panel de acero inoxidable fácilmente desmontable para facilitar el mantenimiento.
Calentador de agua de 2.000 W.
Tanque suplementario de agua caliente de 0,8 litros y 45 tazas/hora de capacidad y fabricado en acero inoxidable.
Temperatura controlada mediante microprocesador para priorizar el ahorro de energía. Máxima temperatura 97°.
Fabricada en la Unión Europea.
Los filtros se deberán cambiar cada 4.000 lts. o 6 meses. Lo que antes se dé.

*Nota: La alimentación de agua de la fuente debe ser agua apta para el consumo humano (agua potable). En ningún caso el equipo adaptará o convertirá agua al consumo humano que no lo sea, ni antes ni después de pasar por el equipo.

Main characteristics:

The smallest cold water drinking fountain, specially for reduced spaces. Superior ergonomics.
Cup dispenser. Provided with 100 cups.
Dispenser for filling bottles and large containers
Provided with 0.5 microns activated carbon water filter 3M for 4.000 liters aprox. NSF and EN 1935/2004 certified
Two liters capacity stainless steel container with NSF certification.
Without float valve for a maximum hygiene.
Silver technology to maximize the hygiene.
Cooling controlled. Internal thermostat.
Smooth silent running.
Energy saving compressor 1/15 HP. Resistant to environmental temperatures up to 43°C.
Quick connector 1/4" for water inlet.
Stainless steel panel easy to remove to facilitate the maintenance.
Water heater 2.000 W.
Additional container of 0,8 liters for hot water with capacity for 45 cups per hour. Made of stainless steel.
Temperature controlled by microprocessor to prioritize the energy saving. Maximum temperature 97°C.
Made in the European Union
The filters must be changed every 4.000 liters or 6 months. Whatever earlier comes.

*Comments: the water supply must be suitable for human consumption (drinking water). Under no circumstance this device will convert or adapt non drinking water to suitable for human consumption, before or after bypassing through the device.





Caractéristiques principales:

La fontaine d'eau froide de taille la plus réduite du marché. Spécialement conçu pour les espaces réduits. Ergonomie maximum.
Distributeur de verres. Possède 100 verres de série.
Distributeur pour remplir bouteilles et récipients de grandes dimensions.
Possède un filtre à charbon actif 3M de 0,5 microns de série. Certificat NSF et EN 1935/2004. Durée 4.000 litres environ.
Réservoir d'acier inoxydable avec deux litres de capacité avec certificat NSF.
Ne contient pas de valve de flotteur pour une meilleure hygiène.
Technologie Silver pour un maximum d'hygiène.
Control du niveau du froid. Thermostat interne.
Fonctionnement super silencieux.
Compresseur de 1/15 HP en mode économie d'énergie. Supporte des températures ambiantes jusqu'à 43°.
Entrée avec connection rapide d'eau de 1/4"
Panneau en acier inoxydable facilement démontable pour faciliter la maintenance.
Chauffe eau de 2.000 W.
Réservoir supplémentaire d'eau chaude de 0,8 litres et 45 tasses par heures de capacité. Fabriqué en acier inoxydable.
Température contrôlée à travers un microprocesseur pour privilégier l'économie d'énergie. Température maximum 97°
Fabriquées dans l'Union Européenne
Les filtres doivent se changer chaque 4.000 lts ou tous les 6 mois. Des deux, la première situation qui se produise.

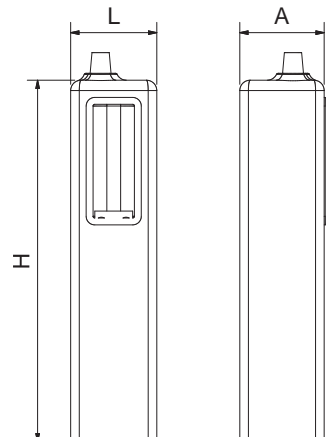
* Note : l'alimentation d'eau de la fontaine doit être de l'eau appropriée à la consommation humaine (eau potable). En aucun cas le matériel s'adaptera ou convertira en eaux pour la consommation humaine, des eaux qui ne le sont pas, ni avant, ni après leur passage par le matériel.

°C de entrada de agua °C inlet water °C eau d'entrée	Refrigeración Refrigeration Réfrigération	°C Salida de agua °C Output Water °C Eau de sortie	
25 °C	-4 °C	21 °C	33
25 °C	-14 °C	11 °C	9



L	A	H	Potencia Power Puissance	Tensión Voltage Tension	Frecuencia Frequency Fréquence			€
			2.000 W			20	464202	1.015,00
	250	175	50 W	220 V	50 Hz.	18	464204	897,00
								

Características principales:

La fuente de agua fría más veloz del mercado. Capaz de enfriar el agua en menos de tres minutos el modelo de suelo.
Potencia de refrigeración única de 450 Kcak/h (el modelo de suelo).
Dotada de grifo llena-jarras.
Control del nivel de frío. Termostato interno.
Funcionamiento súper silencioso.
Compresor de 1/6 HP modo ahorro de energía. Soporta temperaturas ambiente de hasta 43°C.
Entrada de agua de 1/4".
Panel de acero inoxidable fácilmente desmontable para el mantenimiento. Máxima robustez.
Máxima ergonomía.
Fabricada en la Unión Europea.

*Nota: La alimentación de agua de la fuente debe ser agua apta para el consumo humano (agua potable). En ningún caso el equipo adaptará o convertirá agua al consumo humano que no lo sea, ni antes ni después de pasar por el equipo.

Main characteristics:

The drinking fountain with the most rapid cooling in the market. It is capable of cooling the water in less than three minutes (floor).
Single cooling power 450 Kcal/h (floor).
Provided of swan neck tap.
Temperature level controlled by internal thermostat.
Silent functioning.
Compressor of 1/6 HP with energy saving mode. It withstands ambient temperatures up to 43°C
Water inlet 1/4".
Stainless steel front panel, easily detachable to facilitate the maintenance. Maximum ergonomics and solidity.
Made in EU.

Note: the water feed must be fit for human consumption (drinking water). Under no circumstance this device will convert non-drinking water into drinking water.

Caractéristiques principales:

La fontaine d'eau fraîche la plus rapide du marché. Capable de refroidir l'eau en moins de trois minutes(sol).
Puissance de réfrigération unique de 450 Kcak/h(sol).
Avec robinet pour remplir les pichets.
Control du niveau du froid. Thermostat interne.
Fonctionnement super silencieux.
Compresseur de 1/6 HP mode économie d'énergie. Supporte températures ambiantes jusqu'à 43°C.
Entrée d'eau 1/4".
Panneau en acier inox facilement démontable pour faciliter la maintenance. Un maximum de robustesse.
Un maximum d'ergonomie.
Fabriquée en U.E.

* Note : l'alimentation d'eau de la fontaine doit être de l'eau appropriée à la consommation humaine (eau potable). En aucun cas le matériel s'adaptera ou convertira en eaux pour la consommation humaine, des eaux qui ne le sont pas, ni avant, ni après leur passage par le matériel.

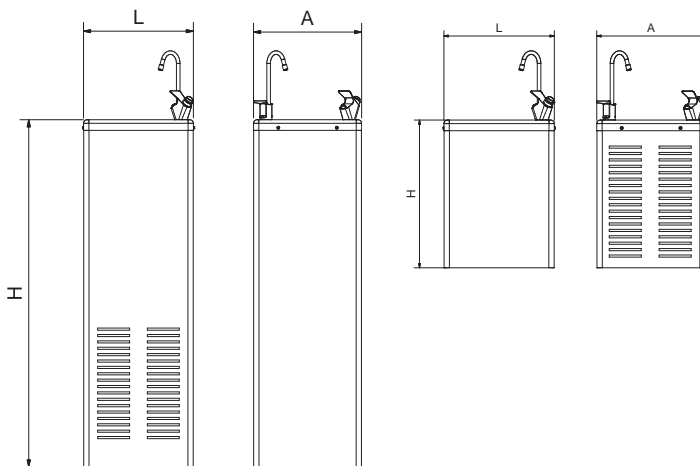
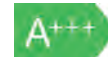
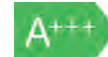

L	A	H	Potencia Power Puissance	Tensión Voltage Tension	Frecuencia Frequency Fréquence	Kg	Barcode	€
310	305	980	125 W	220 V	50 Hz.	26,0	464206	977,00
		415				17,0	464208	878,00

°C de entrada de agua °C inlet water °C eau d'entrée	Refrigeración Refrigeration Réfrigération	°C Salida de agua °C Output Water °C Eau de sortie	Icon
25 °C	-4 °C	21 °C	107
25 °C	-14 °C	11 °C	31

Fuente de columna sin refrigeración

Column fountain - Unrefrigerated
Fontaine colonne - Sans réfrigération

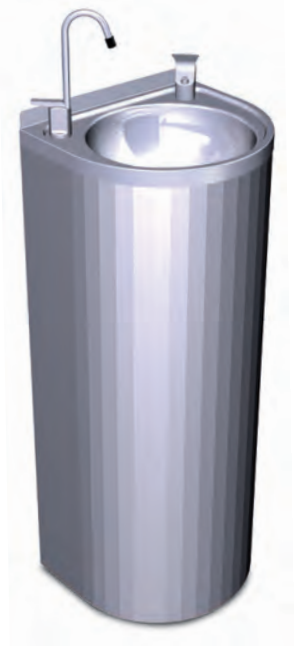

Características principales:

Su construcción en acero inoxidable permite su utilización en interiores o exteriores. Ideal en oficinas, vestuarios, instalaciones deportivas, colegios, centros comerciales, etc.

Main characteristics:

Made in stainless steel. They can be placed indoors or outdoors. Recommended for offices, locker rooms, sports facilities, schools, shopping centers, etc.

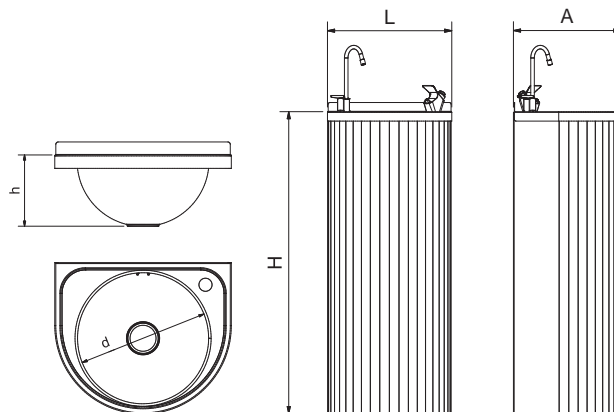

Caractéristiques principales:

Sa construction en acier inoxydable permet une utilisation à l'intérieur ou à l'extérieur.

Idéal pour les bureaux, les vestiaires, des installations sportives, écoles, centres commerciaux, etc.

L	A	H	d	h	Kg	Barcode	€
350	300	850	260	115	7	064206	290,00

Fuente de columna de pedal sin refrigeración

Pedal-operated column fountain - Unrefrigerated
Fontaine colonne avec pédale - Sans réfrigération

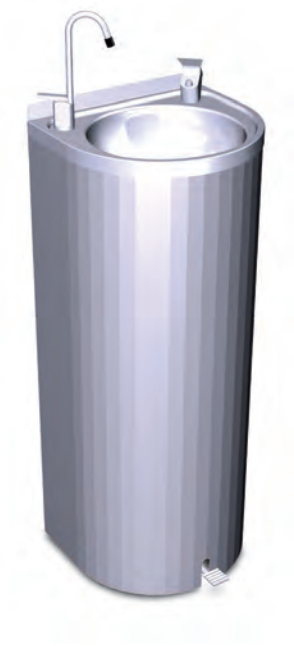

Características principales:

Su construcción en acero inoxidable permite su utilización en interiores o exteriores. Ideal en oficinas, vestuarios, instalaciones deportivas, colegios, centros comerciales, etc.

Main characteristics:

Made in stainless steel. They can be placed indoors or outdoors. Recommended for offices, locker rooms, sports facilities, schools, shopping centers, etc.

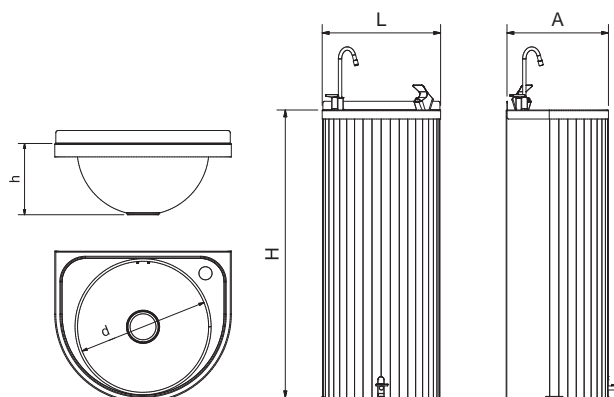

Caractéristiques principales:

Sa construction en acier inoxydable permet une utilisation à l'intérieur ou à l'extérieur.

Idéal pour les bureaux, les vestiaires, des installations sportives, écoles, centres commerciaux, etc.

L	A	H	d	h	Kg	Barcode	€
350	300	850	260	115	7	064212	385,00

Fuente mural redonda sin refrigeración
 Wall-mounted round fountain - Unrefrigerated
 Fontaine mural ronde - Sans réfrigération

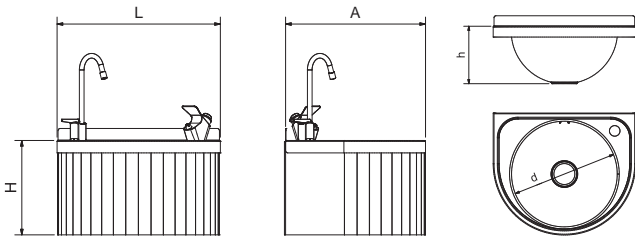

L	A	H	d	h	Kg	Barcode	€
350	300	200	260	115	6	064208	205,00

Fuente mural de esquina sin refrigeración
 Wall-mounted corner fountain - Unrefrigerated
 Fontaine mural d'angle - Sans réfrigération

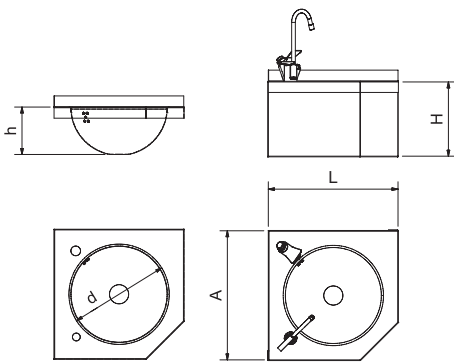

L	A	H	d	h	Kg	Barcode	€
350	350	205	260	115	3	064210	350,00

Fuente de fijación mural sin refrigeración
 Wall-mounted fountain - Unrefrigerated
 Fontaine fixation murale - Sans réfrigération

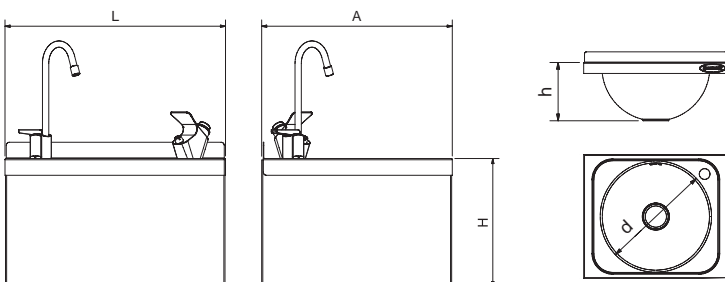

L	A	H	d	h	Kg	Barcode	€
350	300	200	260	115	2,08	064204	185,00

Enfriador de agua

Water cooler
Refroidisseur d'eau



Caractéristiques:

Ideal pour installer de l'eau froide sur des éviers, lavemains, fontaines, etc.

Technologie pour améliorer l'hygiène.

Thermostat pour régler la température de l'eau.

Économie d'énergie grâce à son compresseur de 1/6 Hp.

CE

Fabriquée en Union Européenne

Entrée et sortie d'eau grâce à une connexion rapide 8mm

Schuko plug.

Capable de refroidir l'eau en seulement trois minutes

Acier inox

Entrée et sortie d'eau Shouko de 1/4"

Características:

Ideal para instalar agua fría en fregaderos, lavamanos, fuentes, etc. Tecnología para mejorar la higiene.

Termostato para regular la temperatura del agua.

Ahorro de energía gracias a su compresor de 1/6 Hp.

CE

Fabricado en la unión Europea.

Entrada y salida de agua mediante conexión rápida 8 mm.

Schuko plug.

Capaz de enfriar el agua en solo tres minutos.

Envolverte de acero inoxidable

Entrada y salida de agua Shouko de 1/4"

Characteristics:

Ideal for incorporating cool water in sink units, hand washbasins, drinking fountains, etc.

Technology for a better hygiene

Temperature adjustment by thermostat

Energy saving through compressor - 1/6 Hp

CE

Made in UE

Quick inlet and outlet connectors - 8mm.

Schuko plug

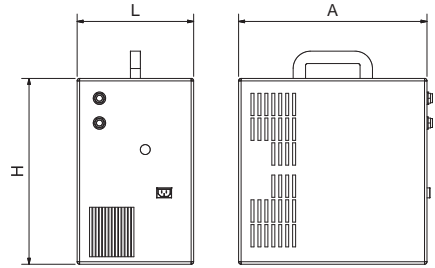

L	A	H	Potencia Power Puissance	Tensión Voltage Tension	Frecuencia Frequency Fréquence	Kg	Barcode	€
235	380	375	125 W	220 V	50 Hz.	17,0	461460	679,00

Accesorios para fuentes M 3/8"

Spare parts for water fountains M 3/8"

Pièces de rechange pour fontaines d'eau M 3/8"



Grifo para fuente de agua sin pulsador
Tap for drinking fountain without push-button
Robinet pour fontaine sans bouton-poussoir

115 464248 35,00



Grifo pulsador para fuente
Push-button tap for fountain
Robinet poussoir pour fontaine

125 464250 25,00



Grifo llena-jarras
Tap to fill up jars
Robinet pour remplir pots

130 464252 23,00



Filtro para fuente de agua fría y caliente Futura
Filter for hot and cold water Futura drinking fountains
Filtre pour fontaines d'eau froide et chaude Futura

1.000 464220 52,00



Filtro para fuente de agua fría y del tiempo Futura
Filter for cold and room temperature water Futura drinking fountains
Filtre pour Fontaines d'eau froide et à température ambiante Futura

1.000 464222 50,00



Filtros para fuentes Cold +
Filter for Cold+ drinking fountains
Filtre pour Cold+ fontaines

1.000 464224 75,00



Cabeza para filtro de fuentes Cold +
Head for filter of Cold+ drinking fountains
Tête pour filtre Cold+ fontaines

1.500 464226 90,00



FREGADEROS

Sinks
Éviers

NOVEDADES

News
Nouveautés

Fregadero portátil automático agua fría Automatic mobile sink with self-contained free standing system, cold water Plonge portable autonome eau froide.....	219
Fregadero portátil automático agua fría y caliente Automatic mobile sink with self-contained free standing system, hot and cold water Plonge portable autonome eau froide et chaude	220
Sumidero sanitario salida vertical Sanitary floor-drainer vertical outlet Égout sanitaire sortie vertical	226
Sumidero sanitario salida horizontal Sanitary floor-drainer horizontal outlet Égout sanitaire sortie horizontale	227



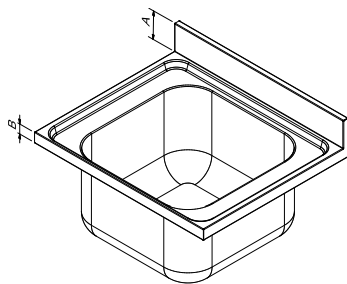

	A	B
Serie 500 Model 500 Série 500	25	25
Serie 550 Model 550 Série 550	100	40
Serie 600 y 700 Model 600 & 700 Série 600 et 700	100	40

Detalle de tubo rebosadero
(Fregaderos de ancho 600 y 700 mm)
Overflow detail. (600 y 700 mm sinks)
Détail de tube-déversoir (profondeur 600 et 700 mm)

Manufacturing characteristics:

Sink units

The wide range of sinks Fricosmos is conceived to the fit in to the best industrial needs: wall-mounted sinks, with support, sliding or hinged doors...

Made in stainless steel.

Totally welded frame that guarantees a higher solidity in comparison to other detachable supports. Legs made in tube 40x40 mm. Models without shelf are reinforced with lower frame.

Frame support set back from the edge of the top to overcome the sanitary rounded corners.

Adjustable feet, for a better stability, since they can be adjusted to any floor unevenness.

Drain valve with plug and overflow in sink units of 500 mm depth. Industrial units (depth 600 and 700 mm.) are provided with pipe-overflow and drain valve.

Optionally, the following accessories can be installed:

Hole to couple tap	196
Drawers	462
Wheels	466
Quick drain valve	224
Knife-holder disinfectant	355
Gastronom containers	412

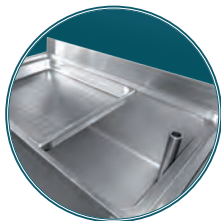

Detalle de rueda de acero inoxidable con freno acoplada a pata de fregadero.

Detail of wheel in stainless steel with brake fixed to leg.

Détail de roue en acier inoxydable avec frein installé dans pied.



Características de fabricación: Fregaderos

La amplia gama de fregaderos Fricosmos esta concebida para adaptarse al máximo a las necesidades industriales, por lo que en nuestro catálogo encontrarán fregaderos colgantes, con soporte, con puertas, etc.

Fabricados en acero inoxidable.

Estructura totalmente soldada que garantiza una mayor solidez frente a otros fregaderos con soportes desmontables. Patas construidas en tubo de 40x40 mm. Los modelos sin entrepaño llevan bastidor inferior de refuerzo.

Soporte desplazado en su parte trasera para salvar la curva sanitaria del suelo.

Pies regulables para favorecer la estabilidad, ya que se adaptan a cualquier desnivel del suelo.

Válvula de desagüe con tapón y rebosadero en modelos de fondo 500 mm. Los modelos industriales (fondo 600 y 700 mm.) se suministran con tubo rebosadero y válvula de desagüe.

Opcionalmente se pueden instalar los siguientes accesorios:

Taladro para acoplar grifo	196
Cajones	462
Ruedas	466
Válvula de descarga rápida	224
Esterilizador de cuchillos	355
Cubetas Gastronorm	412

Caractéristiques de fabrication:

Éviers

L'ample gamme d'éviers Fricosmos est conçue pour sa meilleure adaptation aux besoins industriels. Éviers suspendus, avec support, avec portes à deux battants, coulissantes...

Fabriqués en acier inoxydable.

Châssis totalement soudé. Il permet d'achever plus de solidité par rapport à d'autres éviers avec supports démontables. Pieds construits en tube de 40x40. Les modèles sans tablette-rayon ont du châssis inférieur de renforcement.

Support déplacé dans la partie postérieure pour permettre l'installation des conduits d'eau. En plus il est dessiné pour s'adapter parfaitement à la courbure sanitaire du sol.

Pieds réglables pour favoriser sa stabilité, puisqu'ils s'adaptent à n'importe quel sol.

Écoulement avec tampon et déversoir dans éviers avec 500 mm de profondeur. Les éviers industriels (profondeur 600 et 700 mm) sont fabriqués avec tube-déversoir et écoulement.

On peut installer les suivantes accessoires optionnels:

Trou pour accoupler un robinet	196
Tiroirs	462
Rouelles	466
Valve de rapide drainage	224
Porte-couteaux désinfecteur	355
Bacs Gastronorm	412



Detalle de pata con pie regulable.
Detail of adjustable feet.
Détail de pie réglable.



Características de fabricación:

Fabricados en acero inoxidable.

Las cubetas son de 1 mm de espesor y están acabadas en satinado scotch-brite.

Válvula de desagüe con tapón y rebosadero en modelos redondos, los modelos industriales de 250, 300 y 350 mm se suministran con válvula de desagüe (sin rebosadero), tubo de rebosadero y tapón.



Manufacturing characteristics:

Made in stainless steel.

Tanks have 1 mm. thick and scotch brite matt finish.

Drain valve with plug and overflow in rounded. Industrial models of 250, 300 and 350 mm. depth are provided with drain valve (without overflow).

Caractéristiques de fabrication:

Fabriqués en acier inoxydable.

Les bacs ont 1 mm d'épaisseur avec finition satiné scotch brite.

Valvule d'écoulement avec bonde et déversoir dans models ronds
Les models industriels de 250, 300 et 350 mm son pourvus avec valvule d'écoulement (sans déversoir).

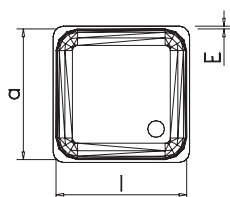
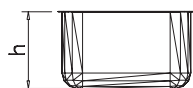
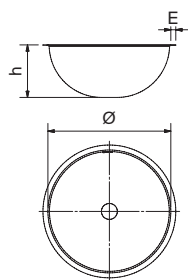

Ø	l	a	h	E	●	●	Kg	Barcode	€
260			115	15			0,70	350624	49,00
390			150	20			1,40	350620	57,00
	370	340	145	20			2,60	350648	75,00
	400	400	250	20			3,71	454018	76,00
	400	400	300	20			4,10	454020	79,00
	500	500	300	20			5,40	454039	105,00
	500	500	350	20			5,63	454041	164,00
	600	450	300	20	●		5,45	454042	164,00
	600	450	300	20	●		5,45	454044	164,00
	600	450	350	20	●		6,11	454045	167,00
	600	450	350	20	●		6,11	454054	167,00
	600	500	300	20	●		5,95	454046	164,00
	600	500	300	20	●		5,95	454048	164,00
	600	500	350	20	●		6,51	454050	171,00
	600	500	350	20	●		6,51	454052	171,00
	800	420	350	20	●		9,51	454004	327,00
	800	420	350	20	●		9,51	454006	327,00
	1.060	420	350	20	●		10,51	454008	370,00
	1.060	420	350	20	●		10,51	454010	370,00

Fregaderos
Sink units
Éviers

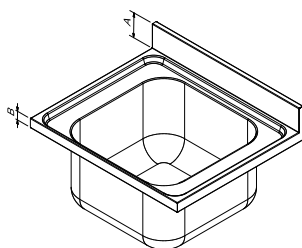

	A	B
Serie 500		
Model 500	25	25
Série 500		
Serie 550		
Model 550	100	40
Série 550		
Serie 600 y 700		
Model 600 & 700	100	40
Série 600 et 700		

L	A	l	a	h	Kg	Barcode	€
450	450	370	340	150	1,85	450603	68,00
450	500	340	370	150	2,10	450604	75,00
600	500	504	403	150	2,95	450606	80,00
600	600	400	500	250	7,50	452200	197,00
700	600	500	500	300	8,35	452202	315,00
700	700	500	500	300	9,00	452602	317,00
800	600	600	500	320	9,00	452204	323,00
800	700	600	500	320	10,00	452604	316,00
1.000	600	860	420	350	14,50	452228	463,00
1.000	700	860	420	350	15,50	452628	474,00
1.200	600	1.060	420	350	16,50	452230	515,00
1.200	700	1.060	420	350	17,50	452630	525,00
1.500	600	1.160	420	600	19,50	453804	726,00
1.500	700	1.160	500	600	20,50	453806	726,00
2.000	600	800	420	600	24,50	453808	1.182,50
2.000	700	800	500	600	25,50	453810	1.182,50
1.300	700	800	500	400	14,00	453602	541,00
1.600	700	950	500	400	18,00	453606	565,00
1.300	700	800	500	400	14,00	453604	541,00
1.600	700	950	500	400	18,00	453608	565,00
800	500	340	370	150	3,10	450616	89,00
1.000	500	340	370	150	3,80	450628	106,00
1.000	550	340	340	200	8,50	452002	221,00
1.000	600	500	500	300	9,00	452206	329,00
1.000	700	500	500	300	10,00	452606	331,00
1.200	600	500	400	250	11,65	452210	257,00
1.200	700	500	400	250	12,65	452610	268,00
1.300	600	500	500	300	12,65	452214	350,00
1.300	700	500	500	300	12,50	452614	352,00
1.400	600	500	500	300	13,00	452218	369,00
1.400	700	600	500	320	14,00	452618	371,00
800	500	340	370	150	3,10	450618	89,00
1.000	500	340	370	150	3,80	450630	106,00
1.000	550	340	340	200	8,50	452004	221,00
1.000	600	500	500	300	9,00	452208	329,00
1.000	700	500	500	300	10,00	452608	331,00
1.200	600	500	400	250	11,65	452212	257,00
1.200	700	500	400	250	12,65	452612	268,00
1.300	600	500	500	300	12,65	452216	350,00
1.300	700	500	500	300	12,50	452616	352,00
1.400	600	500	500	300	13,00	452220	369,00
1.400	700	600	500	320	14,00	452620	371,00

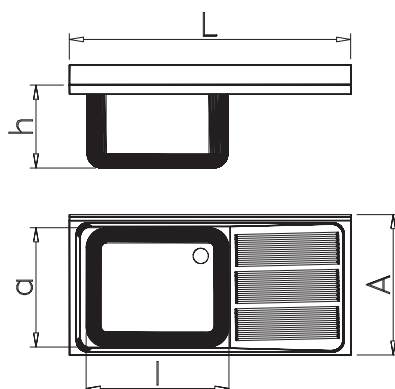

L	A	l	a	h	Kg	Barcode	€
800	500	340	370	150	3,80	450610	135,00
1.000	600	500	400	250	13,00	452222	473,00
1.000	700	500	400	250	14,00	452622	474,00
1.200	600	500	500	300	14,00	452224	495,00
1.200	700	500	500	300	15,00	452624	498,00
1.400	600	500	500	300	18,00	452226	524,00
1.400	700	600	500	320	19,00	452626	550,00



1.200	500	340	370	150	4,85	450636	164,00
1.400	550	400	400	250	14,50	452006	324,00
1.400	600	500	400	250	15,50	452232	477,00
1.400	700	500	400	250	16,50	452632	499,00
1.600	600	500	400	250	18,00	452246	494,00
1.600	700	500	400	250	19,00	452646	502,00
2.000	600	500	500	300	22,50	452240	619,00
2.000	700	600	500	320	23,50	452640	627,00



1.200	500	340	370	150	4,85	450638	164,00
1.400	550	400	400	250	14,50	452008	324,00
1.400	600	500	400	250	15,50	452234	477,00
1.400	700	500	400	250	16,50	452634	499,00
1.600	600	500	400	250	18,00	452248	494,00
1.600	700	500	400	250	19,00	452648	502,00
2.000	600	500	500	300	22,50	452242	619,00
2.000	700	600	500	320	23,50	452642	627,00



2.000	600	500	400	250	22,50	452244	605,00
2.000	700	500	400	250	23,50	452644	606,00



1.800	600	500	400	300	23,00	452250	669,00
1.800	700	500	400	300	25,00	452650	720,00

Fregaderos para encastrar

Built-in sink series
Éviers modèle à intégrer

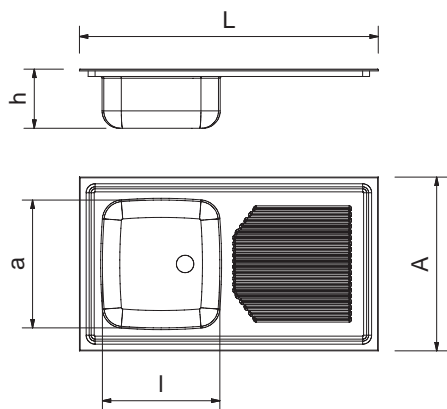
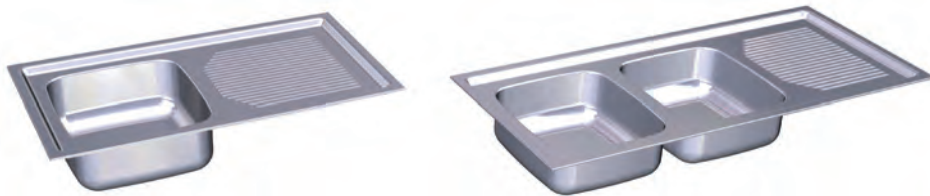

L	A	I	a	h	Kg	Barcode	€
---	---	---	---	---	----	---------	---

860	500	350	400	120	2,50	453202	104,00
-----	-----	-----	-----	-----	------	--------	--------



860	500	350	400	120	2,50	453204	104,00
-----	-----	-----	-----	-----	------	--------	--------



1.160	500	350	400	120	3,50	453206	111,00
-------	-----	-----	-----	-----	------	--------	--------



1.160	500	350	400	120	3,50	453208	111,00
-------	-----	-----	-----	-----	------	--------	--------

Escurreidores de platos y vasos

Plate and glasses racks
Égouttoirs pour assiettes et verres

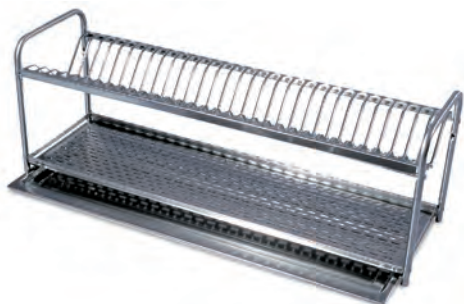

Características:

Bandeja de goteo.
Sólido, estable y de fácil montaje.
Estante inferior perforado para vasos, tazas, etc.

Characteristics:

Leak tray.
Solid, steady and easy to assemble.
Lower perforated shelf for glasses, cups, etc.

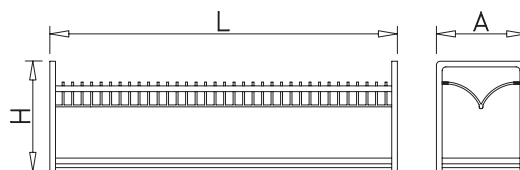

Caractéristiques:
Plateau de dégouttement.
Solide, ferme et facile installation.
Etagère perforée pour verres, tasses, etc.

L	A	H	Barcode	Kg	Barcode	€
---	---	---	---------	----	---------	---

510	240	290	18	1,5	454802	67,00
-----	-----	-----	----	-----	--------	-------

910	240	290	35	2,7	454804	102,00
-----	-----	-----	----	-----	--------	--------

Fregaderos para lavavasos y lavaplatos

Sink units for dishwashers
Éviers pour lave-vaisselles

Características de fabricación:

Fregaderos diseñados para alojar lavavasos o lavaplatos bajo el escurridor.
Fabricados en acero inoxidable.
Pies regulables para una mejor adaptación a la altura de la máquina.
Entrepaño en su base para un mejor aprovechamiento del espacio, pues permite la colocación de cestas y objetos.

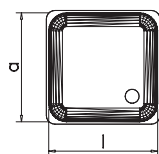
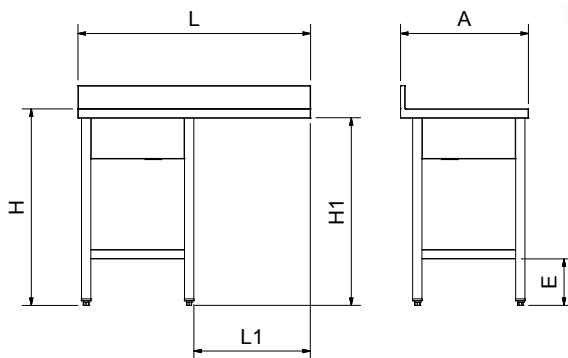

Manufacturing characteristics:













Sink units designed to lodge dishwashers under the drain board.
Made in stainless steel.
Adjustable feet in order to get a better adaptation of the machinery.
Frame with shelf for a better use of space, since it allows to lodge several objects.

Caractéristiques de fabrication:

Éviers dessinés pour loger lave-vaisselles dessus l'égouttoir.
Fabriqué en acier inoxydable.
Pieds réglables pour achever une meilleure adaptation des machines.
Châssis avec tablette-rayon pour profiter l'espace le mieux, puisqu'il permet de loger des objets.

Detalle de instalación.

Installation example.
Exemple d'installation.

							Espacio útil Room Espacement					
L	A	H	E	I	a	h	L1	H1	Kg	Barcode	€	
	1.000	550	850	200	340	340	200	500	810-890	15,0	054230	425,00
	1.200	600	890	200	500	400	250	600	810-890	20,0	054214	439,00
	1.200	700	890	200	500	400	250	600	810-890	24,0	054218	560,00
	1.000	550	850	200	340	340	200	500	810-890	15,0	054232	425,00
	1.200	600	890	200	500	400	250	600	810-890	20,0	054216	439,00
	1.200	700	890	200	500	400	250	600	810-890	24,0	054220	560,00
	1.400	550	850	200	400	400	250	500	810-890	22,0	054234	600,00
	1.600	600	890	200	500	400	250	600	810-890	34,0	054222	810,00
	1.600	700	890	200	500	400	250	600	810-890	36,0	054226	870,00
	1.400	550	850	200	400	400	250	500	810-890	22,0	054236	600,00
	1.600	600	890	200	500	400	250	600	810-890	34,0	054224	810,00
	1.600	700	890	200	500	400	250	600	810-890	36,0	054228	870,00

Fregaderos colgantes con cartelas

Wall mounted sinks with brackets

Plonges inox suspendues avec équerres

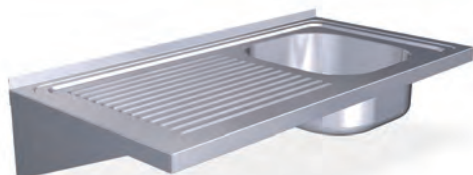
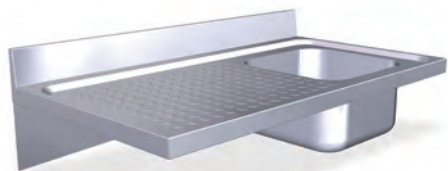

L	A	H	l	a	h	p	b	Kg	Barcode	€
450	500	205	340	370	150	25	25	4,0	057404	140,00
600	500	200	504	403	150	25	25	4,8	057406	133,00
600	600	205	400	500	250	100	40	9,5	057600	255,00
700	600	205	500	500	300	100	40	10,3	057602	374,00
800	600	205	600	500	320	100	40	11,0	057604	382,00



1.000	600	205	860	420	350	100	40	16,5	057628	528,00
1.200	600	205	1.060	420	350	100	40	18,5	057630	582,00



800	500	205	340	370	150	25	25	5,1	057416	156,00
1.000	500	205	340	370	150	25	25	5,8	057428	170,00
1.000	550	205	340	340	200	100	40	10,5	057802	308,00
1.000	600	205	500	400	250	100	40	11,0	057606	388,00
1.200	600	205	500	400	250	100	40	13,6	057610	319,00
1.300	600	205	500	500	300	100	40	14,6	057614	413,00
1.400	600	205	500	500	300	100	40	15,0	057618	432,00



800	500	205	340	370	150	25	25	5,1	057418	156,00
1.000	500	205	340	370	150	25	25	5,8	057430	170,00
1.000	550	205	340	340	200	100	40	10,5	057804	308,00
1.000	600	205	500	400	250	100	40	11,0	057608	388,00
1.200	600	205	500	400	250	100	40	13,6	057612	319,00
1.300	600	205	500	500	300	100	40	14,6	057616	413,00
1.400	600	205	500	500	300	100	40	15,0	057620	432,00

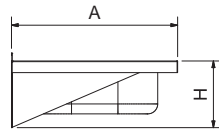
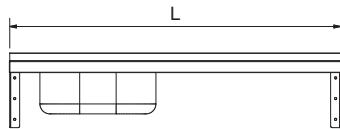
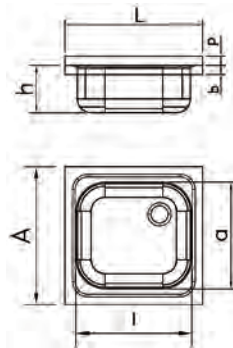
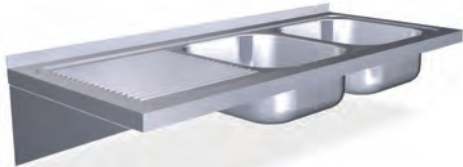
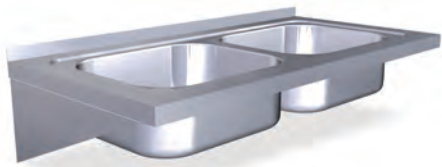

L	A	H	l	a	h	p	b	Kg	Barcode	€
800	500	205	340	370	150	25	25	5,8	057410	202,00
1.000	600	205	400	500	250	100	40	15,0	057622	536,00
1.200	600	205	500	500	300	100	40	16,0	057624	559,00
1.400	600	205	600	500	300	100	40	20,0	057626	592,00
1.200	500	205	340	370	150	25	25	6,8	057436	234,00
1.400	550	205	400	400	250	100	40	16,5	057806	389,00
1.400	600	205	500	400	250	100	40	17,5	057632	543,00
1.200	500	205	340	370	150	25	25	6,8	057438	234,00
1.400	550	205	400	400	250	100	40	16,5	057808	389,00
1.400	600	205	500	400	250	100	40	17,5	057634	543,00



Fregaderos colgantes con faldón y palomillas

Wall-mounted sink units with skirt and brackets

Éviers suspendus avec habillage et barres de fixation

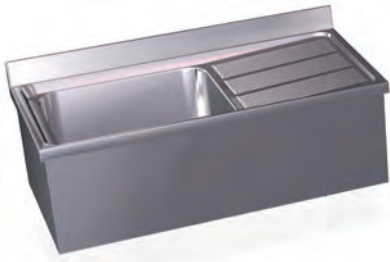

							Fregaderos con faldón Sink units with skirt Éviers avec habillage			Fregaderos con palomillas Sink units with brackets Éviers avec barres de fixation		
L	A	H	H1	I	a	h	Kg	Barcode	€	Kg	Barcode	€
450	450	200	450	370	340	150	4,1	050202	163,00	7,0	050402	334,00
450	500	200	450	340	370	150	5,4	050204	304,00	7,6	050404	334,00
600	500	200	450	504	403	150	6,6	050206	327,00	9,0	050406	361,00
600	600	250	450	400	500	250	13,5	054400	500,00	14,8	054600	565,00
700	600	300	450	500	500	300	14,8	054402	612,00	16,0	054602	676,00
700	700	300	450	500	500	300	15,9	055602	650,00	16,6	055802	718,00
800	600	320	450	600	500	320	16,1	054404	639,00	17,2	054604	707,00
800	700	320	450	600	500	320	17,7	055604	676,00	19,1	055804	750,00
1.000	600	340	450	860	420	350	14,5	054428	904,00	25,1	054628	1.005,00
1.000	700	340	450	860	420	350	15,5	055628	940,00	27,3	055828	1.048,00
1.200	600	340	450	1.060	420	350	16,5	054430	1.017,00	29,4	054630	1.130,00
1.200	700	340	450	1.060	420	350	17,5	055630	1.050,00	31,8	055830	1.169,00
800	500	200	450	340	370	150	8,0	050216	344,00	9,9	050416	379,00
1.000	500	200	450	340	370	150	9,3	050228	348,00	11,3	050428	384,00
1.000	600	300	450	500	500	300	16,5	054406	678,00	18,0	054606	751,00
1.000	700	300	450	500	500	300	18,2	055606	714,00	20,1	055806	791,00
1.200	600	300	450	500	400	250	19,9	054410	646,00	21,5	054610	721,00
1.200	700	300	450	500	400	250	21,6	055610	685,00	23,8	055810	767,00
1.300	600	300	450	500	500	300	21,2	054414	753,00	23,0	054614	829,00
1.300	700	300	450	500	500	300	21,8	055614	791,00	24,2	055814	872,00
1.400	600	320	450	600	500	320	22,3	054418	791,00	23,8	054618	872,00
1.400	700	320	450	600	500	320	24,0	055618	825,00	26,2	055818	914,00
800	500	200	450	340	370	150	8,0	050218	344,00	9,9	050418	379,00
1.000	500	200	450	340	370	150	9,3	050230	348,00	11,3	050430	384,00
1.000	600	300	450	500	500	300	16,5	054408	678,00	18,0	054608	751,00
1.000	700	300	450	500	500	300	18,2	055608	714,00	20,1	055808	791,00
1.200	600	300	450	500	400	250	19,9	054412	646,00	21,5	054612	721,00
1.200	700	300	450	500	400	250	21,6	055612	685,00	23,8	055812	767,00
1.300	600	300	450	500	500	300	21,2	054416	753,00	23,0	054616	829,00
1.300	700	300	450	500	500	300	21,8	055616	791,00	24,2	055816	872,00
1.400	600	320	450	600	500	320	22,3	054420	791,00	23,8	054620	872,00
1.400	700	320	450	600	500	320	24,0	055620	825,00	26,2	055820	914,00

Fregaderos colgantes con faldón y palomillas

Wall-mounted sink units with skirt and brackets
Éviers suspendus avec habillage et barres de fixation

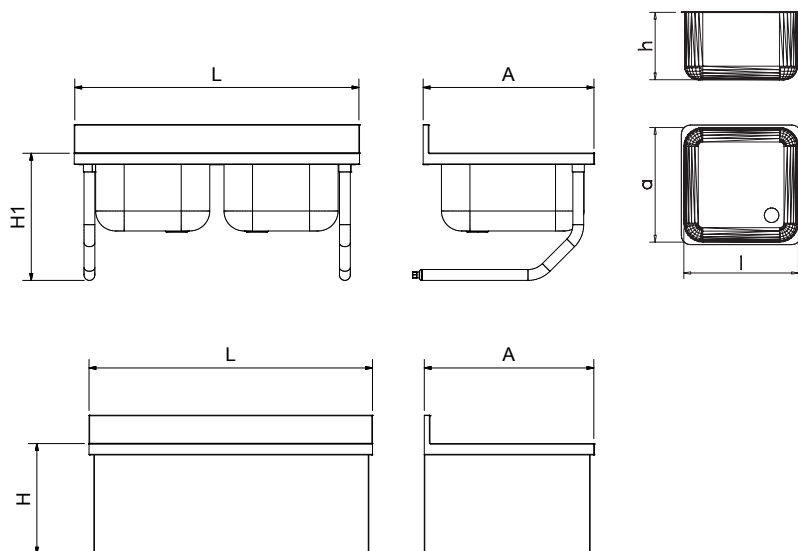

							Fregaderos con faldón Sink units with skirt Éviers avec habillage			Fregaderos con palomillas Sink units with brackets Éviers avec barres de fixation		
L	A	H	H1	l	a	h	Kg	Barcode	€	Kg	Barcode	€
800	500	200	450	340	370	150	8,7	050210	403,00	10,6	050410	446,00
1.000	600	250	450	400	500	250	19,8	054422	863,00	21,8	054622	955,00
1.000	700	250	450	400	500	250	21,4	055622	901,00	23,9	055822	996,00
1.200	600	300	450	500	500	300	22,2	054424	913,00	23,9	054624	1.010,00
1.200	700	300	450	500	500	300	23,9	055624	950,00	26,1	055824	1.052,00
1.400	600	320	450	600	500	320	27,3	054426	964,00	28,8	054626	1.066,00
1.400	700	320	450	600	500	320	29,0	055626	1.000,00	31,2	055826	1.108,00



1.200	500	200	450	340	370	150	10,9	050236	434,00	13,1	050436	479,00
1.400	600	250	450	500	400	250	23,6	054432	905,00	26,1	054632	1.002,00
1.400	700	250	450	500	400	250	25,2	055632	943,00	28,1	055832	1.044,00
1.600	600	320	450	500	400	250	29,0	054446	1.027,00	32,0	054646	1.174,00
1.600	700	320	450	500	400	250	30,0	055646	1.065,00	34,0	055846	1.189,00
2.000	600	320	450	600	500	320	34,0	054440	1.199,00	36,0	054640	1.325,00
2.000	700	320	450	600	500	320	35,8	055640	1.235,00	38,8	055840	1.367,00



1.200	500	200	450	340	370	150	10,9	050238	434,00	13,1	050438	479,00
1.400	600	250	450	500	400	250	23,6	054434	905,00	26,1	054634	1.002,00
1.400	700	250	450	500	400	250	25,2	055634	943,00	28,1	055834	1.044,00
1.600	600	320	450	500	400	250	29,0	054448	1.027,00	32,0	054648	1.174,00
1.600	700	320	450	500	400	250	30,0	055648	1.065,00	34,0	055848	1.189,00
2.000	600	320	450	600	500	320	34,0	054442	1.199,00	36,0	054642	1.325,00
2.000	700	320	450	600	500	320	35,8	055642	1.235,00	38,8	055842	1.367,00



2.000	600	250	450	500	400	250	32,5	054444	1.168,00	35,7	054644	1.292,00
2.000	700	250	450	500	400	250	34,3	055644	1.206,00	38,6	055844	1.334,00

Fregaderos con soporte

Floor-mounted sink units
Éviers avec support



Válido para lavavasos.
Valid for glass washers.
Valide pour machines à laver verres.



Válido para lavaplatos.
Valid for dish washers.
Valide pour machines à laver assiettes.



						Fregaderos con soporte Sink units with stand Éviers avec support			Fregaderos c/ soporte y entrepaño Sink units with stand and shelf Éviers avec support et tablette		
L	A	H	l	a	h	Kg	Barcode	€	Kg	Barcode	€
450	450	850	370	340	150	10,1	050602	301,00	11,2	050802	371,00
450	500	850	340	370	150	10,5	050604	301,00	11,7	050804	371,00
600	500	850	504	403	150	12,1	050606	338,00	13,5	050806	417,00
600	600	850	400	500	250	17,3	054800	466,00	18,9	055000	574,00
700	600	850	500	500	300	18,5	054802	556,00	20,3	055002	709,00
700	700	850	500	500	300	18,6	056002	610,00	20,7	056202	769,00
800	600	850	600	500	320	19,7	054804	634,00	21,7	055004	783,00
800	700	850	600	500	320	21,2	056004	620,00	28,4	056204	782,00
1.000	600	850	860	420	350	22,0	054828	790,00	28,0	055028	1.007,00
1.000	700	850	860	420	350	24,0	056028	978,00	30,0	056228	1.207,00
1.200	600	850	1.060	420	350	26,0	054830	850,00	34,0	055030	1.082,00
1.200	700	850	1.060	420	350	28,0	056030	1.038,00	46,0	056230	1.282,00
1.300	700	850	800	500	400	28,2	053602	840,00			
1.600	700	850	950	500	400	36,7	053606	960,00			
1.300	700	850	800	500	400	28,2	053604	840,00			
1.600	700	850	950	500	400	36,7	053608	960,00			
800	500	850	340	370	150	13,2	050616	342,00	15,0	050816	451,00
1.000	500	850	340	370	150	14,9	050628	350,00	17,1	050828	467,00
1.000	550	850	340	340	200	17,5	051802	489,00	23,0	052002	582,00
1.000	600	850	500	500	300	20,8	054806	550,00	23,2	055006	676,00
1.000	700	850	500	500	300	22,4	056006	600,00	25,0	056206	740,00
1.200	600	850	500	400	250	24,5	054810	528,00	27,3	055010	663,00
1.200	700	850	500	400	250	26,2	056010	575,00	29,3	056210	766,00
1.300	600	850	500	500	300	26,0	054814	656,00	29,0	055014	797,00
1.300	700	850	500	500	300	26,7	056014	686,00	29,9	056214	833,00
1.400	600	850	600	500	320	26,9	054818	684,00	30,1	055018	837,00
1.400	700	850	600	500	320	28,7	056018	715,00	32,2	056218	873,00
800	500	850	340	370	150	13,2	050618	342,00	15,0	050818	451,00
1.000	500	850	340	370	150	14,9	050630	350,00	17,1	050830	467,00
1.000	550	850	340	340	200	17,5	051804	489,00	23,0	052004	582,00
1.000	600	850	500	500	300	20,8	054808	550,00	23,2	055008	676,00
1.000	700	850	500	500	300	22,4	056008	600,00	25,0	056208	740,00
1.200	600	850	500	400	250	24,5	054812	528,00	27,3	055012	663,00
1.200	700	850	500	400	250	26,2	056012	575,00	29,3	056212	766,00
1.300	600	850	500	500	300	26,0	054816	656,00	29,0	055016	797,00
1.300	700	850	500	500	300	26,7	056016	686,00	29,9	056216	833,00
1.400	600	850	600	500	320	26,9	054820	684,00	30,1	055020	837,00
1.400	700	850	600	500	320	28,7	056020	715,00	32,2	056220	873,00

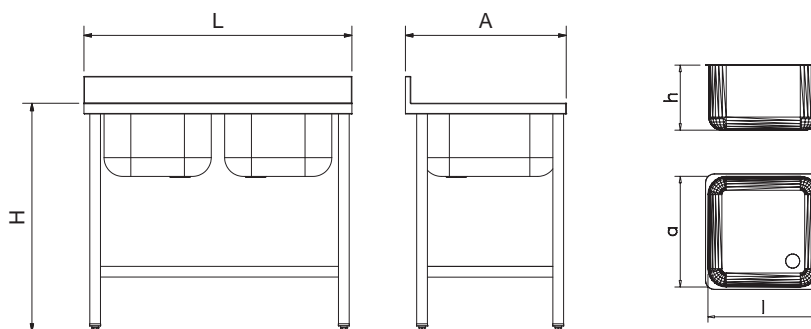

						Fregaderos con soporte Sink units with stand Éviers avec support	Fregaderos c/ soporte y entrepaño Sink units with stand and shelf Éviers avec support et tablette					
L	A	H	l	a	h	Kg	Barcode	€	Kg	Barcode	€	
800	500	850	340	370	150	13,9	050610	411,00	15,7	050810	520,00	
1.000	600	850	500	400	250	24,8	054822	780,00	27,2	055022	906,00	
1.000	700	850	500	400	250	26,4	056022	810,00	29,0	056222	941,00	
1.200	600	850	500	500	300	26,8	054824	850,00	29,6	055024	987,00	
1.200	700	850	500	500	300	28,6	056024	880,00	31,6	056224	1.022,00	
1.400	600	850	600	500	320	31,9	054826	900,00	35,1	055026	1.053,00	
1.400	700	850	600	500	320	33,7	056026	930,00	37,2	056226	1.090,00	
1.200	500	850	340	370	150	17,0	050636	458,00	19,5	050836	553,00	
1.400	550	850	400	400	250	21,0	051806	665,00	25,0	052006	745,00	
1.400	600	850	500	400	250	29,4	054832	830,00	32,6	055032	983,00	
1.400	700	850	500	400	250	31,2	056032	850,00	34,7	056232	1.008,00	
1.600	600	850	500	400	250	33,4	054846	946,00	40,5	055046	1.035,00	
1.600	700	850	500	400	250	35,2	056046	988,00	42,5	056246	1.092,00	
2.000	600	850	600	500	320	39,7	054840	950,00	44,6	055040	1.130,00	
2.000	700	850	600	500	320	41,8	056040	1.170,00	46,5	056240	1.355,00	
1.200	500	850	340	370	150	17,0	050638	458,00	19,5	050838	553,00	
1.400	550	850	400	400	250	21,0	051808	665,00	25,0	052008	745,00	
1.400	600	850	500	400	250	29,4	054834	830,00	32,6	055034	983,00	
1.400	700	850	500	400	250	31,2	056034	850,00	34,7	056234	1.008,00	
1.600	600	850	500	400	250	33,4	054848	946,00	40,5	055048	1.035,00	
1.600	700	850	500	400	250	35,2	056048	988,00	42,5	056248	1.092,00	
2.000	600	850	600	500	320	39,7	054842	950,00	44,6	055042	1.130,00	
2.000	700	850	600	500	320	41,8	056042	1.170,00	46,5	056242	1.355,00	
2.000	600	850	500	400	250	39,7	054844	1.050,00	44,0	055044	1.231,00	
2.000	700	850	500	400	250	41,8	056044	1.080,00	46,5	056244	1.266,00	
1.800	600	850	500	400	300	45,0	054850	1.248,00				
1.800	700	850	500	400	300	50,0	056050	1.300,00				

Fregaderos con puertas de corredera y abatibles

Sink units with sliding and hinged doors

Éviers à portes coulissantes et à portes à deux battants



Características:

Laterales forrados en acero inoxidable. Entrepaño a 200 mm del suelo. Puertas colgadas, lo que evita depósitos de suciedad y entrepaño. Escurridor inclinado.

Characteristics:

Sides lined in stainless steel. Hanging doors. They avoid dirtiness deposits in rails and shelves. Undershef at 200 mm. from the floor.

Caractéristiques:

Latérales recouvertes en acier inoxydable. Portes sont suspendues pour éviter des dépôts de saleté dans les rails et dans les tablettes-rayons. Tablette à 200 mm. du sol.



						Fregaderos con puertas correderas Sink units with sliding doors Éviers à portes coulissantes			Fregaderos con puertas abatibles Sink units with hinged doors Éviers à portes à deux battants		
L	A	H	l	a	h	Kg	Barcode	€	Kg	Barcode	€
450	450	850	370	340	150				14,0	051202	932,00
450	500	850	340	370	150				16,0	051204	941,00
600	500	850	504	403	150				21,5	051206	948,00
600	600	850	400	500	250				27,6	055400	995,00
700	600	850	500	500	300				30,1	055402	1.199,00
700	700	850	500	500	300				32,3	056602	1.217,00
800	600	850	600	500	320	28,8	055204	1.145,00	22,6	055404	1.279,00
800	700	850	600	500	320	32,0	056404	1.399,00	35,8	056604	1.565,00
1.000	600	850	860	420	350	36,0	055228	1.284,00	40,0	055428	1.444,00
1.000	700	850	860	420	350	40,0	056428	1.488,00	44,0	056628	1.671,00
1.200	600	850	1.060	420	350	43,0	055230	1.563,00	50,0	055430	1.755,00
1.200	700	850	1.060	420	350	46,0	056430	1.739,00	54,0	056630	1.952,00
800	500	850	340	370	150	21,8	051016	858,00	25,6	051216	959,00
1.000	500	850	340	370	150	25,7	051028	900,00	29,5	051228	1.003,00
1.000	600	850	500	500	300	32,2	055206	1.151,00	36,0	055406	1.285,00
1.000	700	850	500	500	300	35,8	056406	1.353,00	39,6	056606	1.515,00
1.200	600	850	500	400	250	37,2	055210	1.157,00	41,0	055410	1.304,00
1.200	700	850	500	400	250	41,0	056410	1.314,00	44,8	056610	1.480,00
1.300	600	850	500	500	300	40,8	055214	1.324,00	46,5	055414	1.479,00
1.300	700	850	500	500	300	43,7	056414	1.489,00	49,4	056614	1.667,00
1.400	600	850	600	500	320	42,3	055218	1.418,00	48,0	055418	1.585,00
1.400	700	850	600	500	320	46,5	056418	1.594,00	52,2	056618	1.782,00
800	500	850	340	370	150	21,8	051018	858,00	25,6	051218	959,00
1.000	500	850	340	370	150	25,7	051030	867,00	29,5	051230	970,00
1.000	600	850	500	500	300	32,2	055208	1.151,00	36,0	055408	1.285,00
1.000	700	850	500	500	300	35,8	056408	1.353,00	39,6	056608	1.515,00
1.200	600	850	500	400	250	37,2	055212	1.157,00	41,0	055412	1.304,00
1.200	700	850	500	400	250	41,0	056412	1.314,00	44,8	056612	1.480,00
1.300	600	850	500	500	300	40,8	055216	1.324,00	46,5	055416	1.479,00
1.300	700	850	500	500	300	43,7	056416	1.489,00	49,4	056616	1.667,00
1.400	600	850	600	500	320	42,3	055220	1.418,00	48,0	055420	1.585,00
1.400	700	850	600	500	320	46,5	056420	1.594,00	52,2	056620	1.782,00

Fregaderos con puertas de corredera y abatibles

Sink units with sliding and hinged doors
Éviers à portes coulissantes et à portes à deux battants

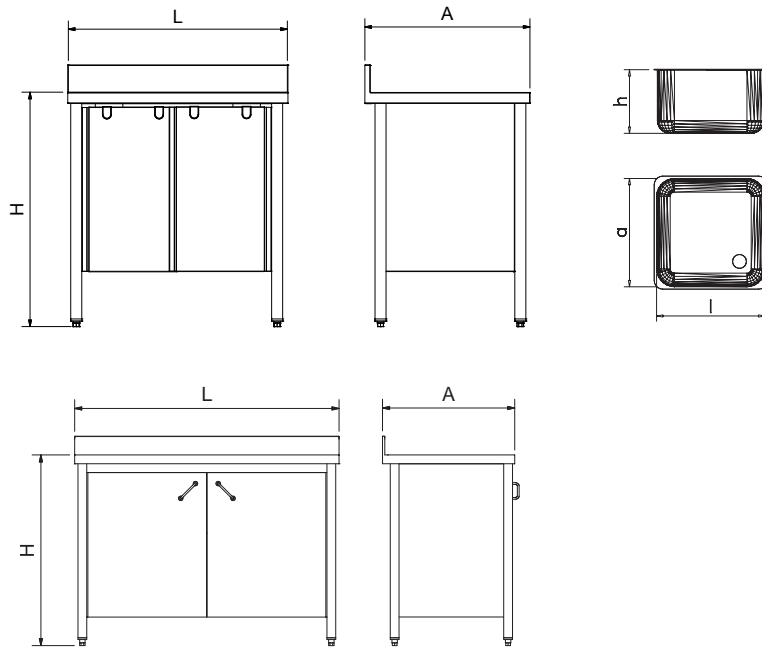

							Fregaderos c/ puertas correderas Sink units with sliding doors Éviers à portes coulissantes			Fregaderos c/ puertas abatibles Sink units with hinged doors Éviers à portes à deux battants		
L	A	H	l	a	h	Kg	Barcode	€	Kg	Barcode	€	
800	500	850	340	370	150	25,5	051010	892,00	26,3	051210	997,00	
1.000	600	850	500	400	250	36,0	055222	1.284,00	39,8	055422	1.436,00	
1.000	700	850	500	400	250	39,6	056422	1.488,00	43,4	056622	1.663,00	
1.200	600	850	500	500	300	39,4	055224	1.375,00	43,2	055424	1.538,00	
1.200	700	850	500	500	300	43,3	056424	1.527,00	47,1	056624	1.708,00	
1.400	600	850	600	500	320	47,1	055226	1.543,00	52,8	055426	1.726,00	
1.400	700	850	600	500	320	51,2	056426	1.720,00	56,9	056626	1.923,00	
1.200	500	850	340	370	150	22,3	051036	987,00	26,1	051236	1.003,00	
1.400	600	850	500	400	250	44,7	055232	1.501,00	50,4	055432	1.679,00	
1.400	700	850	500	400	250	48,9	056432	1.679,00	54,6	056632	1.877,00	
1.600	600	850	500	400	250	52,0	055246	1.823,00	57,0	055446	2.052,00	
1.600	700	850	500	400	250	56,0	056446	2.046,00	61,5	056646	2.300,00	
2.000	600	850	600	500	320	60,7	055240	2.106,00	68,3	055440	2.355,00	
2.000	700	850	600	500	320	65,8	056440	2.353,00	73,4	056640	2.631,00	
1.200	500	850	340	370	150	22,3	051038	987,00	26,1	051238	1.003,00	
1.400	600	850	500	400	250	44,7	055234	1.501,00	50,4	055434	1.679,00	
1.400	700	850	500	400	250	48,9	056434	1.679,00	54,6	056634	1.877,00	
1.600	600	850	500	400	250	52,0	055248	1.823,00	57,0	055448	2.052,00	
1.600	700	850	500	400	250	56,0	056448	2.046,00	61,5	056648	2.300,00	
2.000	600	850	600	500	320	60,7	055242	2.106,00	68,3	055442	2.355,00	
2.000	700	850	600	500	320	65,8	056442	2.353,00	73,4	056642	2.631,00	
2.000	600	850	500	400	250	60,7	055244	2.168,00	68,3	055444	2.424,00	
2.000	700	850	500	400	250	65,8	056444	2.332,00	73,4	056644	2.607,00	

Fregaderos autónomos con una cubeta y escurridor

Mobile and autonomous sink 1 tank and drain board
Plonge autonome avec égouttoir



Características:

Totamente contruidos en acero inoxidable.

Sistema autónomo que no precisa instalación de tomas de agua, desagüe e instalación eléctrica.

Funciona mediante un pedal hidráulico que bombea el agua limpia de un depósito de 20 litros, que se encuentra dentro del armario, al caño superior.

El agua desagua en el otro depósito situado bajo la cubeta del fregadero.

Dispone de sistema anti olores.

El mueble va cerrado por los dos laterales y por el frontal con las puertas correderas.

La parte trasera va abierta.

Dispone de dos ruedas con freno y dos sin freno para facilitar el transporte e inmovilizarlo una vez se encuentre en su ubicación.

Ideal para lugares donde:

No hay tomas de agua

No hay desagüe

No hay instalación eléctrica

Perfecto para eventos al aire libre, ferias, exposiciones, mercadillos, etc.

Characteristics:

Fully made of stainless steel.

Autonomous system which makes any water inlet, drainpipe or electrics unnecessary.

It works by means of a hydraulic push-button which pumps clean water from a 20 litre, water tank that is located inside of the cabinet, to the upper spout.

With anti odor system.

The cabinet is closed on two sides and on the front with the sliding doors.

With four wheels, two of them with brakes to make easy to move around and safely fix.

Ideal for places where:

There is no water connection

There is no drain connection

There is no electrical installation

Perfect for outdoor events, market places, fairs, snack bars, etc.

Caractéristiques:

Totamente fabriqué en acier inoxydable.

Système autonome qui ne précise pas de prise d'eau d'entrée ni déversoir, ni d'installation électrique.

Il fonctionne avec poussoir hydraulique qui pompe l'eau propre d'un réservoir de 20 litres, situé à l'intérieur de l'armoire, au tuyau supérieur.

L'autre réservoir est pour l'eau sale, situé sous la bac de la plonge.

Il dispose d'un système anti-odeurs.

L'armoire est fermée latéralement et frontalement avec des portes coulissantes.

La partie arrière est ouverte.

Il dispose de deux roulettes avec frein et deux sans frein pour faciliter son transport et l'immobiliser.

Conçu spécialement pour les lieux où:

Il n'y a pas de prises d'eau

Il n'a pas de déversoirs

Il n'a pas d'installation électrique

Parfait pour les événements en plein air, foires, expositions, marchés, etc.

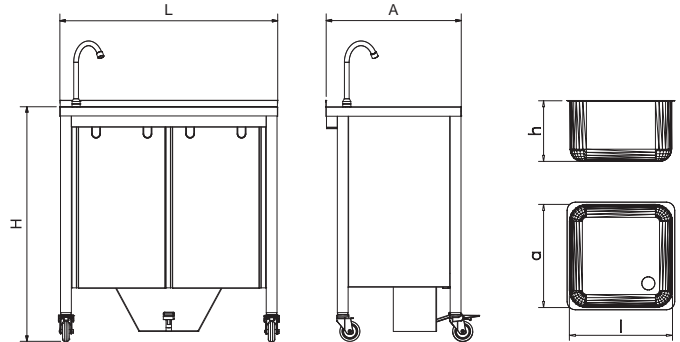

L	A	H	I	a	h				€
800	500	850	340	370	150	2	25	054210	1.100,00
800	500	850	340	370	150	2	25	054212	1.100,00

Opción de agua caliente para fregaderos autónomos Optional hot water for mobile sink Eau chaude optionnelle pour plonge autonome

	Potencia Power Puissance	Tensión Voltage Tension	Frecuencia Frequency Fréquence		€
75°C	2.000 W	220 V	50/60 Hz	054206	178,00

Fregadero portátil automático agua fría

Automatic mobile sink with self-contained free standing system, cold water
Plonge portable autonome eau froide

Características:

Autónomo, no precisa de tomas de agua ni desagüe.
Ruedas para transporte.
Necesita conexión eléctrica.
Depósito de agua de 20 lts.
Sistema antiolores.
Laterales y frontal con puertas correderas.
Trasera abierta.
Grifo giratorio un agua 1/4 vuelta caño alto 463434.

Characteristics:

Self-contained system, which makes unnecessary any water inlet or drainpipe
Wheeled transport
Electricity connection required
20 l water tank
Anti-odour system
The cabinet is closed on two sides and on the front with the sliding doors.
Cabinet with open back.
Single inlet 1/4 turn rotating tap, elevated model 463434

Caractéristiques:

Autonome, il ne nécessite pas de raccords d'eau ou de drainage.
Roues pour le transport.
Nécessite une connexion électrique.
Réservoir d'eau de 20 lts.
Système anti-odeur
Latéral et frontal avec des portes coulissantes.
Arrière ouverte.
Robinet Giratoire une eau 1/4 de tour bec haut 463434.



Novedad
ew
ouveau



Incluido grifo giratorio un agua 1/4 vuelta caño alto 463434.
Included single inlet 1/4 turn rotating tap, elevated model 463434.
Inclus robinet Giratoire une eau 1/4 de tour bec haut 463434.

250

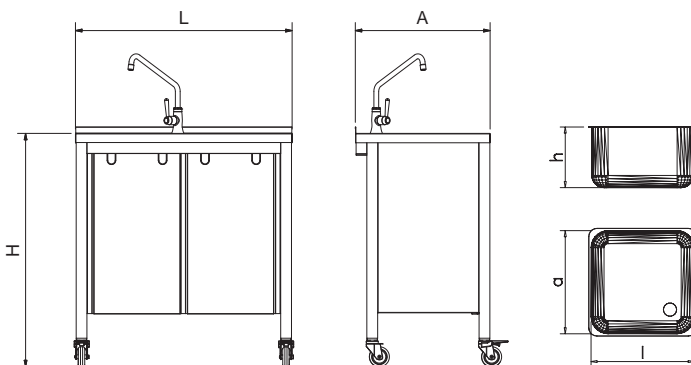

L	A	H	l	a	h	Potencia Power Puissance	Tensión Voltage Tension	Frecuencia Frequency Fréquence	Kg		€	
800	500	865	340	370	150	3,8	60 W	220 V	50/60 Hz	28	054240	1.185,00
800	500	865	340	370	150	3,8	60 W	220 V	50/60 Hz	28	054242	1.185,00

Fregadero portátil automático agua fría y caliente

Automatic mobile sink with self-contained free standing system, hot and cold water
Plonge portable autonome eau froide et chaude



Novedad
New
nouveau

Características:

Autónomo, no precisa de tomas de agua ni desagüe.
Ruedas para transporte.
Necesita conexión eléctrica.
Depósito de agua de 20 lts.
Sistema antiolores.
Laterales y frontal con puertas correderas.
Trasera abierta.
Grifo monomando codo dos aguas 463204.
Termo 10 lts 454262.

Characteristics:

Self-contained system, which makes unnecessary any water inlet or drainpipe
Wheeled transport
Electricity connection required
20 l water tank
Anti-odour system
The cabinet is closed on two sides and on the front with the sliding doors.
Cabinet with open back.
Double inlet one handle tap elbow functioning 463204
10 l water heater 454262

Caractéristiques:

Autonome, il ne nécessite pas de raccordements d'eau ou de drainage.
Roues pour le transport.
Nécessite une connexion électrique.
Réservoir d'eau de 20 lts.
Système anti-odeur
Latéral et frontal avec des portes coulissantes.
Arrière ouverte.
Mitigeur monocommande coude 2 eaux 463204.
Thermo 10 lts 454262.



Incluido grifo monomando codo dos aguas 463204.

Included double inlet one handle tap elbow functioning 463204.
Inclus mitigeur monocommande coude 2 eaux 463204.



247

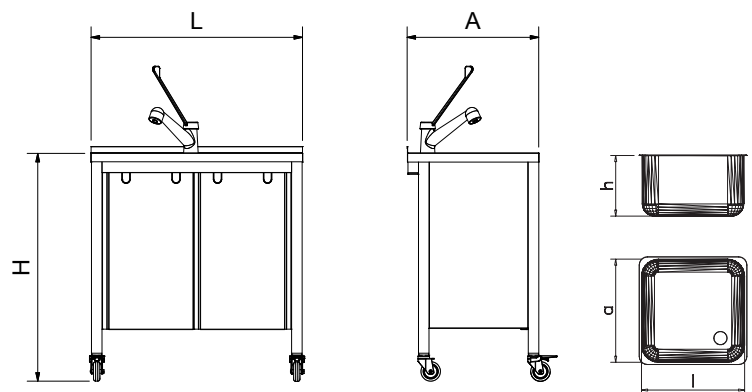

L	A	H	I	a	h	°C max	l/min	Potencia Power Puissance	Tensión Voltage Tension	Frecuencia Frequency Fréquence	Kg	Barcode	€
---	---	---	---	---	---	--------	-------	--------------------------	-------------------------	--------------------------------	----	---------	---



800 500 865 340 370 150 75°C 3,8 2.060 W 220 V 50/60 Hz 33 054244 **1.460,00**



800 500 865 340 370 150 75°C 3,8 2.060 W 220 V 50/60 Hz 33 054246 **1.460,00**

Fregaderos de gran capacidad una cubeta

Large capacity single sink unit
Éviers à grande capacité une bac

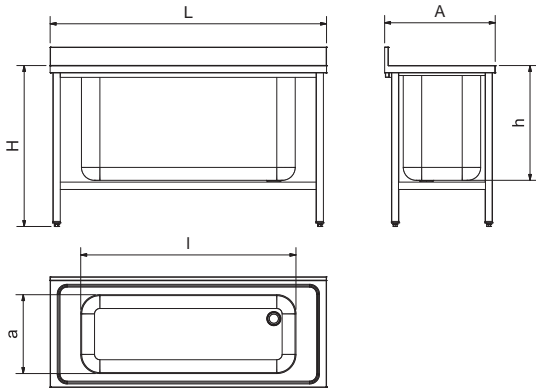

Characteristics:
Wholly made of stainless steel.
1 mm thick plate.
Top with water-safe edge.

Caractéristiques:
Totalemnt en acier inoxydable.
Plaque de 1 mm d'épaisseur.
Partie supérieure avec rebord contre écoulement d'eau.

Características:
Totalmente construido en acero inoxidable.
Chapa de 1 mm de espesor.
Encimera con reborde salva-aguas.

L	A	H	I	a	h	Kg	Barcode	€
1.000	600	850	860	420	350	22	054828	833,00
1.200	600	850	1.060	420	350	26	054830	899,00
1.500	600	850	1.160	420	600	31	053812	1.126,00
1.000	700	850	860	420	350	24	056028	880,00
1.200	700	850	1.060	420	350	28	056030	934,00
1.500	700	850	1.160	500	600	34	053824	1.157,00



Como opción se ofrecen válvulas de descarga rápida.
Possibility of assembly quick drain valve.
Possibilité d'accoupler valvule pour drainage rapide.



224

Fregaderos de gran capacidad dos cubetas

Large capacity double sink units
Éviers à grande capacité deux bacs

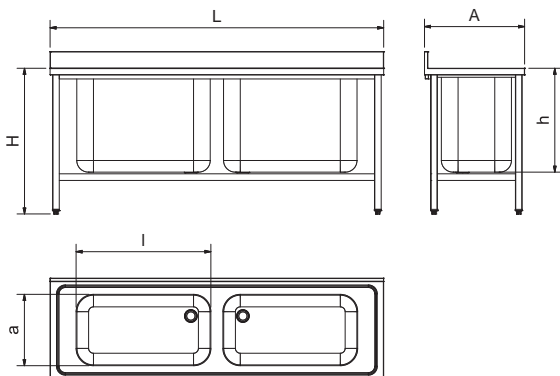

Characteristics:
Wholly made of stainless steel.
1 mm thick plate.
Top with water-safe edge.

Caractéristiques:
Totalemnt en acier inoxydable.
Plaque de 1 mm d'épaisseur.
Partie supérieure avec rebord contre écoulement d'eau.

Características:
Totalmente en acero inoxidable.
Chapa de 1 mm de espesor.
Encimera con reborde salva-aguas.

L	A	H	I	a	h	Kg	Barcode	€
2.000	600	850	800	420	600	42	054018	1.700,00
2.000	700	850	800	500	600	48	054036	1.800,00



Como opción se ofrecen válvulas de descarga rápida.
Possibility of assembly quick drain valve.
Possibilité d'accoupler valvule pour rapide drainage.



224

Fregadero vertedero

Sink-drain
Éviers-déversoir



Características:

Totamente construido en acero inoxidable.
Bastidor soldado, construido en tubo de 40x40 mm que garantiza una máxima solidez y resistencia al peso de grandes ollas y cubos.
Encimera con reborde salva-aguas.

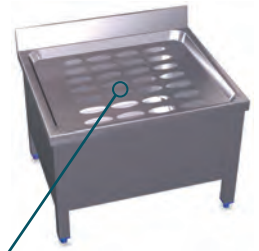

Tapa soporte para cubos y ollas.
Sheet-support for pots and buckets.
Plaque-support pour pots et seaux.

054209 € 103,00

L 620 mm. A 520 mm.

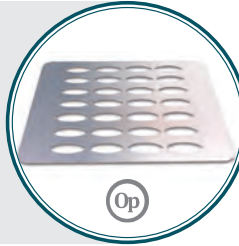

Op Opcional / Optional / Optionnel

Characteristics:

Wholly made of stainless steel.
Welded frame, made in tube 40x40, which guarantees the highest stability and solidity for the weight of big pots and buckets.
Top with water-safe edge.

Caractéristiques:

Totalemen en acier inoxydable.
Structure soudée, fabriqué en tube 40x40, lequel garantit la meilleure stabilité et solidité pour le poids des grands pots et seaux.
Partie supérieure avec rebord contre écoulement d'eau.

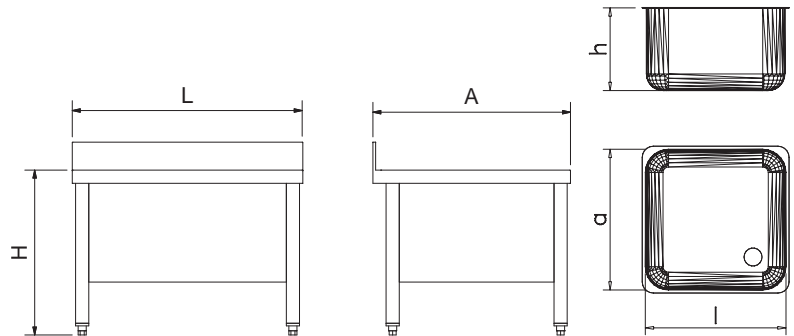

L	A	H	I	a	h	Kg	Barcode	€
700	600	550	500	500	300	16	054208	645,00

Fregadero especial para escayolas

Sink unit with integral sump. Specially for plaster preparation
Évier avec bouche intégré. Spécial pour la préparation des plâtres

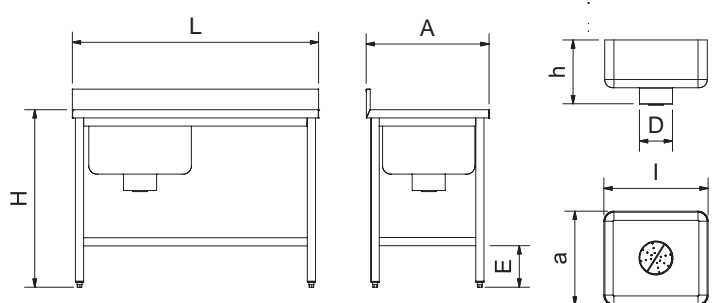

L	A	H	I	a	D	h	E	Kg	Barcode	€
1.200	600	850	500	450	160	380	200	24	076202	1.190,00
1.200	600	850	500	450	160	380	200	24	076204	1.190,00

Calentador de agua instantáneo

Instant water heater
Chauffe-eau instantané



Características principales:

Diseñado para proporcionar agua caliente a un solo fregadero. Calienta el agua mediante su paso por un serpentín eléctrico.

Main characteristics:

It is designed to provide instantaneous hot water to one skin, by means of an electric coil.

Caractéristiques principales:

Il est conçu pour fournir de l'eau chaude instantanée au évier, au moyen d'une bobine électrique.

Temperatura de salida del agua de 35° a 50°

Leaving water temperature 35° - 50°
Température de sortie d'eau 35° - 50°

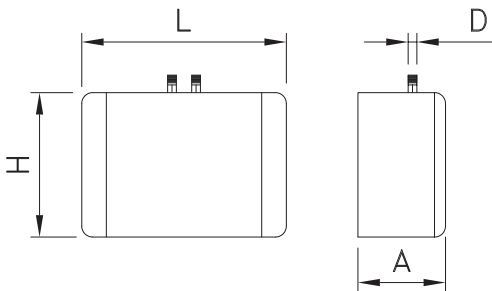

L	A	H	D	°C	W/h	Potencia Power Puissance	Tensión Voltage Tension	Frecuencia Frequency Fréquence	Kg	Barcode	€
187	80	132	3/8"	50°C	2,0	4.400 W	230 V	50 Hz.	1,1	461456	251,00

Enfriador de agua

Water cooler
Refroidisseur d'eau



Características:

Ideal para instalar agua fría en fregaderos, lavamanos, fuentes, etc.

Tecnología para mejorar la higiene.

Termostato para regular la temperatura del agua.

Ahorro de energía gracias a su compresor de 1/6 Hp.

CE

Fabricado en la unión Europea.

Entrada y salida de agua mediante conexión rápida 8 mm.

Enchufe tipo Schuko.

Capaz de enfriar el agua en solo tres minutos.

Envoltorio de acero inoxidable

Entrada y salida de agua Shouko de 1/4"

≤ 4°	14°
↓	↓
88 ltrs/h.	25 ltrs/h.

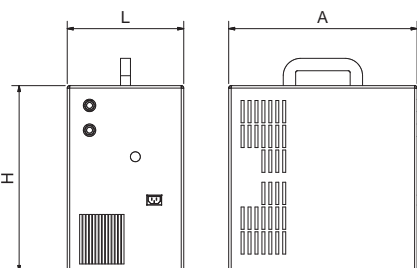
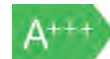

Characteristics:

Ideal for incorporating cool water in sink units, hand washbasins, drinking fountains, etc.

Technology for a better hygiene

Temperature adjustment by thermostat

Energy saving through compressor - 1/6 Hp

CE

Made in UE

Quick inlet and outlet connectors - 8mm.

Schuko plug

Caractéristiques:

Ideal pour installer de l'eau froide sur des éviers, lavemains, fontaines, etc.

Technologie pour améliorer l'hygiène.

Thermostat pour régler la température de l'eau.

Économie d'énergie grâce à son compresseur de 1/6 Hp.

CE

Fabriquée en Union Européenne

Entrée et sortie d'eau grâce à une connexion rapide 8mm

Schuko plug.

Capable de refroidir l'eau en seulement trois minutes

Acier inox















Entrée et sortie d'eau Shouko de 1/4"

L	A	H	Potencia Power Puissance	Tensión Voltage Tension	Frecuencia Frequency Fréquence	Kg	Barcode	€
235	380	375	125 W	220 V	50 Hz.	17,0	461460	679,00

Repuestos fregaderos

Spare parts for sink units

Pièces de rechange pour éviers

	Descripción Description Description	Modelo Model Model	Gr	Barcode	€
	Rebosadero (fregaderos serie 600 y 700 mm) Overflow (sink units models 600 & 700 mm width) Déversoir (éviers 600 et 700 mm de profondeur)	250 mm	420	454220	45,00
		290 mm	450	454222	48,00
		340 mm	525	454224	51,00
		490 mm	600	454225	55,00
	Válvula sin rebosadero Ø 49 mm (fregaderos serie 600 y 700 mm) Drain valve without overflow Ø 49 mm (sink units models 600 & 700 mm) Valvule de drainage sans déversoir Ø 49 mm (éviers model 600 et 700 mm)	1 1/2"	88	454226	7,00
	Reductor desagüe de 2" a 1 1/2" Drain reducer from 2" to 1 1/2" Réducteur pour drainage de 2" à 1 1/2"		150	454218	12,00
	Tapón fregaderos, para válvulas de Ø 49 mm serie 600 y 700 Sink unit plug for valve Ø 49 mm series 600 & 700 Bonde pour valvule Ø 49 mm évier série 600 et 700		20	454604	2,50
	Válvula con rebosadero (fregaderos serie 500 mm, lavamanos, cubetas semiesféricas y fregaderos de gran capacidad) Drain valve with overflow (sink units model 500 mm, washbasins, semispheric bowls, and large capacity single sink units) Valvule de drainage avec déversoir (éviers model 500 mm, lave-mains, semisphériques cuveaux et éviers a grande capacité)	1 1/2"	145	454202	7,50
	Válvula de PVC con rebosadero, acabado cromado Drain valve in PVC with overflow, chrome finished Valvule de drainage avec déversoir en PVC, finition chromé	1 1/2"	150	454205	28,00
	Válvula sin rebosadero (fregaderos serie 500 mm) Drain valve without overflow (sink units model 500 mm) Valvule de drainage sans déversoir (éviers model 500 mm)	1 1/2"	88	454208	6,50
	Válvula de descarga rápida Quick drain valve Valvule pour rapide drainage	2"	3.600	454204	150,00
	Tapón inox cubre-agujeros (diámetro 42 mm) Hole-cover plug in stainless steel (diameter 42 mm) Bonde couvre-trou en acier inox (diamètre 42 mm)		16	454602	4,00
	Sifón de desagüe (fregaderos ancho 500 mm, lavamanos, gran capacidad) U-bended drainpipe (sink units 500 mm depth, washbasins, high capacity) Siphon de drainage (éviers profondeur 500 mm, lave-mains, grand capacité)	1 1/2"	169	454402	6,50
	Sifón de PVC acabado cromado U-bended drainpipe in PVC, chrome finish Siphon en PVC, finition chromé	1 1/2"	170	454408	32,00
	Sifón de latón cromado U-bended drainpipe in chrome brass Siphon en laiton chromé	1 1/2"	1.400	454404	74,00
		2"	2.000	454406	103,00
	Juego de herrajes para puertas de corredera (válido para dos puertas) Sliding doors fixtures set (valid for two doors) Set de ferrures pour portes coulissantes (valide pour deux portes)		85	073850	65,00
	Filtro para enfriador de agua Filter for water cooler Filtre pour refroidisseur d'eau		1.000	464224	74,00

Válvula de desagüe Splus modelo simple
Sink drain - Splus individual model
Bonde Splus modèle simple

Un verdadero sistema de optimización del espacio!!!

Características:

Sistema diseñado para aprovechar mejor el espacio bajo los fregaderos ya que permite desplazar el desagüe hacia la pared.



An effective system for optimizing the space!!!

Characteristics:

A system specially designed for better use of space under sinks, since it allows moving the drain towards the wall.

Un véritable système d'utilisation optimale de l'espace!

Caractéristiques:

Système conçu pour utiliser au mieux l'espace sous l'évier car on peut déplacer la bonde vers le mur.

Modelo Model Model	Gr	48	454209	€
1 1/2				15,00

Un verdadero sistema de optimización del espacio!!!

Características:

Sistema diseñado para aprovechar mejor el espacio bajo los fregaderos ya que permite desplazar el desagüe hacia la pared.

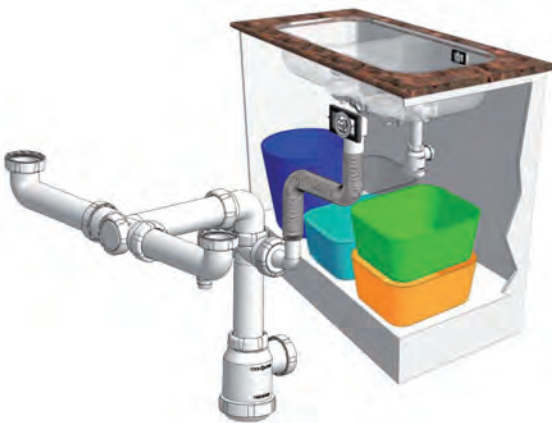

Válvula de desagüe Splus modelo doble
Sink drain - Splus double model
Bonde Splus modèle double

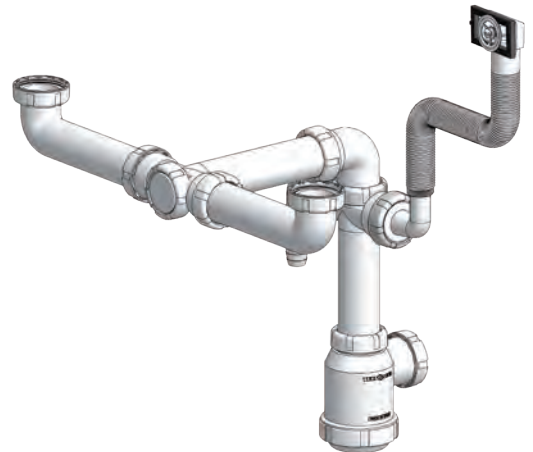

An effective system for optimizing the space!!!

Characteristics:

A system specially designed for better use of space under sinks, since it allows moving the drain towards the wall.

Un véritable système d'utilisation optimale de l'espace!

Caractéristiques:

Système conçu pour utiliser au mieux l'espace sous l'évier car on peut déplacer la bonde vers le mur.

Modelo Model Model	Gr	64	454210	€
1 1/2				20,00

Sumideros sifónicos salida vertical

U-bended drain with vertical outlet
Bouches avec siphon de sortie verticale



Caractéristiques:
Fabriquée entièrement en acier inoxydable.
Rainure annulaire de 6.5 mm.

Características:
Fabricado totalmente en acero inoxidable.
Ranura anular de 6,5 mm.

Characteristics:
Wholly made of stainless steel.
Annular slot of 6.5 mm.

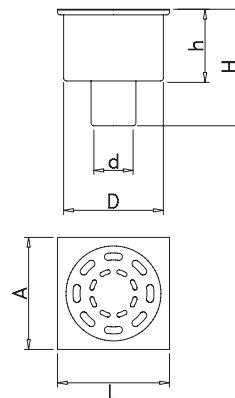

L	A	H	h	D	d	Kg	Barcode	€
100	100	72	47	80	40	0,3	454228	75,00
150	150	99	59	110	48	1,1	454238	115,00
250	250	195	115	200	100	4,4	454230	310,00

Sumidero extra-bajo

Extra floor grid with grating
Bouche d'égout extra bas

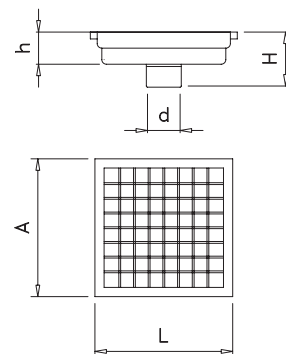

L	A	H	h	d	Kg	Barcode	€
300	300	118	75	75	4,8	454242	350,00

Sumidero sifónico salida horizontal

U-bended drain with horizontal outlet
Bouche avec siphon de sortie horizontale



Características:
Fabricado totalmente en acero inoxidable.
Ranura anular de 6,5 mm.

Characteristics:
Wholly made of stainless steel.
Annular slot of 6.5 mm.

Caractéristiques:
Fabriquée entièrement en acier inoxydable.
Rainure annulaire de 6.5 mm.

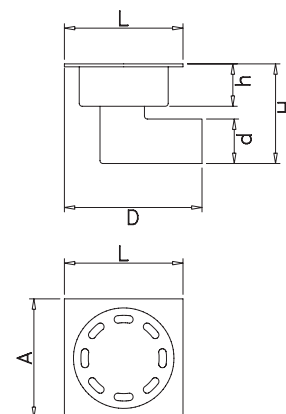

L	A	H	h	D	d	Kg	Barcode	€
100	100	95	55	122	40	1	454232	89,00

Sumidero sanitario salida vertical

Sanitary floor-drainer vertical outlet
Égout sanitaire sortie verticale



Novedad
New
ouveau

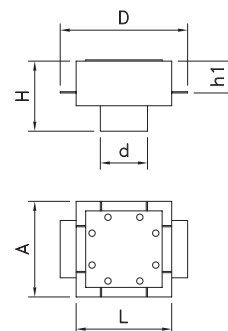

L	A	H	h	h1	D	d	Kg	Barcode	€
150	150	110	70	50	200	75	2,2	454244	180,00

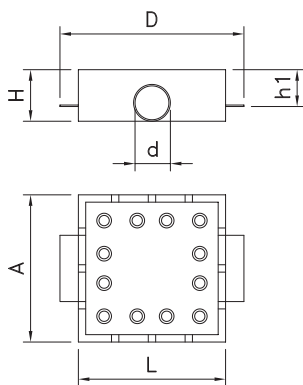

Sumidero sanitario salida horizontal

Sanitary floor-drainer horizontal outlet
Égout sanitaire sortie horizontale

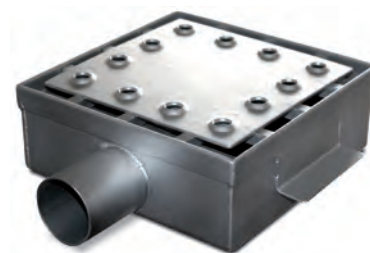

Novedad
ew
ouveau

L	A	H	h1	D	d	Kg	Barcode	€
200	200	75	50	250	50	3,72	454246	225,00

Sumidero industrial sifónico salida horizontal

U-bended floor grid with grating
Bouches avec siphon de sortie horizontale

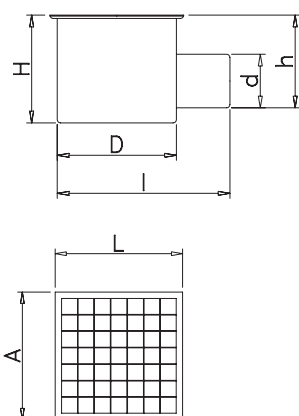

Características:
Fabricado totalmente en acero inoxidable.
Cestillo de recogida de sólidos.
Sifón extraíble.

Caractéristiques:
Fabriquée entièrement en acier inoxydable.
Dépôt pour ramassage de solides.
Siphon amovible.

Characteristics:
Wholly made of stainless steel.
Dump for solid deposits.
Removable U-bended sump.



	L	A	H	h	D	l	d	Kg	Barcode	€
	150	150	120-150	115	130	200	75	2,2	454234	169,00
	250	250	170	180	155	245	110	4,6	454236	460,00

Canal colector

Drainer channel trap
Canal égout

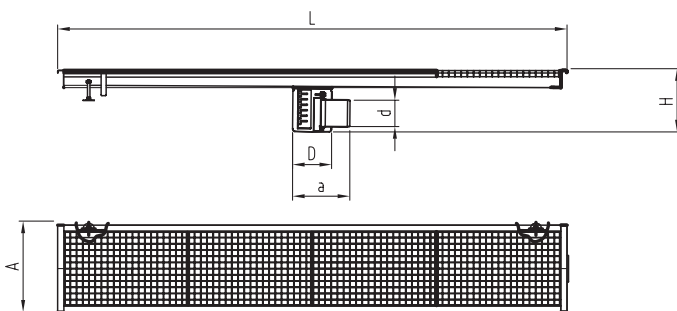
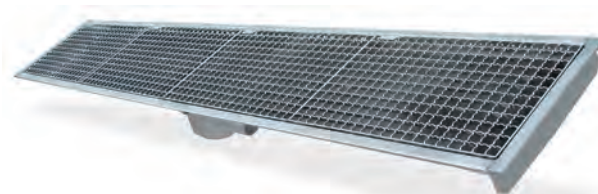

Características:
Fabricado totalmente en acero inoxidable.
Cestillo de recogida de sólidos.
Sifón extraíble.

Characteristics:
Wholly made of stainless steel.
Dump for solid deposits.
Detachable U-bended sump.

Caractéristiques:
Fabriquée entièrement en acier inoxydable.
Dépôt pour ramassage de solides.
Siphon amovible.

L	A	H	a	D	d	Kg	Barcode	€
1.000	300	245	230	157	110	15,0	454250	600,00
2.500	300	245	230	157	110	32,0	454252	990,00

Sistema modular de canal ranurado





Slot channel, modular concept
Système modulaire de canal avec rainures

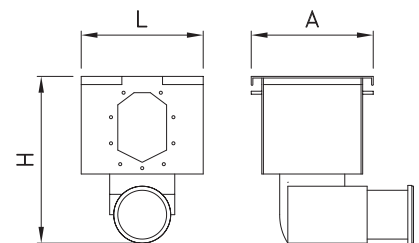

Sumidero canal modular ranurado

Sump unit for slot channel
Égout canal modulaire avec rainures





	L	A	H	 2,5/4	 Kg		€
	200	200	300	2,5	3,10	454248	228,00
	200	200	360	1,4	3,82	454249	324,00

Tramos rectos para canal modular ranurado

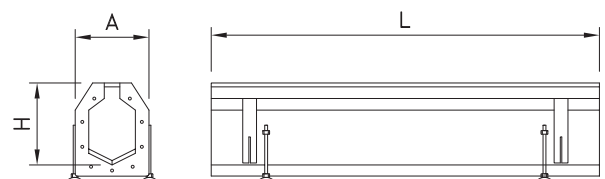
Straight section for modular slot channel
Sections droites pour canal modulaire avec rainures



L	A	H	 Kg		€
500	95	100	2,20	454254	221,00
1.000	95	100	3,90	454256	259,00

Tramo en esquina para canal modular ranurado

Corner section for modular slot channel
Section en angle pour canal modulaire avec rainures

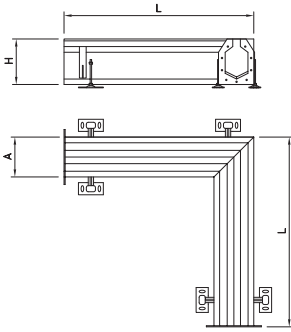

L	A	H	Kg	Barcode	€
500	105	90	4,20	454253	488,00



Tramo en T para canal modular ranurado

T shaped section for modular slot channel
Section en T pour canal modulaire avec rainures

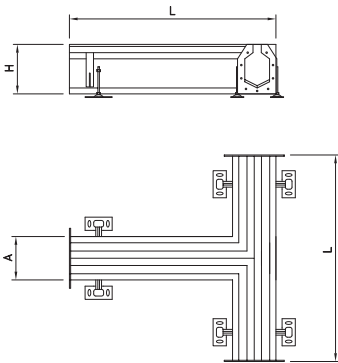

L	A	H	Kg	Barcode	€
500	500	100	3,90	454257	543,00



Tapa para canal modular ranurado

Trap for modular slot channel
Couvercle pour canal modulaire avec rainures

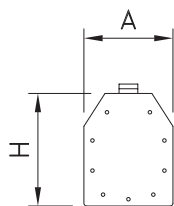

A	H	Kg	Barcode	€
95	100	0,20	454258	38,00



Adaptador para canal modular ranurado

Adapter for modular slot channel
Adaptateur pour canal modulaire avec rainures

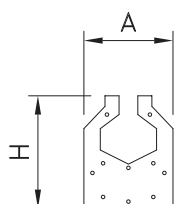

A	H	Kg	Barcode	€
95	100	0,22	454259	58,00



Separador de grasas

Grease trap
Piège de graisse



Características:

Fabricado en polietileno de alta densidad.
Rendimiento de 0 a 30 comidas.
Sus reducidas dimensiones lo hacen perfecto para su montaje en el interior del mobiliario.
Válido para montaje en exteriores.

Characteristics:

Made of high-density polyethylene.
Efficiency from 0 to 30 meals.
Specially for being incorporated to the units of furniture as a built-in part due to its reduced dimensions.
Valid for external use.

Caractéristiques:

Fabriqué en polyéthylène haute densité.
Capacité de 0 à 30 repas.
Idéal pour être incorporé aux unités de mobilier comme une partie intégrée en raison de ses dimensions réduites.
Valable pour un usage externe.

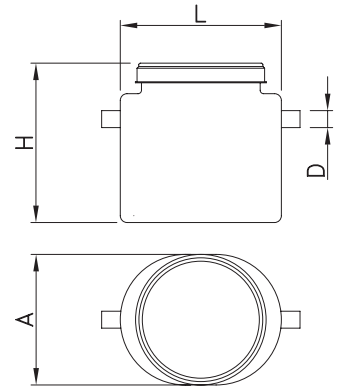

L	A	H	D	Kg	Barcode	€
470	385	500	50	9,75	455002	675,00

Separador de grasas inox

Stainless steel Grease trap
Piège de graisse acier inoxydable



Características:

Diseñado para restaurantes, hoteles, fastfood, etc..
Fácil instalación y mantenimiento.
Rendimiento de 0 a 50 comidas.
Incluye:
Latiguillo flexible de evacuación.
Cestillo.
Desagües flexibles para la entrada y salida de agua.

Characteristics:

Applicable for restaurant, hotels, fast food, etc.
Easy installation and maintenance.
Capacity from 0 to 50 meals.
Includes:
Evacuation flexible hose.
Basket.
Flexible drains for water inlet and outlet.

Caractéristiques:

Approprié aux restaurants, hôtels, fastfood, etc.
Installation et entretien faciles.
Capacité de 0 à 50 repas.
Comprend:
Evacuation flexible.
Résevier.
Flexible drains pour entrée et sortie d'eau.

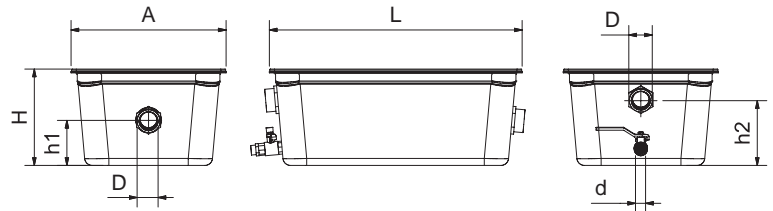

L	A	H	D	d	h1	h2	lit	Kg	Barcode	€
530	325	200	1" 1/2	1/2"	97	136	20	4,80	057202	359,00

Separador de grasas inox

Stainless grease trap
Piège de graisse inox

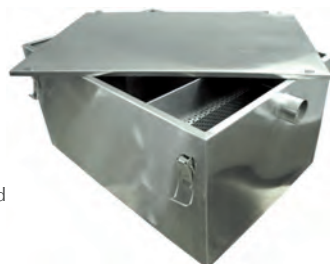

Characteristics:

Wholly made of stainless steel.
Capacity from 0 to 75 meals.
Volume: 1l/sc.
Included: Stainless steel airtight lid, basket and detachable outlet DN50.

Caractéristiques:

Fabriqué entièrement en acier inoxydable.
Capacité de 0 à 75 repas.
Débit : 1l/sc.
Inclus : Couvercle étanche, panier et sortie amovible DN50.

Características:

Fabricado totalmente en acero inoxidable.
Rendimiento de 0 a 75 comidas.
Caudal: 1l/sg.
Incluye: Tapa estanca de acero inoxidable, cestillo registrable y salida desmontable DN50.

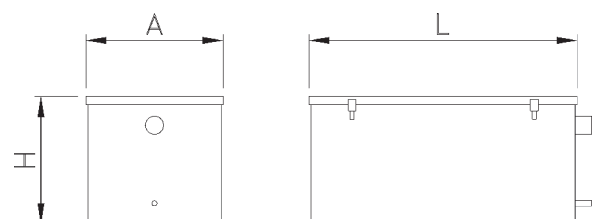

L	A	H	lit	Kg	Barcode	€
565	340	290	50	20,0	455004	950,00

GRIFERIA

Taps and fittings
Robinetterie

NOVEDADES

News
Nouveautés

Grifo ducha sobremesa doble entrada, dos aguas monomando codo High neck double inlet one handle shower fitting, elbow operation Robinet douchette double entrée deux eaux mélangeur à coude	237
Grifo ducha sobremesa, dos mandos 1/4 vuelta Deck mounted double inlet shower fitting, 1/4 turn Robinet douchette deux entrées, deux poignées 1/4 de tour	238
Grifo ducha sobremesa monomando dos aguas, extrabajo Extra low double inlet shower fitting Robinet douchette mélangeur deux eaux, extra-bas	241
Grifo ducha sobremesa monomando dos aguas extrabajo con caño Extra low double inlet shower fitting with spout Robinet douchette mélangeur deux eaux extra-bas avec col de cygne	241
Grifo cocina monomando sobremesa cuello de cisne de acero inoxidable Stainless steel one-handle gooseneck table tap Robinet mélangeur sur table avec col de cygne en acier inoxydable	245
Grifo monomando sobremesa caño alto para fregadero Sink with single lever, high spout Mélangeur évier col de cygne haut	246
Grifo columna sobremesa 2 aguas pomo aislante Double inlet column tap with insulated head Robinet colonne 2 eaux poignée isolante	253
Monomando lavabo One handle mixer for basin Mélangeur lavabo	266
Monomando bidé One handle mixer for bidet Mélangeur bidet	266
Monomando ducha One handle mixer for shower Mélangeur douche	267
Monomando baño/ducha One-handle mixer for bath/shower Mélangeur baignoire	267

Grifo ducha sobremesa básico

Basic shower tap
Robinet douche basique

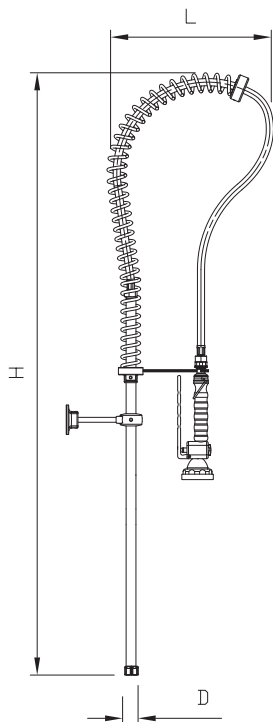

Disponible mástil extra-corto.
Extra-short table fitting support available.
Tuyau extra court sur table.

462801 € 39,00

269 H 700 mm.

Op Opcional / Optional / Optionnel

L	H	D	litros/h	°C max	Kg	Barcode	€
450	1.200	1/2"	17	80 °C	4,15	463068	159,00

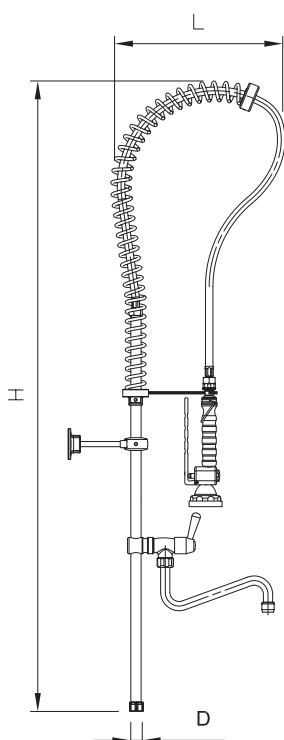

L	H	D	litros/h	°C max	Kg	Barcode	€
450	1.200	1/2"	17	80 °C	4,95	463070	221,00

Grifo ducha sobremesa de un agua

Single inlet table shower fitting
Robinet douche sur table à une eau

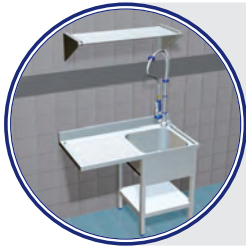

Disponibile mástil extra-corto.
Extra-short table fitting support available.
Tuyau extra court sur table.

462801 € 39,00

269 H 700 mm.

Op Opcional / Optional / Optionnel

L	H	D	U/W/A	°C	°F	Kg	Barcode	€
450	1.300	1/2"	17	80 °C	176 °F	4,4	463054	186,00

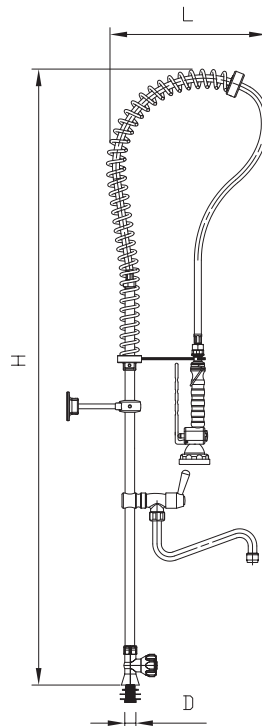
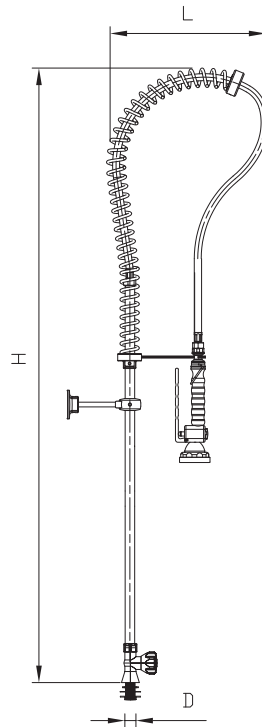

L	H	D	U/W/A	°C	°F	Kg	Barcode	€
450	1.300	1/2"	17	80 °C	176 °F	5,20	463058	248,00

Grifo ducha sobremesa de dos aguas

Double inlet table shower fitting
Robinet douche sur table à deux eaux

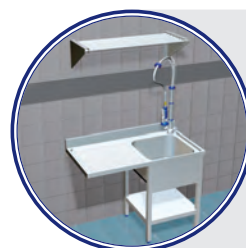
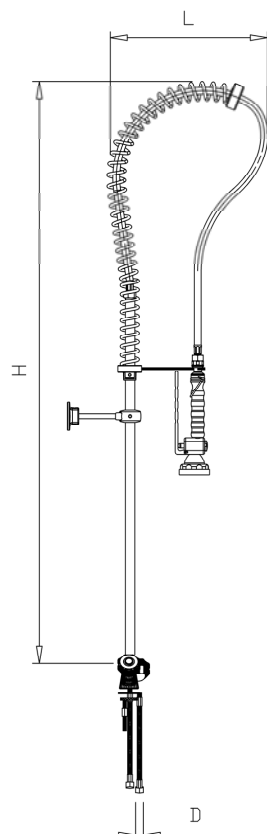

Disponibile mástil extra-corto.
Extra-short table fitting support available.
Tuyau extra court sur table.

462801 € 39,00

269 H 700 mm.

Op Opcional / Optional / Optionnel

L	H	D	litros/lit	°C max	Kg	Barcode	€
450	1.300	1/2"	17	80 °C	4,42	463056	197,00

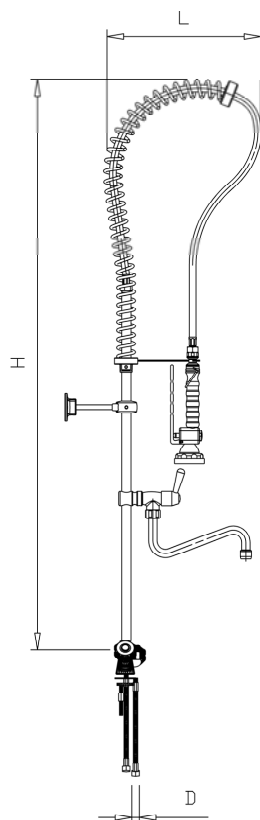

L	H	D	litros/lit	°C max	Kg	Barcode	€
450	1.300	1/2"	17	80 °C	5,26	463060	258,00

Grifo ducha mural dos aguas monomando

Double inlet shower fitting wall mounted

Robinet douche mural deux eaux



Disponibile mástil extra-corto.
Extra-short table fitting support available.
Tuyau extra court sur table.

462801 € 39,00

269 H 700 mm.

Op Opcional / Optional / Optionnel

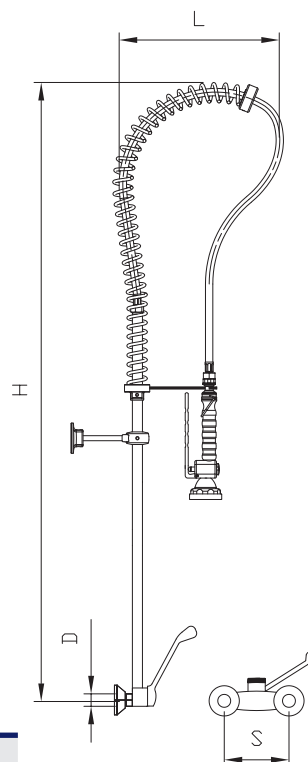

L	H	D	S	litros/lit	°C max	Kg	Barcode	€
450	1.250	1/2"	150	17	80 °C	4,60	463064	295,00

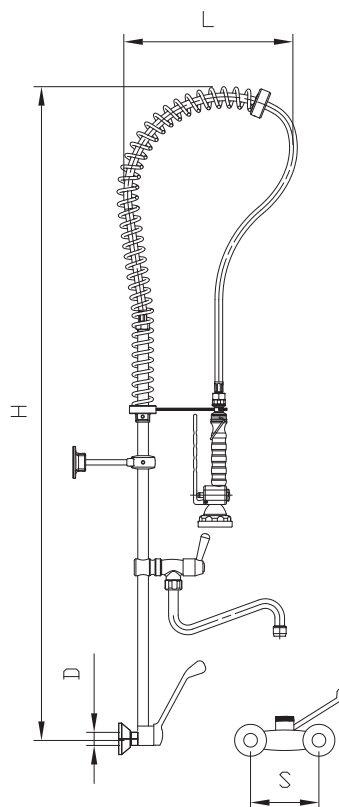

L	H	D	S	litros/lit	°C max	Kg	Barcode	€
450	1.250	1/2"	150	17	80 °C	5,40	463066	366,00

Grifo ducha mural dos aguas 1/4 de vuelta con levas

Double inlet 1/4 turn wall-mounted shower fitting

Robinet douchette mural deux eaux 1/4 tour

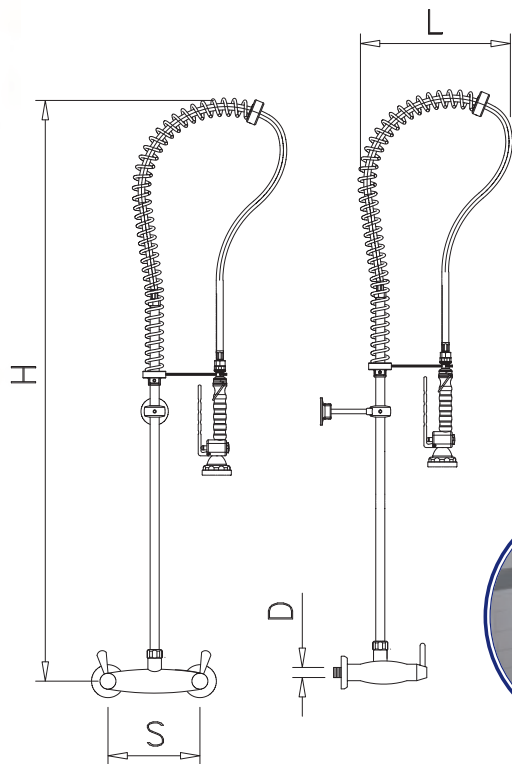

Disponible mástil extra-corto.
Extra-short table fitting support available.
Tuyau extra court sur table.

462801 € 39,00

269 H 700 mm.

Op Opcional / Optional / Optionnel

L	H	D	S	u/m/4	Kg	Barcode	€
450	1.250	1/2"	150	17	5,70	463042	218,00

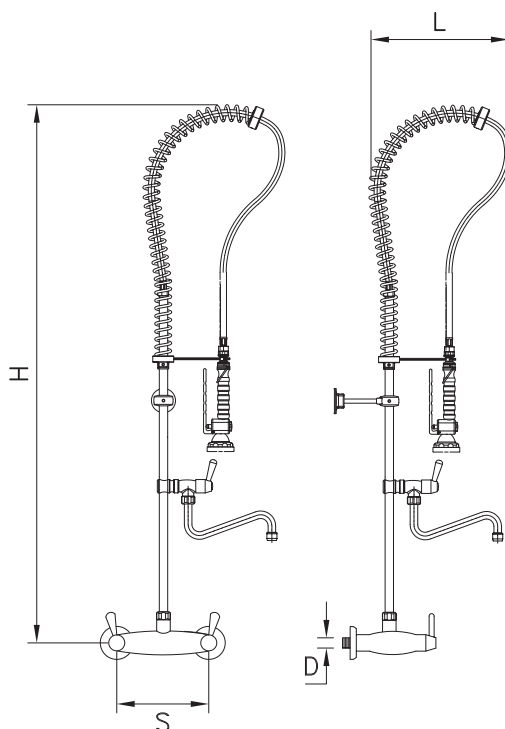

L	H	D	S	u/m/4	Kg	Barcode	€
450	1.335	1/2"	150	17	6,80	463044	290,00

Grifo ducha sobremesa dos aguas monomando codo
 Double inlet one handle table shower fitting elbow operation
 Robinet douche sur table à deux eaux levier à coude



Disponibile mástil extra-corto.
 Extra-short table fitting support available.
 Tuyau extra court sur table.

462801 € 39,00

269 H 700 mm.

Opcional / Optional / Optionnel

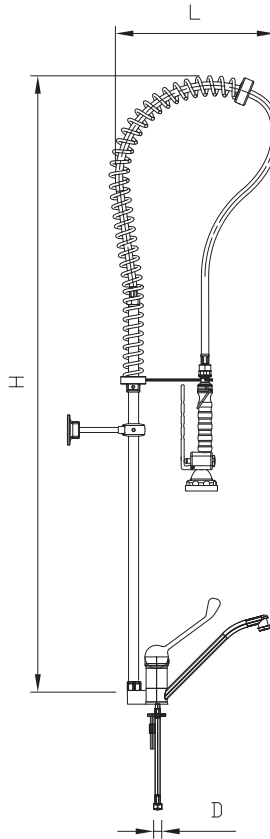

L	H	D	l/min	°C max.	Kg		€
450	1.250	3/8"	17	80 °C	5,90	463062	323,00

Grifo ducha sobremesa doble entrada, dos aguas monomando codo
 High neck double inlet one handle shower fitting, elbow operation
 Robinet douchette double entrée deux eaux mélangeur à coude



Disponibile mástil extra-corto.
 Extra-short table fitting support available.
 Tuyau extra court sur table.

462801 € 39,00

269 H 700 mm.

Opcional / Optional / Optionnel

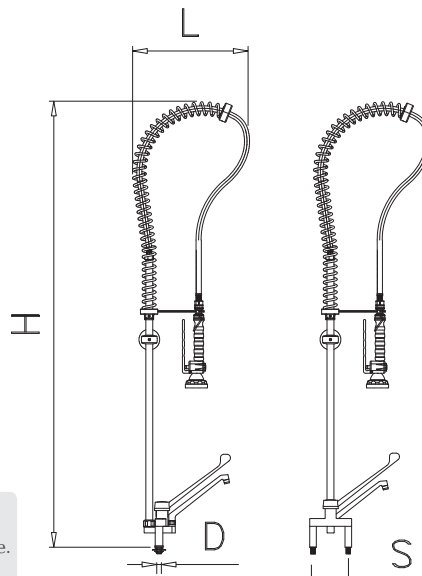

L	H	D	S	l/min	°C max.	Kg		€
450	1.200	1/2"	155	17	80 °C	5,90	463094	485,00



Grifo ducha sobremesa, dos mandos 1/4 vuelta

Deck mounted double inlet shower fitting, 1/4 turn

Robinet douchette deux entrées, deux poignées 1/4 de tour



Novedad
ew
nouveau

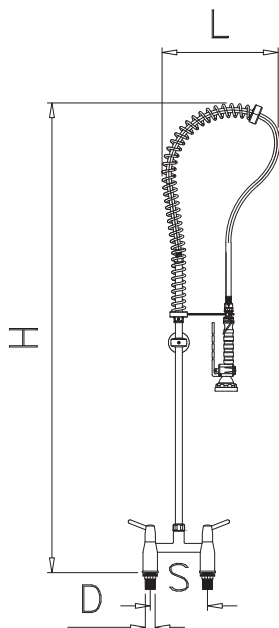

Disponible mástil extra-corto.
Extra-short table fitting support available.
Tuyau extra court sur table.

462801 € 39,00

269 H 700 mm.

Op Opcional / Optional / Optionnel

L	H	D	S	litros/lit	°C max	Kg	Barcode	€
450	1.200	1/2"	155	17	80 °C	5,70	463090	287,00



Novedad
ew
nouveau

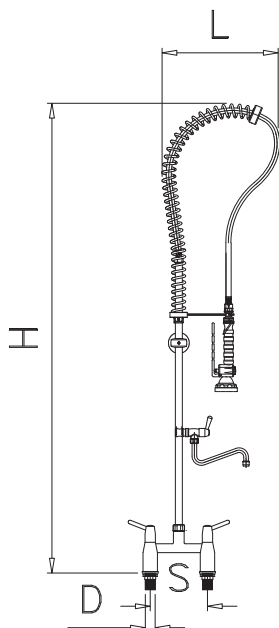

L	H	D	S	litros/lit	°C max	Kg	Barcode	€
450	1.200	1/2"	155	17	80 °C	6,80	463092	352,00

Grifo ducha sobremesa dos aguas 1/4 de vuelta

Double inlet table 1/4 turn shower fitting
Robinet douche sur table à deux eaux 1/4 de tour

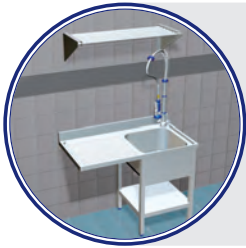

Disponibile mástil extra-corto.
Extra-short table fitting support available.
Tuyau extra court sur table.

462801 € 39,00

269 H 1.300

Op Opcional / Optional / Optionnel

L	H	D	U/W/A	°C max	Kg	Barcode	€
450	1.300	1/2"	17	80 °C	4,50	463046	222,00

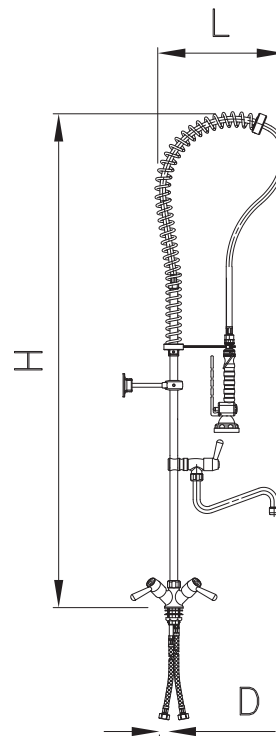
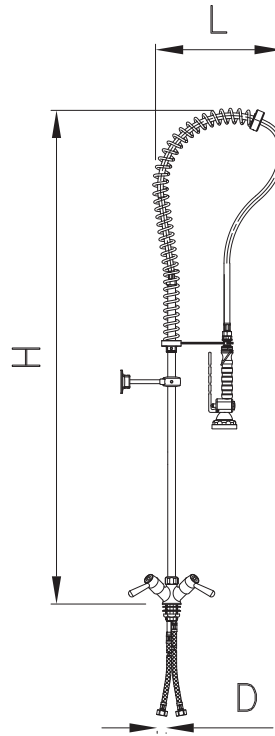

L	H	D	U/W/A	°C max	Kg	Barcode	€
450	1.300	1/2"	17	80 °C	5,60	463048	290,00

Grifo ducha sobremesa dos aguas monomando

Double inlet one handle table inox shower fitting elbow operation
Robinet docuhe sur table à deux eaux en acier inoxydable

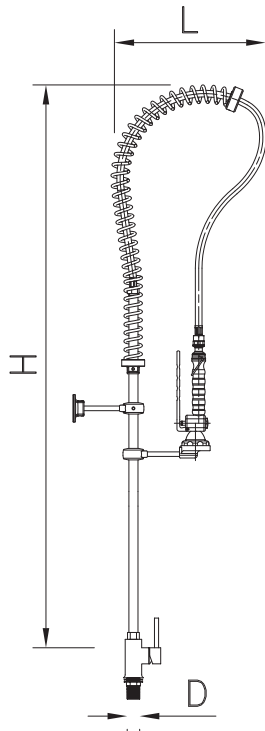

Características:

Todas las partes metálicas están construidas en acero inoxidable.

Characteristics:

Wholly made of stainless steel and plastic.

Caractéristiques:

Totalement en acier inoxydable et en plastique.

L	H	D	U/L/A	°C	Kg	Barcode	€
450	1.300	1/2"	17	80 °C	5,00	463072	820,00

Grifo ducha sobremesa dos aguas monomando leva

Double inlet one handle table shower fitting elbow operation
Robinet douche sur table à deux eaux levier à coude

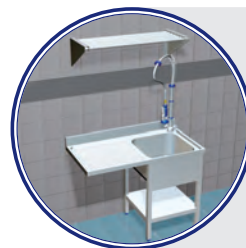
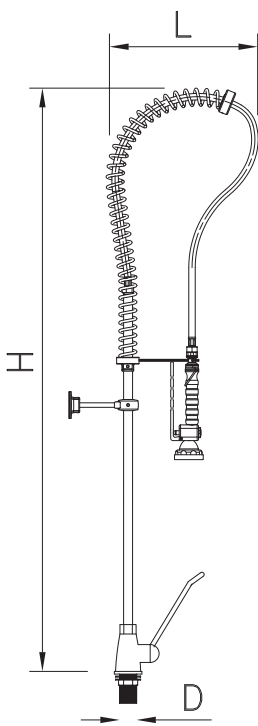

Disponibile mástil extra-corto.
Extra-short table fitting support available.
Tuyau extra court sur table.

462801 € 39,00

269 H 700 mm.

Opcional / Optional / Optionnel

L	H	D	U/L/A	°C	Kg	Barcode	€
450	1.300	3/8"	17	80 °C	4,80	463074	275,00

Grifo ducha sobremesa dos aguas monomando con caño

Double inlet one handle table shower fitting with spout
Robinet douche sur table à deux eaux avec jet



Tirante a pared para grifo ducha.
Wall rod for shower fitting.
Tringle au mur pour robinet douche.

Incluido / Included / Inclus

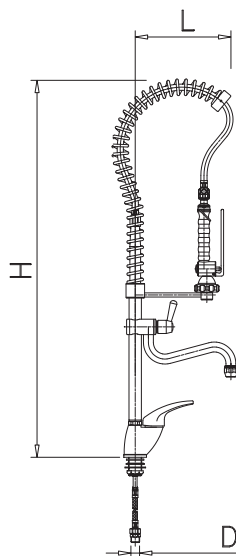

L	H	D	Litros/min	°C max.	Kg		€
230	900	3/8"	18	80 °C	5,80	463052	390,00

Grifo ducha sobremesa monomando dos aguas, extrabajo

Extra low double inlet shower fitting
Robinet douchette mélangeur deux eaux, extra-bas

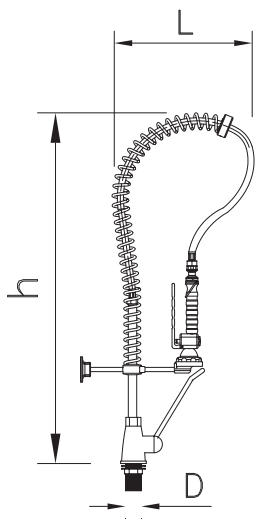

Novedad
Nouvel
Niveau

L	h	D	Litros/min	°C max.	Kg		€
450	600	1/2"	17	80 °C	3,70	463038	349,00

Grifo ducha sobremesa monomando dos aguas extrabajo con caño

Extra low double inlet shower fitting with spout
Robinet douchette mélangeur deux eaux extra-bas avec jet

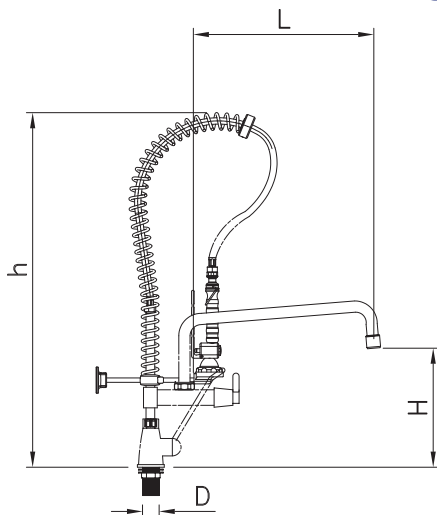

Novedad
Nouvel
Niveau

L	H	h	D	Litros/min	°C max.	Kg		€
450	300	600	1/2"	17	80 °C	4,20	463040	385,00

Grifo ducha sobremesa básico dos aguas extra bajo

Low profile double inlet shower fitting
Robinet douche à deux eaux avec profil bas

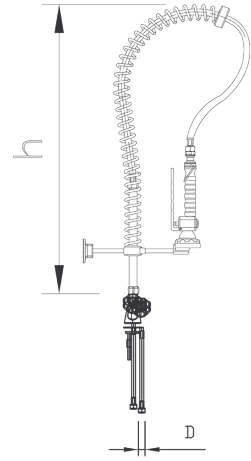

h	D	litros/min	°C xEU	Kg	Barcode	€
600	1/2"	17	80 °C	3,50	463080	275 ,00

Grifo ducha sobremesa básico dos aguas extra bajo con caño

Extra low double inlet basic shower fitting with spout
Robinet douche à deux eaux avec jet, modèle extra-bas

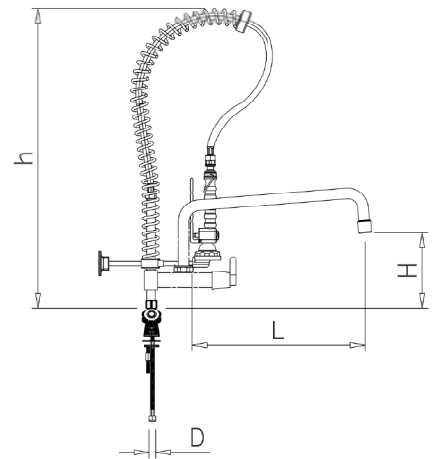

L	H	h	D	litros/min	°C max	Kg	Barcode	€
300	240	600	1/2"	17	80 °C	4,00	463081	315 ,00

Grifo ducha sobremesa serie doméstico con piña

Domestic shower fitting with head
Robinet douche modèle domestic avec pomme de douche

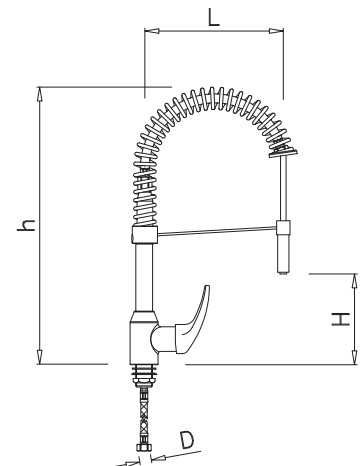

L	H	h	D	litros/min	°C xEU	Kg	Barcode	€
230	150	500	1/2"	17	80 °C	3,50	463051	284 ,00

Grifo ducha sobremesa dos aguas modelo accionamiento extensible

Double inlet Shower tap lift up model
Robinet douche à deux eaux, modèle retractable

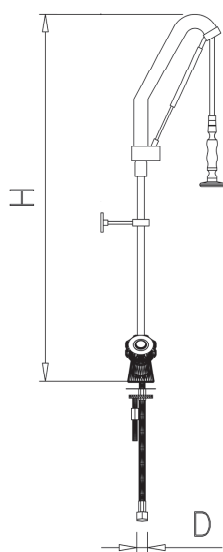

h	D	l/min	°C max.	Kg		€
1.050	1/2"	17	80 °C	4,00	463076	432,00

Grifo ducha sobremesa dos aguas modelo accionamiento extensible con caño

Double inlet shower tap with spout, lift-up model
Robinet douche à deux eaux avec jet, modèle retractable

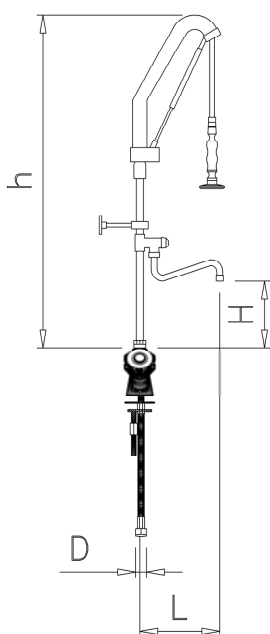

L	H	h	D	l/min	°C max.	Kg		€
250	225	1.050	1/2"	17	80 °C	5,00	463078	503,00

Expositor central de grifería

Centre taps and shower display
Exposant de robinetterie centrales



Se pueden exponer 8 grifos por nivel.
8 taps on each level.
8 robinets par niveau.

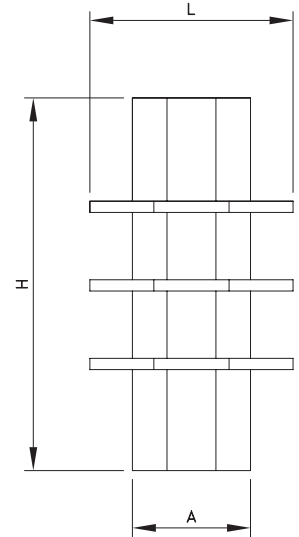

El precio no incluye la grifería.
Taps not included in the price.
Le prix n'inclut pas la robinetterie.

L	A	H	Kg	Barcode	€
1.690	530	2.300	44	064402	790,00

Expositor mural de grifería

Wall mounted taps and shower display
Exposant de robinetterie mural



Se pueden exponer 5 grifos por nivel.
5 taps on each level.
5 robinets par niveau.



El precio no incluye la grifería.
Taps not included in the price.
Le prix n'inclut pas la robinetterie.



L	A	H	Kg	Barcode	€
1.250	300	245	4	064404	200,00

Grifo sobremesa de un agua serie 1/4 de vuelta

Single inlet 1/4 turn model table tap
Robinet à une eau sur table modèle 1/4 de tour

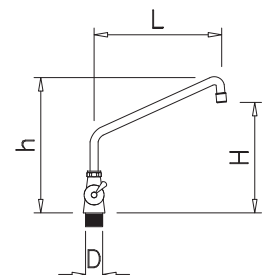

L	H	h	D	Water/Water	Kg	Barcode	€
250	240	300	1/2"	16	1,00	463426	98,00

Grifo cocina monomando sobremesa de acero inoxidable

Kitchen tap
Robinet de cuisine

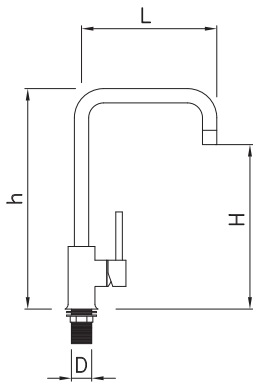



Características:
Apto para exterior.
Acero inox.

Characteristics:
Suitable for outdoor.
Stainless steel.
One-piece mixer cartridge with ceramic discs.

Caractéristiques:
Approprié pour l'extérieur.
En acier inoxydable.



L	H	h	D	 1/2"/3/4"	 Kg		€
215	300	450	3/8"	9,5	2,00	465206	207,00

Grifo cocina monomando sobremesa alto de acero inoxidable

Stainless steel one-handle table tap high model
Robinet monocommande sur table en acier inoxydable modèle haut

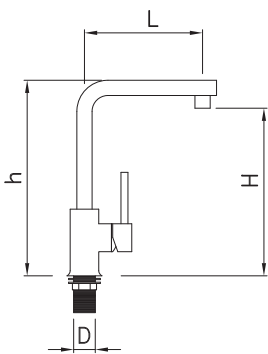



Características:
Apto para exterior.
Acero inox.

Characteristics:
Suitable for outdoor.
Stainless steel.
One-piece mixer cartridge with ceramic discs.

Caractéristiques:
Approprié pour l'extérieur.
En acier inoxydable.



L	H	h	D	 1/2"/3/4"	 Kg		€
220	260	308	3/8"	9,5	2,00	465208	207,00

Grifo cocina monomando sobremesa cuello de cisne de acero inoxidable

Stainless steel one-handle gooseneck table tap
Robinet mélangeur sur table avec col de cygne en acier inoxydable

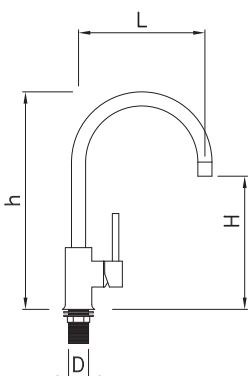

Características:
Apto para exterior.
Acero inox.

Characteristics:
Suitable for outdoor.
Stainless steel.
One-piece mixer cartridge with ceramic discs.

Caractéristiques:
Approprié pour l'extérieur.
En acier inoxydable.



 **Novedad**
New
Nouveau

L	H	h	D	 1/2"/3/4"	 Kg		€
245,6	260	309	3/8"	9,5	3,00	465210	384,00

Grifo monomando sobremesa caño alto para fregadero

Sink with single lever, high spout
Mélangeur évier col de cygne haut



Novedad
ew
ouveau

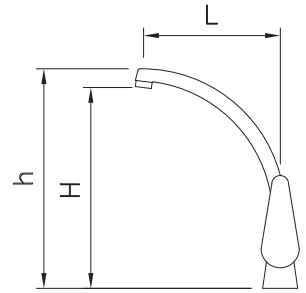

L	H	h	D	litros/l	Gr	Barcode	€
178,5	262	288	1/2"	16	0,89	464624	54,00

Grifo ducha monomando sobremesa dos aguas serie doméstico

Domestic model double inlet one handle table shower fitting
Robinet douche sur table à deux eaux modèle domestic

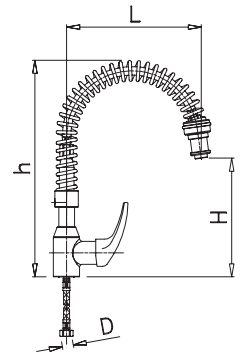

L	h	D	H	litros/l	°C	Kg	Barcode	€
230	415	1/2"	235	18	80 °C	4	463050	207,00

Grifo monomando sobremesa extensible de codo

One handle elbow functioning tap, extending shower
Robinet monocommande à coude, douche extensible



Longitud de manguera: 1,2 mts.
Hose length: 1,2 mts.
Longueur du tuyau: 1,2 mts.

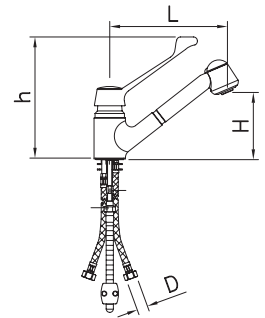

L	H	h	D	litros/l	Kg	Barcode	€
228	130	240	1/2"	18	3	463206	155,00

Grifo monomando sobremesa extensible de codo leva larga

Double inlet one handle tap elbow functioning, extending shower
Robinet mitigeur douchette extractible pomme longue



Longitud de manguera: 1,2 mts.
Hose length: 1,2 mts.
Longueur du tuyau: 1,2 mts.

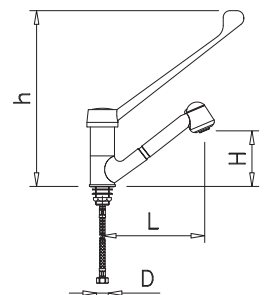

L	H	h	D	litros/l	Kg	Barcode	€
192	116	300	1/2"	13	1,40	463236	103,00

Grifo monomando sobremesa de codo dos aguas

Double inlet one handle tap elbow functioning
Robinet monocommande à coude pour deux eaux

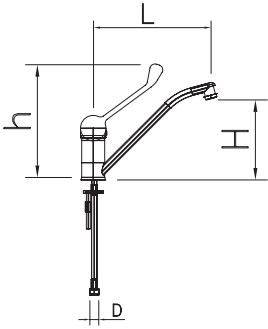

L	H	h	D	litros/di	Kg	Barcode	€
240	120	260	3/8"	17	1,16	463204	60,00



Grifo monomando sobremesa de codo dos aguas serie monoblock

Monoblock model double inlet one handle tap elbow functioning
Robinet monocommande à coude pour deux eaux modèle monoblock

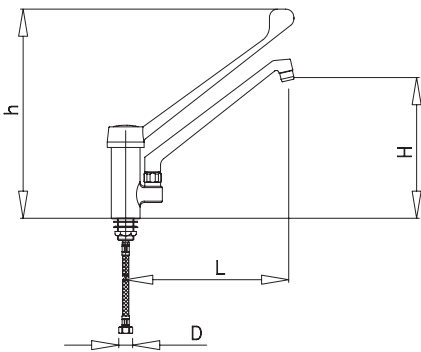

L	H	h	D	litros/di	Kg	Barcode	€
250	190	380	1/2"	22	2,46	463214	135,00



Grifo monomando sobremesa giratorio dos aguas

Double inlet rotating mixer tap
Robinet monocommande giratoire deux eaux

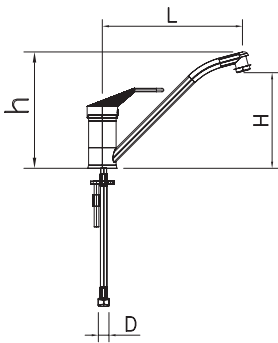

L	H	h	D	litros/di	Kg	Barcode	€
250	120	140	3/8"	17	1,19	463602	50,00



Grifo monomando sobremesa caño giratorio elevado

Single lever table tap with elevated rotating spout
Robinet monocommande sur table avec jet giratoire élevé

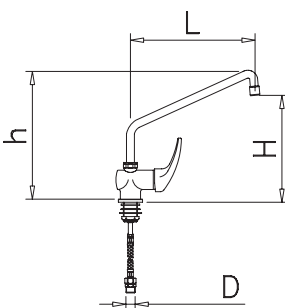

L	H	h	D	litros/di	Kg	Barcode	€
300	250	315	3/8"	17	2,06	463226	135,00



Grifo monomando sobremesa de codo dos aguas serie monoblock-elevado

Monoblock-elevated model double inlet one handle tap elbow functioning
 Robinet monocommande à coude pour deux eaux modèle monoblock-haut

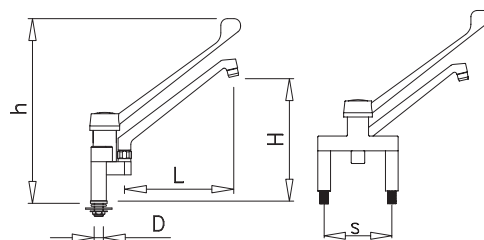

L	H	h	D	S	 UNW/A1	 Kg		€
260	210	520	1/2"	155	22	3,83	463216	205,00

Grifos giratorios sobremesa dos aguas

Double inlet rotating tap
 Robinet giratoire deux eaux

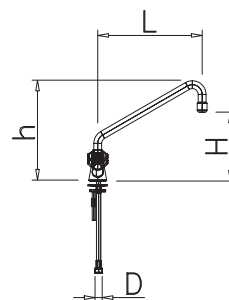



L	H	h	D	 UNW/A1	 Kg		€
200	185	240	1/2"	21	1,45	463402	65,00
250	190	260	1/2"	21	1,43	463404	67,00
300	250	300	1/2"	21	1,51	463406	69,00

Grifo giratorio sobremesa dos aguas serie 1/4 de vuelta

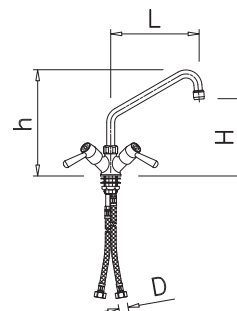
1/4 turn model double inlet rotating tap
 Robinet giratoire deux eaux modèle 1/4 de tour



L	H	h	D	 UNW/A1	 Kg		€
250	200	260	1/2"	21	1,25	463420	92,00

Grifo mezclador sobremesa con mandos 1/4 de vuelta

Quarter turn lever mixer tap
Robinet mitigeur modèle 1/4 de tour

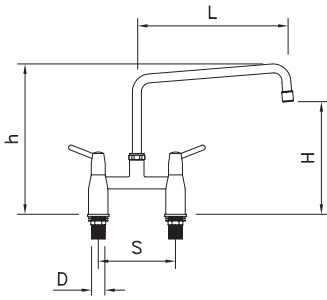

L	H	h	D	S	W	Kg	Barcode	€
250	240	300	1/2"	155	17	1,85	463430	157,00



Grifo monomando sobremesa de codo elevado

Elevated straight spout one-handle tap
Robinet monocommande à jet haut

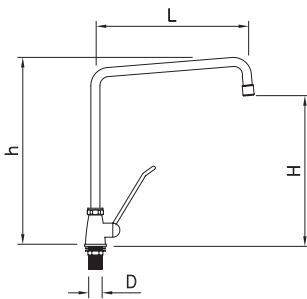

L	H	h	D	W	Kg	Barcode	€
300	295	355	3/8"	18	1,65	463227	143,00



Grifo cocina sobremesa doble función de acero inoxidable

Stainless steel double purpose one handle tap
Robinet monocommande à double usage en acier inoxydable

Características:

Apto para exterior.
Acero inox.
Cartucho sellado mezclador con discos ceramicos de ø35 mm.
Suministrado con latiguillos flexibles de 3/8" y longitud 370 mm.

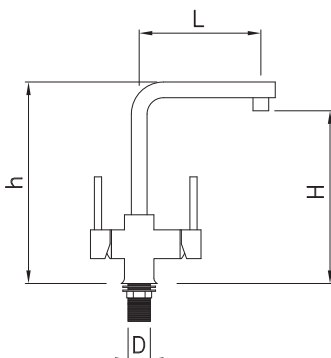

L	H	h	D	W	Kg	Barcode	€
187	275	360	3/8"	9,5	2,00	463222	207,00



Conducto de agua independiente
Separated pipe filter water
Conduite d'eau spéciale

Leva agua independiente (izquierda)
Filter lever (left side)
Manette eau speciale (a gauche)

Leva monomando mezclada (derecha)
Mixer level (right side)
Manette monocommande melanger (a droite)

3 entradas de agua con 2 salidas independientes nos permitirán diferentes utilidades.
3 water inputs and 2 independent outputs permit us different utilities.
3 entrées d'eau et 2 sorties independantes nous permettront diverses utilités.



Characteristics:

Stainless steel
One-piece mixer cartridge with ceramic discs.
Cartridge diameter 35 mm
3/8" Stainless steel flexible connections included and 370 mm long.

Caractéristiques:

Approprié pour l'extérieur.
En acier inoxydable.
Cartouche scellée mélangeur à disques céramiques ø35 mm.
Livré avec des tuyaux flexibles de 3/8" et de longueur 370 mm.

Grifo giratorio sobremesa un agua 1/4 de vuelta caño alto

Single inlet 1/4 turn rotating tap, elevated model
 Robinet tournant 1/4 tour une eau bec de robinet haut

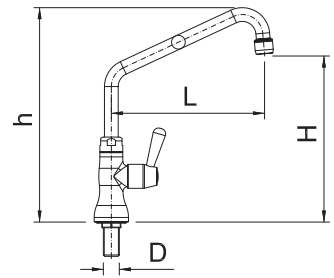

L	H	h	D	litros/min	Kg	Barcode	€
250	240	280	1/2"	22	1,10	463434	86,00

Grifo giratorio sobremesa dos aguas 1/4 de vuelta caño bajo

1/4 turn double inlet rotating tap with low profile spout
 Robinet giratoire bas 1/4 de tour à deux eaux

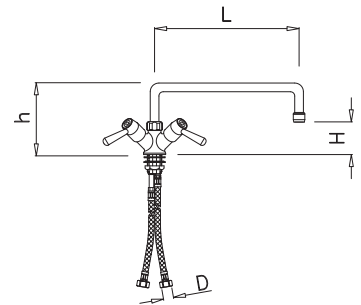

L	H	h	D	litros/min	Kg	Barcode	€
300	70	145	1/2"	21	1,50	463422	88,00

Grifo giratorio sobremesa dos aguas serie extra bajo

Low profile spout model double inlet rotating tap
 Robinet giratoire deux eaux modèle extra-bass

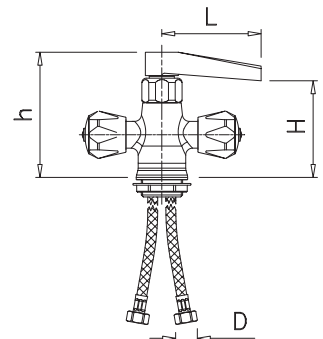

L	H	h	D	litros/min	Kg	Barcode	€
135	115	145	1/2"	17	2,66	463220	147,00

Grifo monomando sobremesa con caño bajo

One handle tap with low profile spout
 Robinet monocommande jet bas



Características:

Por su baja altura están diseñados para ponerlos en los fregaderos que van debajo de las barras de bar.

Characteristics:

Specially designed to be installed on sinks below bar counters.

Caractéristiques:

Spécialement conçu pour être installé dans les éviers sous les comptoirs de bar.

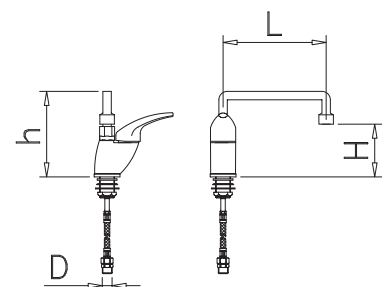

L	H	h	D	litros/min	Kg	Barcode	€
220	90	145	1/2"	21	1,25	463428	139,00

Grifo giratorio sobremesa 1/4 vuelta un agua caño bajo

Single inlet 1/4 turn rotating tap, low spout
Robinet tournant 1/4 tour une eau bec de robinet bas

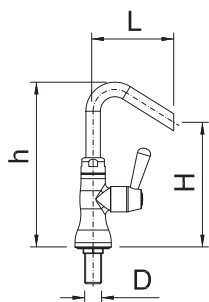





L	H	h	D	 univ./A	 Kg		€
100	145	200	1/2"	22	1,20	463436	85,00

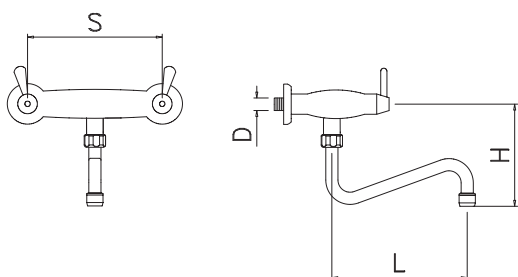

Grifo mural dos aguas 1/4 de vuelta caño bajo

Double inlet 1/4 turn wall tap
Robinet tournant mural 1/4 tour deux eaux







L	H	D	S	 univ./A	 Kg		€
250	120	1/2"	150	20	1,50	463432	99,00

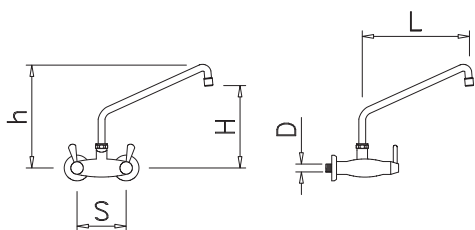

Grifo mural dos aguas cuarto de vuelta

Double inlet 1/4 turn model wall tap
Robinet mural à deux eaux modèle 1/4 de tour



L	H	h	D	S	 univ./A	 Kg		€
250	200	250	1/2"	150	18	1,60	463424	95,00



Grifo mural de codo un agua

Single inlet angled tap
Robinet à coude une eau

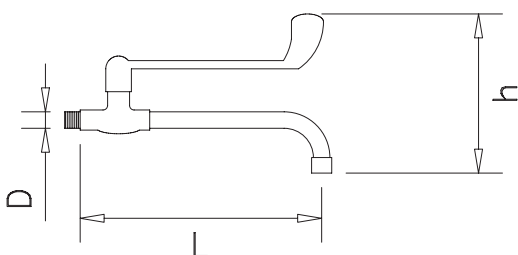

L	h	D	 univ./A	 Kg		€
265	175	1/2"	25	0,65	463202	50,00



Grifo monomando mural de codo dos aguas serie monoblock-elevado

Elevated monoblock model double inlet one handle wall tap elbow functioning
 Robinet de mur monocommande à coude pour deux eaux modèle monoblock-elevado

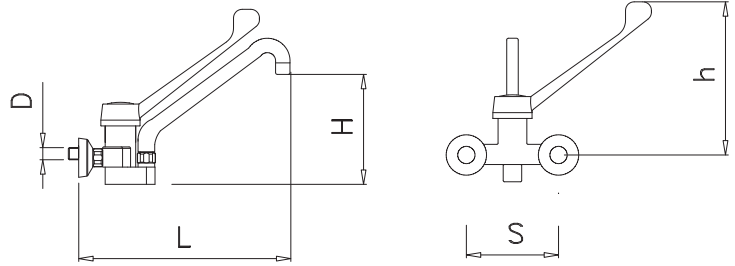

L	H	h	D	S	litro/min	Kg	Barcode	€
300	270	495	1/2"	150	22	3,89	463218	220,00

Grifo monomando mural de codo dos aguas serie monoblock-bajo

Double inlet one handle wall tap elbow functioning, low profile monoblock model
 Robinet mitigeur mural à coude deux eaux série monoblock-bas

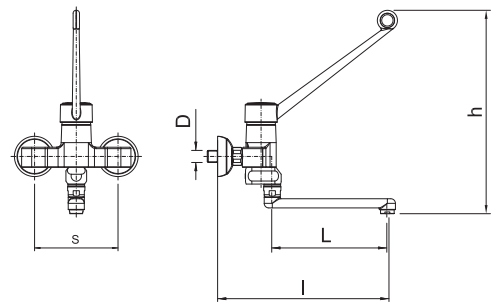

L	H	h	D	S	litro/min	Kg	Barcode	€
200	294	360	1/2"	145	20	4,50	463234	221,00

Grifo monomando mural de codo para dos aguas

Double inlet one handle wall tap elbow functioning
 Robinet de mur monocommande à coude pour deux eaux

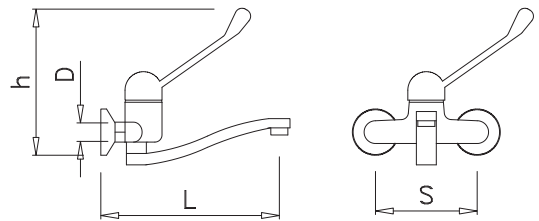

L	h	D	S	litro/min	Kg	Barcode	€
250	240	1/2"	150	20	1,48	463208	72,00

Grifo mural de 1 agua con pomo aislante caño alto

Single inlet long-neck wall tap with insulating tap head
 Robinet mural à une eau avec tête isolante et mitigeur haut

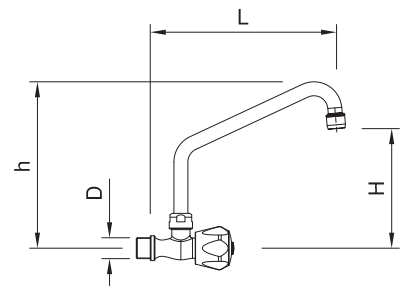

L	H	h	D	litro/min	Kg	Barcode	€
285	155	215	1/2"	25	0,60	463232	60,00

Grifo mural de 1 agua con pomo aislante caño bajo

Single inlet low-neck wall tap with insulating tap head
Robinet mural à une eau avec tête isolante et mitigeur bas

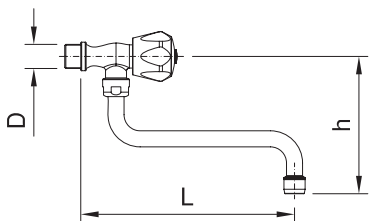

L	h	D				€
285	155	1/2"	25	0,60	463230	60,00



Grifo de sobremesa dos aguas con pomo aislante

Double inlet table tap with insulating head
Robinet sur table à deux eaux avec tête isolante

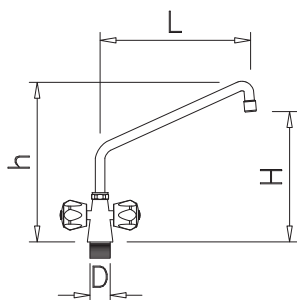

L	H	h	D				€
400	370	440	1/2"	18	2,90	463224	160,00



Grifo de columna orientable sobremesa pomo aislante

Double inlet rotating column tap with insulated head
Robinet orientable sur colonne manette isolante

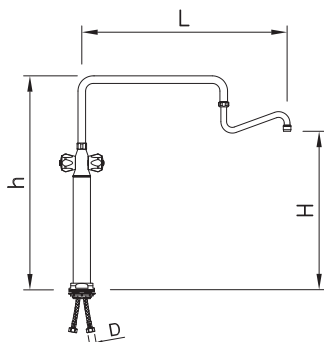





L	H	h	D				€
650	485	665	1/2"	23	4,00	463229	385,00

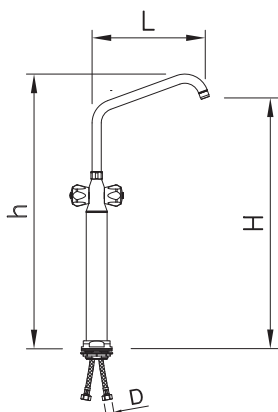

Grifo columna sobremesa 2 aguas pomo aislante

Double inlet column tap with insulated head
Robinet colonne 2 eaux poignée isolante







L	H	h	D					€
300	630	700	1/2"	21	80 °C	6,00	463238	346,00

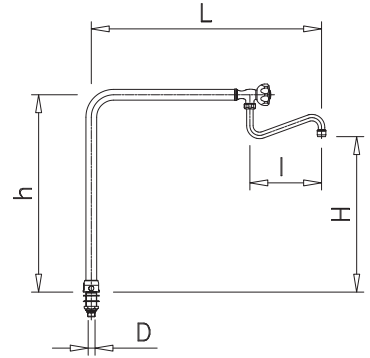

Grifo de columna orientable sobremesa de un agua

Single inlet adjustable column tap
Robinet orientable sur colonne à une eau



L	h	D	I	H	 l/min/2l	 Kg		€
650	550	1/2"	200	430	25	2,8	463210	155,00
700	700	1/2"	250	600	25	3,1	463212	160,00

Grifo monomando sobremesa de columna

One handle column tap
Robinet monocommande sur colonne

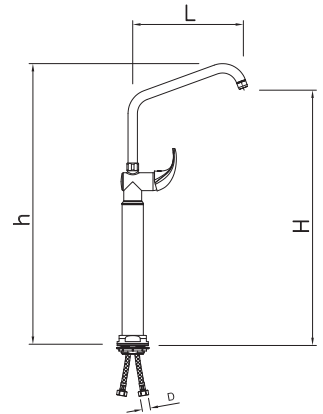

L	H	h	D	 l/min/2l	 Kg		€
285	680	750	1/2"	21	6,0	463228	277,00

Grifo de columna orientable sobremesa 2 aguas monomando

Double inlet one handle adjustable column tap
Robinet orientable sur colonne à deux eaux

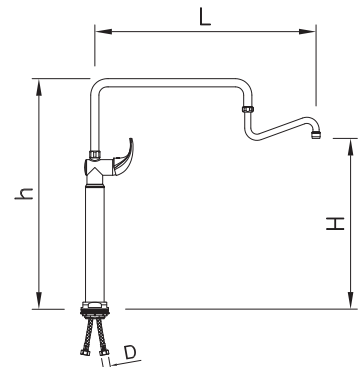

L	H	h	D	 l/min/2l	 Kg		€
650	500	675	1/2"	24	5,0	463213	365,00

Válvula desagüe de 1 1/2" para marmita

1 1/2" drain for pots
Drainage de 1 1/2" pour marmites

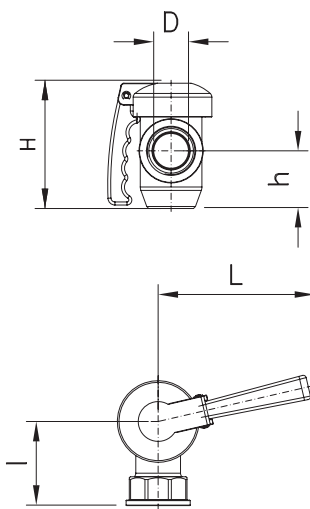

L	H	h	l	D	Kg	Barcode	€
155	130	60	85	1 1/2"	2,5	464802	174,00

Válvula desagüe de 2" para marmita

2" drain for pots
Drainage de 2" pour marmites

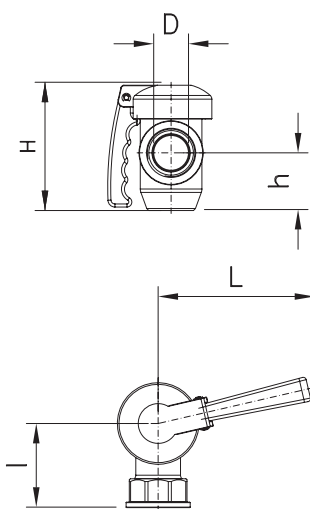

L	H	h	l	D	Kg	Barcode	€
185	160	75	90	2"	2,5	464804	185,00

Válvula desagüe de 1" para marmita

1" drain for pots
Drainage de 1" pour marmites

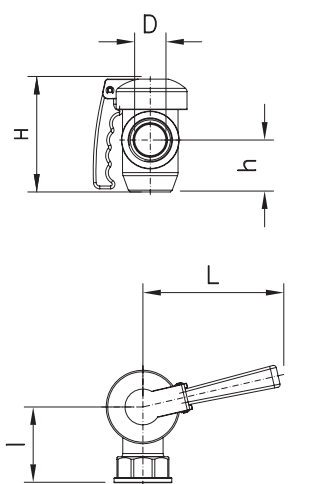

L	H	h	l	D	Kg	Barcode	€
120	95	50	55	1"	1,0	464806	112,00

Grifo Clinic Expert
Expert Clinic tap
Robinet Expert Clinic



Características:

El funcionamiento "sin contacto", facilita una mayor higiene al lavarse las manos así como una fácil limpieza del lavabo. Sus materiales inhibidores de gérmenes y el enjuague higiénico ayudan a evitar la indeseable germinación. El caudal de agua libre de plomo y bacterias cumple con todas las nuevas normas de agua potable.

Characteristics:

The operation "Touchless" enables the highest hygiene when washing your hands as well as an easy clean of the basin. Its anti-sprouting materials and its hygienic shape will avoid the presence of pathogens. Lead-free and antibacterial spout that will allow the user meet the latest drinking water regulations.

Caractéristiques:

L'opération "Touchless" permet plus d'hygiène dans le lavage les mains, ainsi que un nettoyage plus facile du bassin. Ses matériaux inhibiteurs de germination et sa forme hygiénique permettra d'éviter la présence de pathogènes. Sans plomb et avec le bec antibactérien qui permet à l'utilisateur de répondre aux dernières normes de l'eau potable.

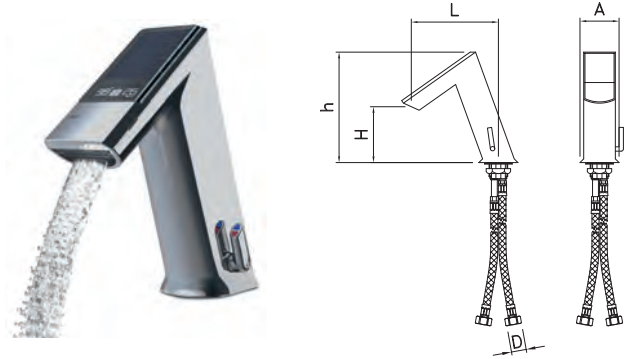

L	H	h	A	D	Kg	Barcode	€
147	94	178	63	3/8"	1,9	460809	974,00

Kit electrónico para lavamanos y fregaderos funcionamiento a pilas

Electronic battery working kit for washbasins and sinks
Kit électronique pour lave-mains et éviers fonctionnement à piles

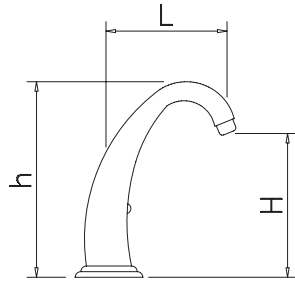

Provisto de mezclador antirretorno
Supplied with no-return mixing valve
Munies de valve antiretour mélangeuse

L	H	h	Unit/Alt	Kg	Barcode	€
115	140	180	15	1,8	060804	299,00

Grifo monoblock electrónico con selector de temperatura. Funcionamiento a pilas

Electronically-operated mono block tap with temperature selector. Battery operated
Robinet électronique monobloc avec sélecteur de température. Fonctionnement à piles

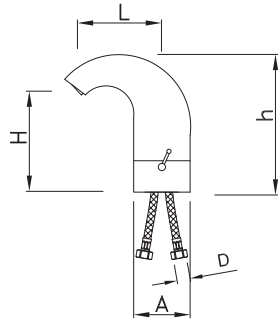

L	A	H	h	D	Unit/Alt	Kg	Barcode	€
135	70	166	200	1/2"	15	3,5	460806	350,00

Grifo mural electrónico. Funcionamiento a pilas

Electronically-operated wall tap. Battery operated
Robinet électronique au mur. Fonctionnement à piles



Funcionamiento a pilas
Batteries functioning
Fonctionnement à piles

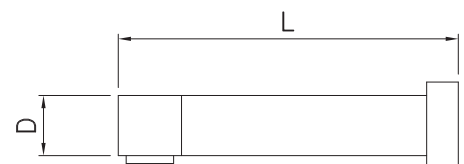

L	D	Unit/Alt	Gr	Barcode	€
215	1/2"	15	300	460808	261,00

Caño fijo
Fixed spout
Jet fixe

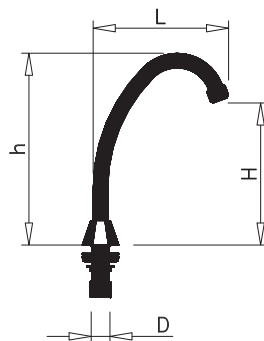

L	h	D	H	Gr	Barcode	€
130	245	1/2"	180	420	461002	40,00

Caño giratorio
Rotating spout
Jet giratoire

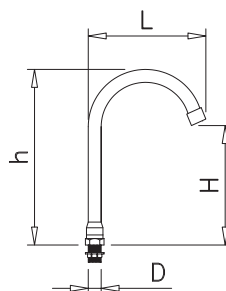

L	h	D	H	Gr	Barcode	€
145	223	1/2"	140	246	461008	40,00

Caño giratorio extra bajo
Low profile rotating spout
Giratoire extra bas

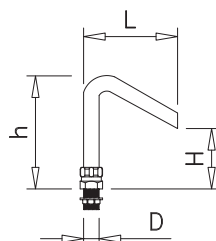

L	h	D	H	Gr	Barcode	€
113	130	1/2"	70	280	461010	38,00

Caño ducha extraíble
Detachable spout for shower fitting
Jet detachable pour douche

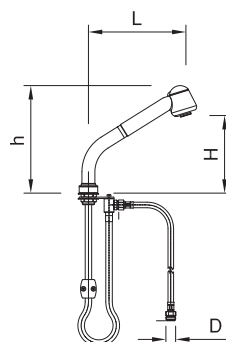

L	H	h	D	W mm	Kg	Barcode	€
210	167	230	1/2"	18	1	462862	175,00

Caño mural giratorio
Wall-mounted rotating spout
Jet mural giratoire

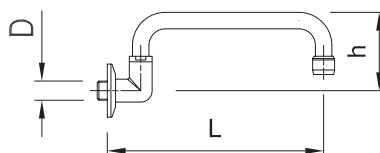

L	h	D	W mm	Gr	Barcode	€
285	86	1/2"	17	350	461012	62,00

Pedal mezclador de agua fría y caliente con palanca de bloqueo H-H-H- 1/2"

H-H-H 1/2" hot and cold water mixer pedal with blocking lever
Pédale mélangeuse eau froide et chaude H-H-H 1/2" avec levier de blocage



L	A	H	Kg	Barcode	€
350	80	93	2,70	460606	231,00

Pedal de un agua M-M de 1/2"

M-M 1/2" single inlet water pedal
Pédale à une eau M-M 1/2"



Gr	Barcode	€
485	460602	55,00

Pedal mezclador de agua fría y caliente M-M-M de 1/2"

M-M-M 1/2" hot and cold-water mixer pedal
Pédale mélangeuse eau froide et eau chaude M-M-M 1/2"



Gr	Barcode	€
770	460604	98,00

Pulsador no temporizado M-M de 1/2"

M-M 1/2" push-button not timer
Bouton-poussoir non temporisé M-M 1/2"



Gr	Barcode	€
400	460404	40,00

Pulsador temporizado M-M de 1/2"

M-M 1/2" push-button timer
Bouton-poussoir temporisé M-M 1/2"



Gr	Barcode	€
400	460410	40,00

Palanca un agua M-M 1/2"

Twist waste handle tap M-M 1/2"
Robinet à levier M-M 1/2"



Kg	Barcode	€
1,35	463802	107,00

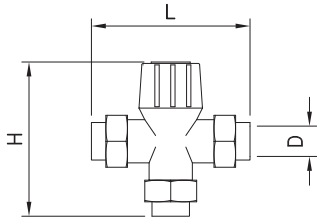

L	H	D	Gr	Barcode	€
130	115	1/2"	620	461402	87,00

Válvula mezcladora termostática H-H-H de 1/2"

H-H-H 1/2" thermostatic mixing valve
Valve mélangeuse thermostatique H-H-H 1/2"

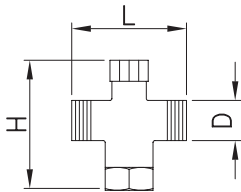

L	H	D	Gr	Barcode	€
60	70	1/2"	150	461604	25,00

Válvula mezcladora antiretorno M-H-M de 1/2"

M-F-M 1/2" no-return mixing valve
Valve mélangeuse antiretour M-H-M 1/2"

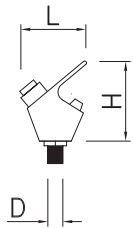

L	H	D	Gr	Barcode	€
65	85	3/8"	125	464250	25,00

Grifo pulsador para fuente

Push-button tap for fountain
Robinet pousseur pour fontaine

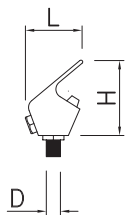

L	H	D	Gr	Barcode	€
65	82	3/8"	115	464248	32,00

Grifo para fuente de agua sin pulsador

Tap for drinking fountain without push-button
Robinet pour fontaine sans bouton-pousseur

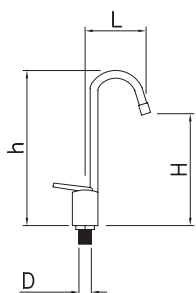

L	H	h	D	Gr	Barcode	€
75	145	200	3/8"	130	464252	23,00

Grifo llenajarras

Tap to fill up jars
Robinet pour remplir pots



Grifo temporizado para urinario

Tap timer for urinals
Robinet temporeise pour urinoirs

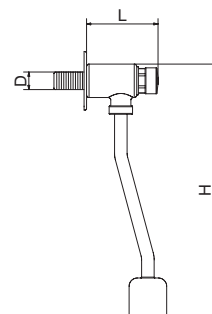

L	H	D	Gr	Barcode	€
72	210	1/2"	400	464604	34,00

Grifo electrónico temporizado para urinario. Funcionamiento a pilas

Electronically operated tap timer for urinals. Battery operated
Robinet electronique temporeise pour urinoirs. Fonctionnement à piles



Funcionamiento a pilas
Batteries functioning
Fonctionnement à piles

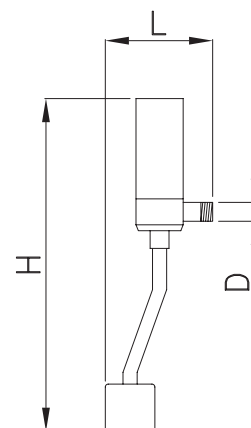

L	H	D	Kg	Barcode	€
60	290	1/2"	1,2	464610	286,00

Fluxómetro para WC

Push button timer for WC
Robinet temporeise pour WC

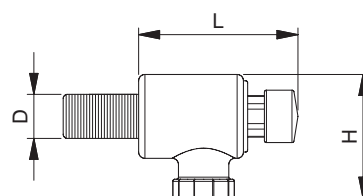

L	H	D	Gr	Barcode	€
100	80	3/4"	900	464606	62,00

Ducha de gran alcance H de 1/2"

Long-reach shower
Douche à grande portée



Longitud del latiguillo 2.000 mm.
Hose length 2.000 mm.
Longueur du flexible 2.000 mm.

13,5	60 °C	900	463002	25,00

Ducha horno H de 1/2"

Shower for oven
Douche pour four



Longitud del latiguillo 2.000 mm.
Hose length 2.000 mm.
Longueur du flexible 2.000 mm.

11	60 °C	2,45	463004	74,00

Ducha horno enrollable H de 1/2"

Roll-up shower for oven
Douche pour four enrollable

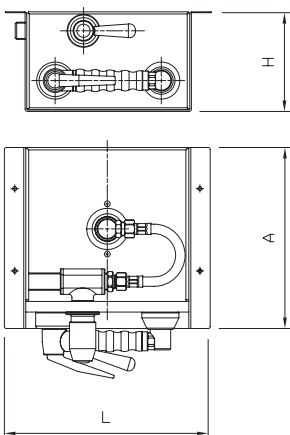

L	A	H		
250	115	220	10	55 °C
			5	463006
				340,00



Longitud del latiguillo 1.700 mm.
Hose length 1.700 mm.
Longueur du flexible 1.700 mm.

Ducha horno enrollable bajo encimera

Under worktop roll-up shower for oven
Douche enrollable sous plan pour four



Longitud del latiguillo 1.700 mm.
Hose length 1.700 mm.
Longueur du flexible 1.700 mm.

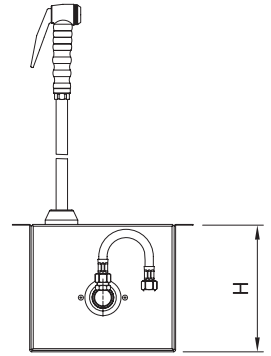
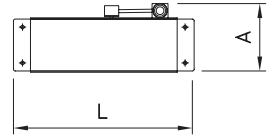

L	A	H	litros/min	°C max	Kg	Barcode	€
230	108	200	13	55 °C	4	463008	288,00

Ducha para horno pulsador

Shower for oven, push button operation
Douche pour four, fonctionnement à poussoir



Longitud del latiguillo 2.000 mm.
Hose length 2.000 mm.
Longueur du flexible 2.000 mm.

litros/min	°C max	Kg	Barcode	€
11	60 °C	2,50	463005	60,00

Grifo manguera enrollable serie profesional

Professional roll-up faucet hose
Robinet-tuyau d'arrosage enrollable professionnel



Longitud de manguera: 12 mts.
Hose length: 12 mts.
Longueur du tuyau: 12 mts.

El precio NO incluye el grifo rociador o piña.
Faucet not included in the price.
Le prix ne inclut pas le robinet d'arrosage.

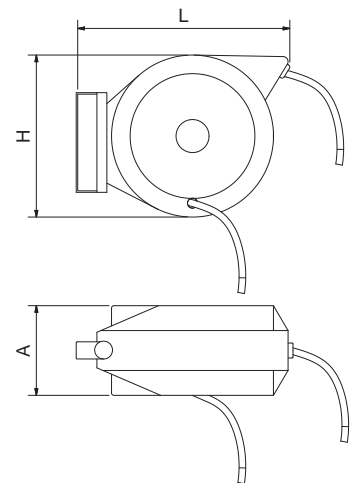

L	A	H	Ø	litros/min	°C max	Kg	Barcode	€
450	180	350	3/8" *	12	55 °C	7,50	064006	275,00

* Se incluye conexión de 1/2" M.
1/2" M link included.
Comprend adapteur 1/2" M.

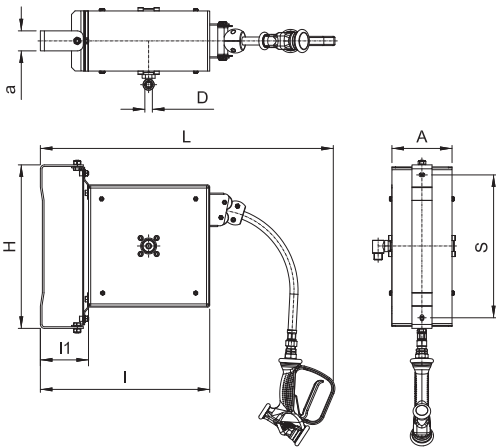

Grifo manguera enrollable inoxidable serie compacto

Compact roll-up faucet hose
Robinet enrouleur inoxydable série compacte



Longitud de manguera: 5 mts.
Hose length: 5 mts.
Longueur du tuyau: 5 mts.



L	I	H	D	S	A	a	I1				€
730	425	410	1/2"	356	150	50	120	13	11,00	464008	1.073,00

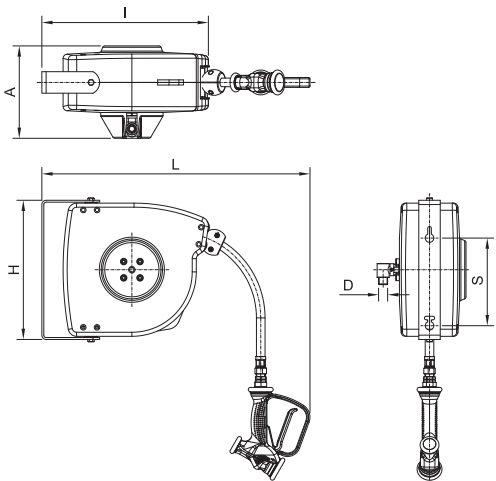

Grifo manguera enrollable serie profesional plus

Professional plus roll-up faucet hose
Robinet enrouleur professionnel plus



Longitud de manguera: 5 mts.
Hose length: 5 mts.
Longueur du tuyau: 5 mts.



L	I	H	D	S	A				€
620	390	320	1/2"	204	215	13	7,00	464010	866,00

Puesto de lavado y desinfección

Sanitary work station
Poste de lavage et de désinfection

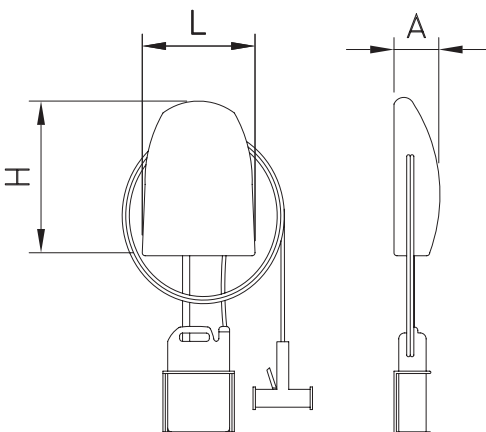

Características:

Soporte inox. para 1 garrafa de 5 litros.

Characteristics:

Inox holder for 5 litres tank

Caractéristiques:

Support inox pour réservoir de 5 litres



Longitud de manguera: 15 mts.
Hose length: 15 mts.
Longueur du tuyau: 15 mts.



L	A	H			€
270	80	400	1,5	465602	553,00

Grifo manguera enrollable serie básico

Basic roll-up faucet hose

Robinet-tuyau d'arrosage enrollable basique

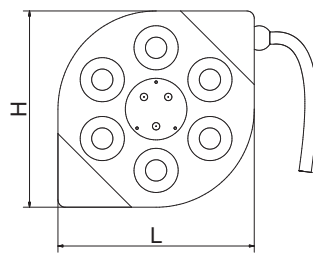
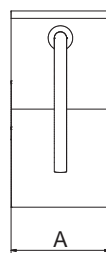
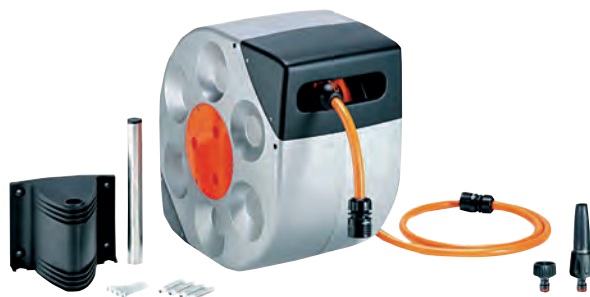

Longitud de manguera: 10 mts.
Hose length: 10 mts.
Longueur du tuyau: 10 mts.

L	A	H	∅	litros/l	max °C	Kg	Barcode	€
400	200	400	1/2"	12	40 °C	11,5	464006	195,00

Grifo manguera enrollable serie inoxidable

Stainless roll-up faucet hose

Robinet-tuyau d'arrosage enrollable inoxydable



Construcción en acero inoxidable extrafuerte
Pivotante 180°
Máxima presión 5 bar

All heavy duty stainless steel construction
180° pivoting
Max. press. 5 bar

Construit en acier inoxydable extra-fort
Pivotement 180°
Max. press. 5 bar

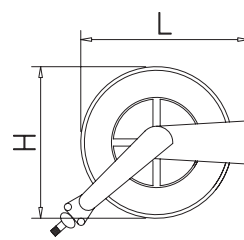
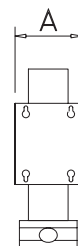

Longitud de manguera: 15 mts.
Hose length: 15 mts.
Longueur du tuyau: 15 mts.

El precio incluye el grifo rociador o piña.
Faucet included in the price.
Le prix inclut pas le robinet d'arrosage.

L	A	H	∅	litros/l	max °C	Kg	Barcode	€
533	235	438	1/2"	13	55 °C	22	464004	1.050,00

Accesorios para grifos de manguera

Taps accessories for roll-up faucets
Robinetterie accessoires pour robinet-tuyau d'arrosage



Adaptador H de 3/8" a M de 1/2"
M 3/8" to F 1/2" adaptor
Adaptateur M 3/8" - H 1/2"

50 464055 **4,50**



Adaptador H de 1/2" a H de 1/2"
F 1/2" to F 1/2" adaptor
Adaptateur H 1/2" - H 1/2"

60 464054 **5,50**



Conector rápido universal H1/2"
F 1/2" Universal quick connector
Connecteur rapide universel F 1/2"

75 464062 **31,00**



Pistola rociadora de pulverización regulable H 1/2"
Pistol shower F 1/2"
Pistolet H 1/2"

970 464058 **126,00**



Pistola con lanza rociadora H 1/2"
Pistol and nozzle shower F 1/2"
Pistolet et lance F 1/2"

615 064050 **187,00**



Piña para grifo ducha
Head shower
Douche

700 462806 **79,00**



Piña de acero inoxidable para grifo ducha
Stainless steel head shower
Douche d'acier inoxydable

700 462807 **130,00**



Equilibrador
Spring balancer
Équilibrateur

500 463030 **69,00**

Monomando lavabo

One handle mixer for basin
Mélangeur lavabo



Novedad
ew
ouveau

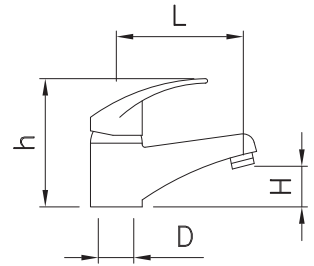

L	H	h	D	 1/1.5/2.1	 Gr		€
103	44	111	1/2"	16	570	464616	30,50

Grifo para lavabo de 1 agua

One inlet basin tap
Robinet pour lavabo à une eau

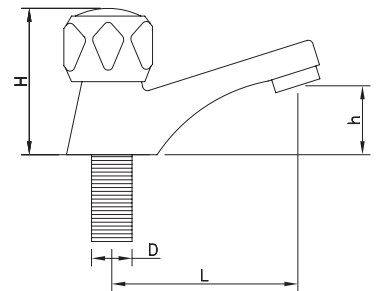

L	H	h	D	 1/1.5/2.1	 Gr		€
100	30	80	1/2"	16	0,25	464608	31,00

Monomando bidé

One handle mixer for bidet
Mélangeur bidet



Novedad
ew
ouveau

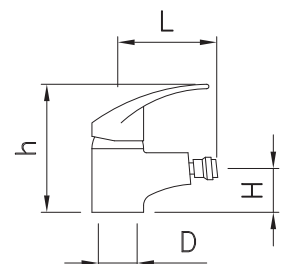

L	H	h	D	 1/1.5/2.1	 Gr		€
95	42	114	1/2"	16	580	464618	33,50

Grifo temporizado un agua
Single inlet tap timer
Robinet temporisé à une eau

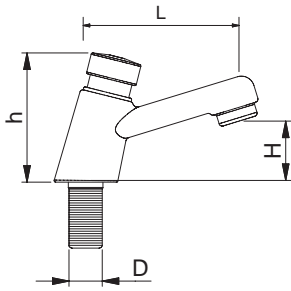

L	H	h	D				€
100	30	80	1/2"	0,67	0,67	464602	44,00



Grifo temporizado dos aguas
Double inlet tap timer
Robinet temporisé à deux eaux

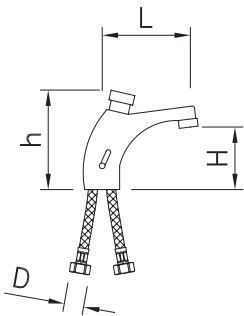

L	H	h	D				€
107	85	125	1/2"	15	1,25	464612	179,00



Monomando ducha
One handle mixer for shower
Mélangeur douche

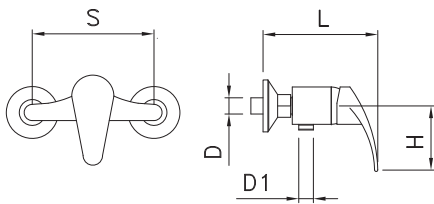

L	H	D	D1	S				€
143	85	3/4"	1/2"	150	17	684	464622	40,00



Monomando baño/ducha
One-handle mixer for bath/shower
Mélangeur baignoire

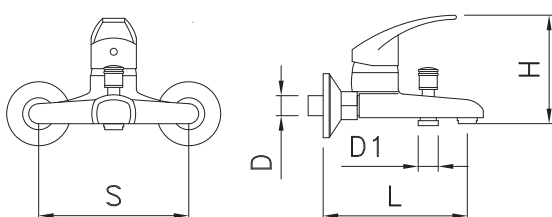

L	H	D	D1	S				€
144	111	3/4"	1/2"	150	17	888	464620	50,00



Conjunto de ducha, grifo monomando y mástil

Wall-mounted rainfall tub shower tap set
Ensemble robinet douche mitigeur fixation mural

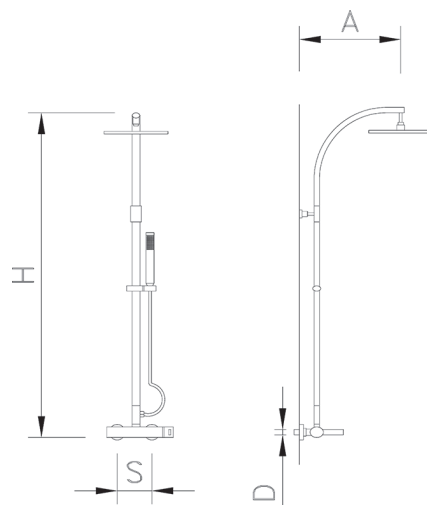

A	H	S	D	 lit/min	 Kg		€
385	1.300	150	1/2"	6	4,00	465802	414,00

Conjunto de ducha y pulsador profesional

Professional push-button shower set
Ensemble douche bouton-poussoir professionnelle

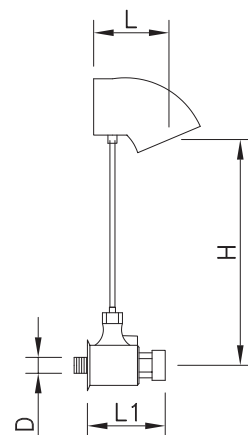



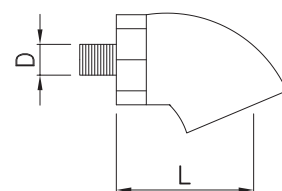

L	L1	H	D	 lit/min	 °C max	 Kg		€
75	80	865	1/2"	5	80 °C	1,80	465804	178,00

Rociador de ducha

Shower head
Pomme de douche



L	D	 lit/min	 °C max	 Gr		€
60	1/2"	5	80 °C	450	465806	42,00

	Modelo Model Model	Gr	Barcode	€	
	Piña para grifo ducha Head shower Douche	700	462806	79,00	
	Piña de acero inoxidable para grifo ducha Stainless steel head shower Douche d'acier inoxydable	700	462807	130,00	
	Juego de muelle y juntas para piña de grifo ducha Spring and joints set for shower head Ensemble de ressort et joints pour poignée de robinet douchette	30	462880	9,40 N	
	Latiguillo inox. plastificado para grifo ducha Flexible rubber hose inox for shower taps Flexibles en d'acier inoxydable pour robinet douche	800 mm	250	462851	21,00 N
		1.100 mm	350	462808	17,00
		1.200 mm	350	462852	22,00
		1.500 mm	350	462854	24,00
		400 mm	100	461202	4,00
	Latiguillos flexibles en malla de acero inoxidable H-H de 1/2" H-H 1/2" stainless-steel flexible hoses Flexibles en maille d'acier inoxydable H-H d'1/2"	600 mm	120	461206	5,00
		700 mm	140	461208	5,00
		800 mm	180	461210	6,00
		900 mm	200	461212	7,00
		1.200 mm	240	461214	6,50
		1.500 mm	345	461216	8,00
	Muelle para grifo ducha Spring for table shower fitting Ressort pour robinet douche	1.200	462804	35,00	
	Mástil para grifo ducha Table shower fitting support Tuyau pour robinet douche	790 mm	930	462802	45,00
		620 mm	800	462800	43,00
	Mástil extra corto para grifo ducha Extra-short table shower fitting support Tuyau extra court sur table pour robinet douchew	210 mm	270	462801	39,00
	Mástil con caño para grifo ducha Table shower fitting support with spout Tuyau pour robinet douche avec jet	790 mm	1.360	462803	108,00
	Pomo de repuesto para mástil con caño Spare flow knob for table shower fitting support Sélecteur de sortie pour robinet douchette	120	462875	9,00	
	Tope de muelle para grifo ducha Top for table shower fitting spring Arrêt pour robinet douche	140	462805	6,50	
	Tirante, soporte a pared para grifo ducha Wall-rod for shower fitting Tringle au mur pour robinet douchette	220	462814	25,00	
	Soporte piña modelo apoyar Shower-head holder. Supporting model Support pour poignée. Modèle appui	220	462876	25,00	



Soporte piña modelo gancho
Shower-head holder. Hook model
Tringle au mur pour robinet douche 463052

130 462878 17,00



Tirante a pared para grifo ducha 463052
Wall rod for shower fitting 463052
Tringle au mur pour robinet douche 463052

130 462848 33,00



Tornillo allen M6x12 (tope de muelle y tirante a pared)
Allen bolt M6x12 (spring top and wall rod)
Vis allen M6x12 (arrêt pour robinet et tringle au mur)

2 462824 0,40



Tornillo allen M6x8 (Soporte piña)
Allen bolt M6x8 (shower head support)
Vis allen M6x8 (support de pomme)

1 462826 0,40



Tuerca unión mástil y válvula grifo ducha
Joint nut for shower fitting support and shower tap valve
Écrou de joint pour tuyau et valvule pour robinet douche

40 462816 3,30



Juego de juntas para el mástil del grifo ducha
Joints set for shower fitting support
Conjoint de joints pour tuyau de robinet douche

1 462834 2,00



Conjunto sujeción inferior válvula de un agua
Lower fixing set for single inlet valve
Conjoint de fixation inférieure pour valvule à une eau

35 462836 4,00



Conjunto sujeción inferior válvula monomando dos aguas
Lower fixing set for double inlet one handle valve
Conjoint de fixation inférieure pour valvule monocommande à deux eaux

30 462840 5,00



Conjunto sujeción inferior válvula dos aguas
Lower fixing set for double inlet valve
Conjoint de fixation inférieure pour valvule à deux eaux

85 462838 4,30



Conjunto sujeción inferior para válvula 462406
Lower fixing set four double inlet one handle valve
Conjoint de fixation inférieure pour valvule mitigeur à deux eaux

95 462841 9,50



Latiguillo inferior para grifo ducha dos aguas
Lower hose for table double inlet shower fitting
Flexible intérieur pour robinet douche à deux eaux

90 462820 4,30

95 462822 4,30



Palanca para válvula monomando dos aguas
Handle for double inlet one handle valve
Commande pour valvule monocommande à deux eaux

130 462842 10,00



Caño bajo para válvulas
Low spout for valves
Jet bas pour valves

250 462866 29,00



Caño para válvula monomando dos aguas
Spout for connecting to one handle mounted valve
Jet adaptable au robinet monocommande à deux eaux

530 462844 53,00

	Caño acoplable a mástil de grifo ducha 250mm. Attachable spout for shower fitting support 250mm. Jet adaptable à tuyau pour robinet douche 250mm.	430	462850	35,00	
	Caño acoplable a grifo ducha Spout for connecting to shower fitting Jet adaptable au robinet douche	1.500	462812	85,00	
	Caño acoplable a grifo ducha Spout for shower fitting Bec de robinet adaptable à douchette	1.200	462813	91,00	
	Válvula doble entrada, dos aguas 1/4 vuelta Double inlet valve for deck mounted faucet, 1/4 turn Valve double entrée, 2 eaux 1/4 de tour	1.600	462418	140,00	N
	Válvula doble entrada, dos aguas, monomando codo High neck double inlet one handle tap, elbow functioning Valve double entrée, 2 eaux, mélangeur à coude	4.000	462420	338,00	N
	Válvula monomando dos aguas Double inlet one handle valve Valve monocommande à deux eaux	2.400	462406	185,00	
	Pomo corto para válvula 462406 Spare flow knob for table shower fitting support Sélecteur de sortie pour robinet douchette	86	462874	15,00	N
	Válvula monomando dos aguas Double inlet one handle valve Valve monocommande à deux eaux	963	462410	115,00	
	Válvula monomando dos aguas Double inlet one handle valve Valve monocommande à deux eaux	1.800	462412	140,00	
	Válvula mural monomando dos aguas One handle wall mounted valve Valve monocommande de mur à deux eaux	1.750	462408	153,00	
	Válvula mural dos aguas con levas 1/4 de vuelta Double inlet 1/4 turn wall-mounted valve Valve murale avec pomes 1/4 de tour	1.900	462416	74,00	
	Válvula dos aguas con levas 1/4 de vuelta Double inlet 1/4 turn valve Valve avec pomes 1/4 de tour	1.500	462414	77,00	
	Válvula de un agua Single inlet valve Valve à une eau	550	462402	58,00	



Válvula de dos aguas
Double inlet valve
Valve à deux eaux

1.250 462404 **63,00**



Juego válvulas antirretorno para grifo monomando dos aguas
Anti-return valves set for double inlet one handle tap
Conjoint de valvules anti-retour pour robinet monocommande à deux eaux

85 462846 **17,00**



Adaptador para mástil
Shower support adaptor
Adaptateur pour support de douche

55 462832 **6,00**



Piña para grifo monomando ducha extensible
Shower head for one handle extending shower tap
Pomme pour robinet monocommande douche extensible

190 463250 **49,00**



Latiguillo lastrado para grifo monomando ducha extensible
Weighted hose for one handle extending shower tap
Flexible lesté pour robinet monocommande douche extensible

437 463252 **26,00**



Leva para grifo monomando ducha extensible
Handle for one handle extending shower tap
Command pour robinet monocommande douche extensible

145 463260 **22,00**



Kit de juntas para pulsador temporizado
Gasket kit for push button timer
Kit de joints pour bouton-poussoir temporisé

5 460450 **3,20**

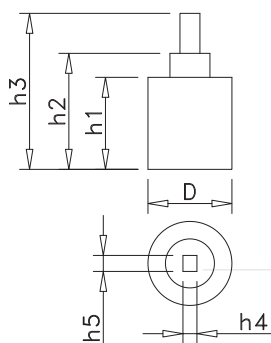

*Consultar para modelos descatalogados.

* For discontinued models contact us

* Consulter pour des modèles hors-catalogue

	D	H1	H2	H3	H4	H5	Gr	Barcode	€
--	---	----	----	----	----	----	----	---------	---

Cartucho para válvula Spare cartridge for valve Cartouche de rechange pour valve	40	32	42	64	10	10,5	65	462830	20,00
---	----	----	----	----	----	------	----	--------	--------------



463051	463064	463066	463072	463074
463038	463040	463228	463213	465206
463206	463236	463216	463227	465208
462412	462408	464614	463602	463204*
463208*				

	D	H1	H2	H3	H4	H5	Gr	Barcode	€
--	---	----	----	----	----	----	----	---------	---

Cartucho para válvula Spare cartridge for valve Cartouche de rechange pour valve	40	43	54	75	10	10,3	78	463082	22,00
---	----	----	----	----	----	------	----	--------	--------------

463428	463234	463216*	462406*	463050	463062
463214	463228	463218*			

D H2 H3 H4 H5 Gr  €

Cartucho para válvula
Spare cartridge for valve
Cartouche de rechange pour valve

18,5	37	51,6	7,6	7,6	64	462864	13,00
------	----	------	-----	-----	----	--------	--------------

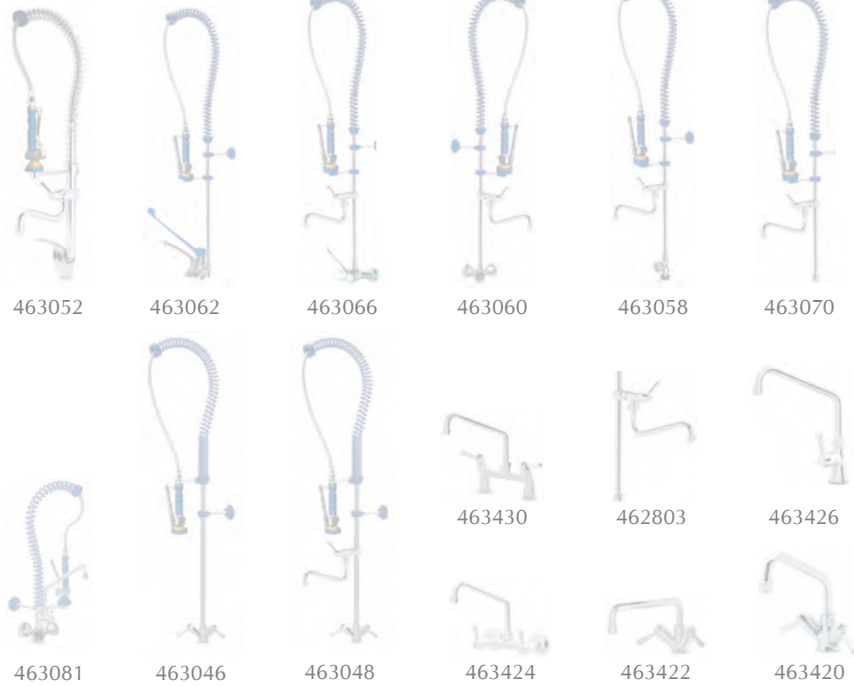

Cartuchos para modelos descatalogados

Cartridges for discontinued models
Cartouches pour des modèles hors-catalogue

D H1 H2 H3 H4 H5 Gr  €



Cartucho para válvula
Spare cartridge for valve
Cartouche de rechange pour valve

42	46	58	78	7	8	90	462828	47,00
----	----	----	----	---	---	----	--------	--------------



Cartucho para válvula
Spare cartridge for valve
Cartouche de rechange pour valve

41	49	61	81	6,4	7	93	463258	45,00
----	----	----	----	-----	---	----	--------	--------------





Piña para ducha de gran alcance M 1/2"
Shower head for long-reach shower M 1/2"
Pomme pour douche à grande portée M 1/2"

85 463020 **26,00**



Latiguillo para ducha de gran alcance 2000 mm H-H 1/2"
Hose for long-reach shower F-F 1/2"
Flexible pour douche a grande portée F-F 1/2"

230 463022 **13,00**



Piña para ducha horno M 1/2"
Shower head for oven shower M 1/2"
Pomme pour douche de four M 1/2"

250 463024 **54,00**



Latiguillo para ducha horno 2000 mm H-H 1/2"
Hose for oven shower F-F 1/2"
Flexible pour douche de four F-F 1/2"

530 462810 **26,00**



Latiguillo para ducha horno enrollable 463006 y 463008
Roll hose for oven shower 463006 & 463008
Rouler pour douche de four 463006 et 463008
L = 1.700 mm.

280 463010 **29,00**



Juego de juntas para grifo manguera serie profesional 8 m.
Joints set for professional faucet hose 8 m.
Conjoint de joints pour robinet-tuyau d'arrosage modèle professionnel 8 m.

30 464068 **69,00**



Manguera de repuesto 8 m para grifo de manguera serie profesional.
Hose complement 8 m.
Tuyau d'arrosage de rechange 8 m.

2.500 464064 **108,00**



Manguera de repuesto 15 m. para grifo manguera serie inox.
Hose complement 15 m.
Tuyau d'arrosage de rechange 15 m.

14.000 464066 **189,00**



Manguera de repuesto 12 m. para grifo manguera serie profesional
Hose complement 12 m.
Tuyau d'arrosage de rechange 12 m.

14.000 464074 **103,00**



Lanza rociadora M 1/2"
Nozzle shower M 1/2"
Lance M 1/2"

165 464060 **69,00**



Pistola para lanza de acero inoxidable H 1/2"
Pistol for stainless steel nozzle F1/2"
Pistolet pour lance en acier inoxydable F1/2"

450 464070 **58,00**



MOBILIARIO

Neutral furniture
Meubles neutres

NOVEDADES

News

Nouveautés

Mesas centrales Central tables Tables centrales.....	279	Mesas centrales con reborde y desagüe Centre tables with raised edge and drain Tables centrales avec rebord et trou d'écoulement.....	297
Mesas murales Wall-side tables Tables murales.....	279	Mesas murales con reborde y desagüe Wall-side tables with raised edge and drain Tables murales avec rebord et trou d'écoulement.....	297
Mesas murales con puertas Wall-side tables with doors Tables murales avec portes.....	280	Estanterías suspendidas Hanging wall shelves Étagères suspendues.....	302
Mesas murales con puertas y cajones Wall-side tables with doors and drawers Tables murales avec portes et tiroirs.....	281	Kit de fijación a techo para estanterías suspendidas Ceiling fixing kit for hanging shelves Kit de montage pour plafond pour étagères suspendues.....	302
Mesa mural con cartelas Wall fitted table with brackets Table murale avec équerres.....	281	Peto lateral reversible para mesas Reversible side upstand for tables Dossieret latéral réversible pour tables....	304
Mesas de preparación y lavado Preparation and cleansing tables Tables de préparation et de lavage.....	284	Tapa juntas de unión para mesas y fregaderos Stainless steel flashing for tables and sinks Couvre-joint pour union de tables et évier.....	305
Mesas murales de cajones Wall-side tables with drawers Tables murales à tiroirs.....	285	Armarios de puertas correderas Cupboards with sliding doors Armoires à portes coulissantes.....	306
Mesa de terraza Terrace working table Table Terrasse.....	288	Armarios de puertas abatibles Cupboards with hinged doors Armoires à portes ouvrantes.....	306
Mesa barman Barman table Barman tableau.....	289	Armario de esquina derecha con puertas abatibles Right corner cabinet with hinged doors Armoire d'angle à droite avec portes ouvrantes.....	307
Isla de cocina inox con encimera de madera Kitchen island with wooden worktop Île de cuisine inox avec plan de travail en bois.....	290	Armario de esquina izquierda con puertas abatibles Left corner cabinet with hinged doors Armoire d'angle à gauche avec portes ouvrantes.....	307
Isla de cocina inox con encimera de granito Kitchen island with granite worktop Île de cuisine inox avec plan de travail en granit.....	290	Atril de acero inoxidable Stainless steel desk Pupitre en acier inoxydable.....	310
Mesa central inox con encimera de cristal translúcido Inox center table with translucent glass worktop Table centrale inox avec plan de travail en verre.....	290	Contenedor para transporte de hielo Trolley for ice transportation Conteneur à ordures.....	313
Punto de venta portátil de jamones Mobile sale point of hams Point de vente de jambon portable.....	291	Contenedor para hielo Trolley for ice transportation Conteneur à ordures.....	314
Estante abatible de fibra para punto de venta portátil de jamones Polyethylene hinged shelf for mobile sale point of hams Étagère ouvrante en fibre pour point de vente de jambon portable.....	292	Puesto pescadero encimera polietileno Fish preparation table with polyethylene worktop Table de preparation de poisson dessus en polyéthylène.....	324
Mesa jamonera RT-2D Ham table RT-2D Table porte-jambon RT-2D.....	292	Puesto pescadero modelo sencillo Fish preparation table simple model Table de préparation de poisson modèle simple.....	324
Mesa jamonera RT-3D Ham table RT-3D Table porte-jambon RT-3D.....	293	Mesa para marisco Seafood table Table pour fruits de la mer.....	325
Mesas centrales encimera de polietileno Centre tables with polyethylene worktop Tables centrales dessus en polyéthylène.....	294	Módulo expositor de frutas y verduras Display counter for fruits and vegetables Module d'exposition pour fruits et légumes.....	327
Mesas de preparación centrales Centre preparation tables Tables de préparation centrales.....	295	Campana extractora mural acero inoxidable Wall-mounted stainless steel exhaust hood Hotte de cuisine murale en acier inoxydable.....	337
Mesas de preparación murales Wall-side preparation tables Tables de préparation murales.....	296	Filtro inoxidable para campana extractora industrial Stainless steel filter for commercial exhaust hood Filtre inox pour hotte de cuisine industrielle.....	337





Detalle de cajón acoplado.
Fixed drawer coupled.
Détail de tiroir couplé.

Características de fabricación:



Totalmente fabricadas en acero inoxidable.
Encimera reforzada e insonorizada de 1,5 mm de espesor.
Bastidores inferiores de refuerzo bajo encimera en acero inoxidable.
Bastidor preparado para incorporar entrepaños sin la utilización de herramientas.
Patas de 40 x 40 mm desplazadas para curva sanitaria, acabado brillante.
En la fabricación de nuestras mesas no empleamos madera.
Se adaptan a cualquier desnivel del suelo ya que disponen de pies regulables.
Opcionalmente se pueden instalar los siguientes accesorios:

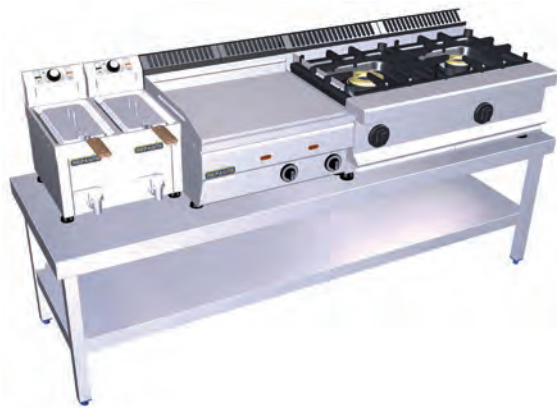

Cajones y tolvas de café	462
Papelera lateral	378
Portacuchillos	132
Ruedas	466
Fibras de polietileno	80
Contenedores de desperdicios	368
Tolva de desbarasado	435
Fregaderos soldados	305
Esterilizadores de cuchillos	355



Los modelos con este distintivo pueden fabricarse con altura de 600 mm para cocinas serie snack o modular, sin alterar el precio. Consultar plazo de entrega.
The models with this badge can be manufactured with height 600 mm. for snack or modular stoves without price increasing. Ask delivery time.
Les modèles avec cet insigne peuvent être fabriqués avec hauteur 600 mm pour snack ou modulaire cuisines sans augmentation de prix. Demandez délai de livraison.



Detalle de pata con pie regulable con funda antivibratora.
Detail of adjustable feet with antivibrator cover.
Détail de pie réglable avec base anti-vibrateur.



Manufacturing characteristics:

Fully manufactured in stainless steel.
Reinforced and soundproofed worktop 1.5 mm thick.
Lower supporting frame under stainless steel worktop.
Frame ready to install shelves without the use of tools.
1.5 mm worktop reinforced and acoustically treated
40x40 mm tubular legs curved to avoid pipes
Adjustable feet to favor stability, since they fit in any floor unevenness.
No wood is used in the manufacture of our tables
Optionally, the following accessories can be installed:

Drawers	462
Lateral wastepaper bin	378
Knifeholder	132
Wheels	466
Polyethylene fibres	80
Waste receptacle for scraps	368
Fixed sinks	435
Knifeholder disinfectant	305
Containers	355



Detalle de rueda de acero inoxidable con freno acoplada a pata.
Detail of wheel in stainless steel with brake fixed to leg.
Détail de roue en acier inoxydable avec frein installé dans pied.



Caractéristiques de fabrication:

Fabriqué entièrement en acier inoxydable.
Plan de travail renforcé et insonorisé de 1,5 mm d'épaisseur.
Armatures inférieures de renfort sous le plan de travail d'acier inoxydable.
Armature préparée pour incorporer des étagères sans l'utilisation d'outils.
Plan renforcé et insonorisé d'1,5 mm d'épaisseur.
Empiètements en tube de 40 x 40 déplacées pour courbure sanitaire.
Empiètements réglables pour favoriser la stabilité, car ils s'adaptent à quelque dénivellement du sol.
Dans la fabrication de nos tables, nous n'employons pas de bois.
Optionnellement on peut installer les suivantes accessoires



Tiroirs et trémie pour marc de café	462
Corbeille à papier lateral	378
Porte couteaux	132
Roues	466
Fibres en polyéthylène	80
Trémie d'évacuation des déchets	368
Eviers soudés	435
Porte-couteaux désinfecteur	305
Conteneurs	355

Mesas centrales

Central tables
Tables centrales

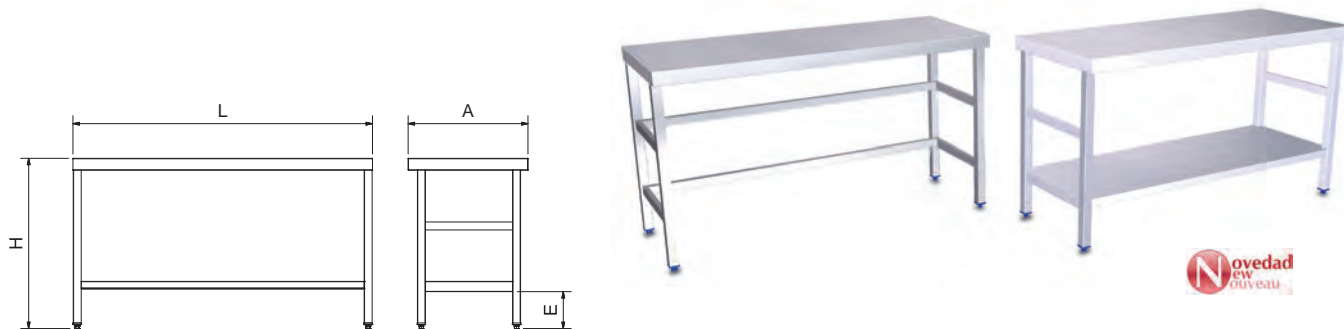

L	A	H	E	Kg	Barcode	€	Kg	Barcode	€	Kg	Barcode	€			
1.000	500	850	200	27,0	070202	503,00	23,0	070402	473,00	5,0	2702028	114,00			
1.500	500	850	200	36,0	070204	614,00	29,0	070404	578,00	9,0	2702048	131,00			
2.000	500	850	200	47,0	070206	663,00	36,0	070406	623,00	13,0	2702068	148,00			
1.000	600	850	200	29,0	070208	562,00	25,0	070408	528,00	6,0	2702088	131,00			
1.500	600	850	200	38,0	070210	625,00	32,0	070410	587,00	10,0	2702108	148,00			
2.000	600	850	200	52,0	070212	696,00	40,0	070412	655,00	15,0	2702128	165,00			
1.000	700	850	200	33,0	070214	611,00	29,0	070414	574,00	8,0	2702148	148,00			
1.500	700	850	200	43,0	070216	675,00	34,0	070416	634,00	13,0	2702168	165,00			
2.000	700	850	200	60,0	070218	763,00	46,0	070418	718,00	19,0	2702188	182,00			



Mesas murales

Wall-side tables
Tables murales

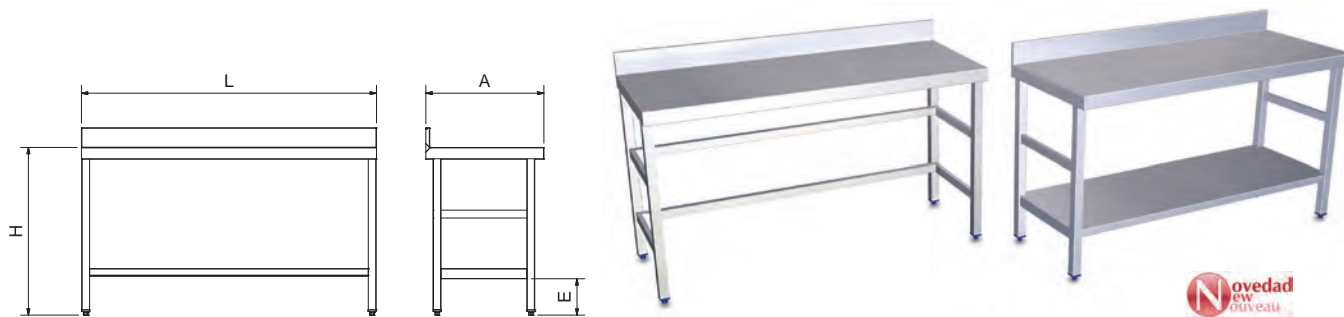

L	A	H	E	Kg	Barcode	€	Kg	Barcode	€	Kg	Barcode	€			
1.000	500	850	200	24,0	070602	506,00	21,0	070802	475,00	5,0	2702028	114,00			
1.500	500	850	200	35,0	070604	618,00	29,0	070804	581,00	9,0	2702048	131,00			
2.000	500	850	200	47,0	070606	666,00	37,0	070806	626,00	13,0	2702068	148,00			
1.000	600	850	200	27,0	070608	565,00	23,0	070808	531,00	6,0	2702088	131,00			
1.500	600	850	200	38,0	070610	628,00	32,0	070810	590,00	10,0	2702108	148,00			
2.000	600	850	200	52,0	070612	700,00	40,0	070812	659,00	15,0	2702128	165,00			
1.000	700	850	200	31,0	070614	615,00	26,0	070814	578,00	8,0	2702148	148,00			
1.500	700	850	200	45,0	070616	679,00	37,0	070816	638,00	13,0	2702168	165,00			
2.000	700	850	200	61,0	070618	767,00	46,0	070818	722,00	19,0	2702188	182,00			



Mesas murales con puertas

Wall-side tables with doors
Tables murales avec portes



Características:

Laterales y trasera forrados en acero inoxidable. Entrepañó inferior a 200 mm del suelo y el otro centrado.

La principal ventaja de nuestras mesas de puertas correderas consiste en que las puertas van colgadas, lo que evita depósitos de suciedad en carriles y entrepaños. Tiradores integrados en la puerta.

Characteristics:

Sides and back covered with stainless steel panels. Centered shelf.

The main advantage of our sliding doors tables consists in their hanging doors. They avoid dirtiness deposits in rails and shelves. Furthermore the handles are integrated in the door.

Caractéristiques:

Latérales et fond recouvertes en acier inoxydable. Tablette-rayon centré.

La principale avantage de nos tables à portes coulissantes c'est que ses portes sont suspendues pour éviter des dépôts de saleté dans les rails et dans les tablettes-rayons. En plus les poignées sont intégrées dans la porte.

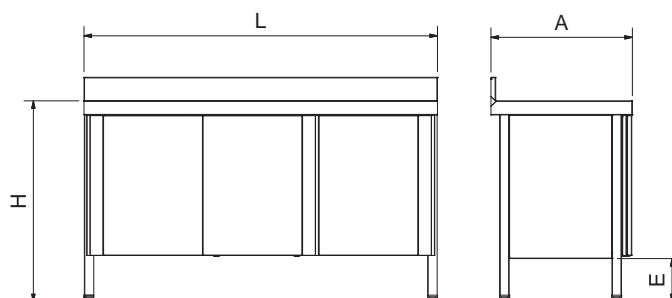
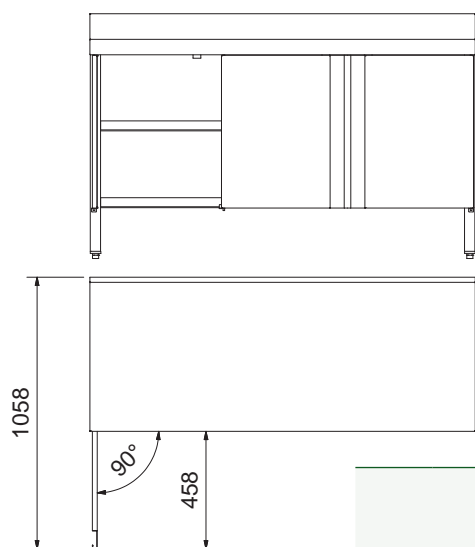

				Correderas Sliding doors Coulissantes				Abatibles Hinged doors Deux battants			
L	A	H	E	Kg	Barcode	Qty	€	Kg	Barcode	Qty	€
1.000	400	850	200	28,0	073803	2	900,00				
1.000	500	850	200	40,0	073802	2	875,00	42	074002	2	893,00
1.500	500	850	200	56,0	073804	3	1.083,00	59	074004	3	1.105,00
2.000	500	850	200	67,0	073806	4	1.276,00	71	074006	4	1.302,00
1.000	600	850	200	43,0	073808	2	1.041,00	45	074008	2	1.063,00
1.500	600	850	200	58,0	073810	3	1.233,00	61	074010	3	1.258,00
2.000	600	850	200	77,0	073812	4	1.424,00	81	074012	4	1.453,00
1.000	700	850	200	48,0	073814	2	1.125,00	50	074014	2	1.148,00
1.500	700	850	200	64,0	073816	3	1.324,00	67	074016	3	1.352,00
2.000	700	850	200	84,0	073818	4	1.521,00	88	074018	4	1.552,00

Mesas murales a pared

Wall-fitted tables
Tables à fixer au mur

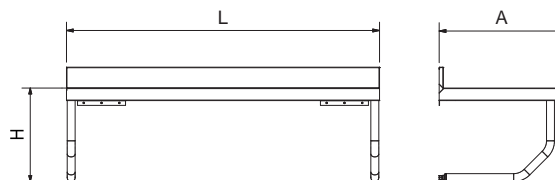

L	A	H	Kg	Barcode	€
1.000	500	450	17	071002	494,00
1.500	500	450	22	071004	604,00
1.000	600	450	23	071006	524,00
1.500	600	450	28	071008	651,00
1.000	700	450	26	071010	588,00
1.500	700	450	34	071012	714,00

Mesas murales con puertas y cajones

Wall-side tables with doors and drawers
Tables murales avec portes et tiroirs

Características:

Fabricada totalmente (interior y exterior) en acero inoxidable AISI 304.

Encimera de 1,5 mm de espesor, reforzada e insonorizada. Dos o tres puertas de corredera suspendidas, sin carriles inferiores donde se pueda depositar la suciedad.

Laterales forrados.

Doble entrepaño, trasera y lateral interior en la zona del armario.

Cuatro cajones con cerradura. Dimensiones interiores de los cajones: 460x440x140 mm

Patas traseras retranqueadas para adaptarse a las curvas sanitarias del suelo con pared.

Pies regulables norma alimentaria.

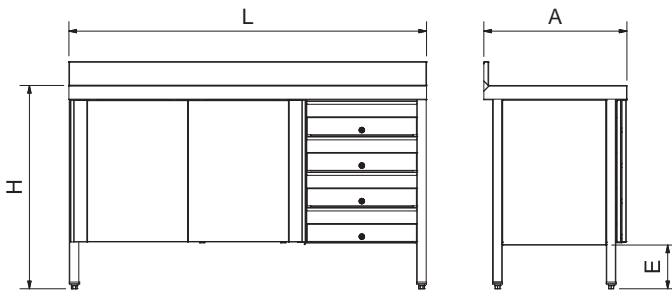

L	A	H	E		Kg		€
1.500	500	850	180	2	71	074474	1.757,00
1.500	600	850	180	2	73	074452	1.807,00
1.500	700	850	180	2	79	074456	2.178,00
2.000	500	850	180	3	82	074476	1.943,00
2.000	600	850	180	3	92	074454	2.054,00
2.000	700	850	180	3	99	074458	2.401,00

Characteristics:

Interior and exterior fully manufactured in stainless steel AISI 304.

Reinforced and soundproofed worktop in 1.5 mm. thickness

Two or three suspended sliding doors, without bottom rails to avoid deposits of dirt.

Lined sides.

Double shelf. Closet area with rear and interior sides paneled.

Four drawers with lock. Interior dimensions of the drawers: 460x440x140 mm.

Retracted hind legs to adapt to the sanitary curves of the floor with wall.

Adjustable feet to meet the food standards.

Caractéristiques:

Entièrement fabriquée (intérieurement et extérieurement) en acier inoxydable AISI 304.

Plan de travail de 1,5 mm d'épaisseur, renforcé et insonorisé.

Deux ou trois portes coulissantes suspendues, sans rails inférieurs où la saleté peut être déposée.

Côtés doublés.

Double étagère, côté arrière et intérieur dans la zone de l'armoire

Quatre tiroirs avec serrure. Dimensions intérieures des tiroirs: 460x440x140 mm.

Patte arrière rétractée pour s'adapter aux courbes sanitaires du sol avec mur.

Pieds réglables norme alimentaire.

Mesa mural con cartelas

Wall fitted table with brackets
Table murale avec équerres

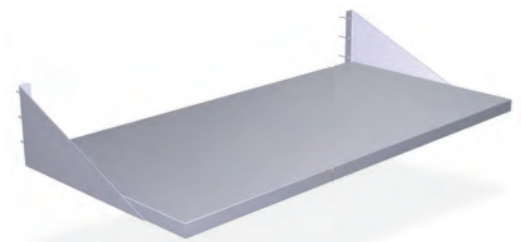

Cajonera para mesa mural con cartelas (400 mm.)
Drawer box for wall-fitted table with brackets
Tiroirs pour table murale avec équerres

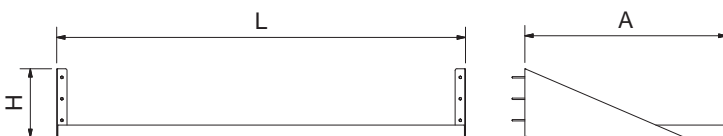

L	A	H	Kg		€
800	600	200	6	071050	102,00
1.000	600	200	7	071052	107,00
1.200	600	200	8	071054	113,00
1.400	600	200	9	071056	118,00

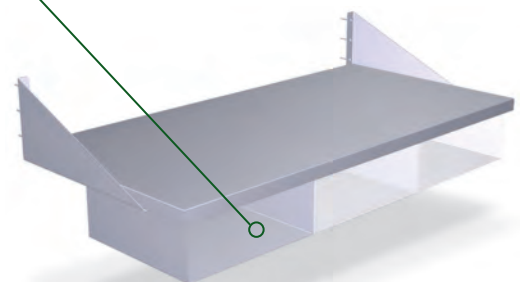

Mesas murales de Chef

Chef wall-side table
Table murale de chef

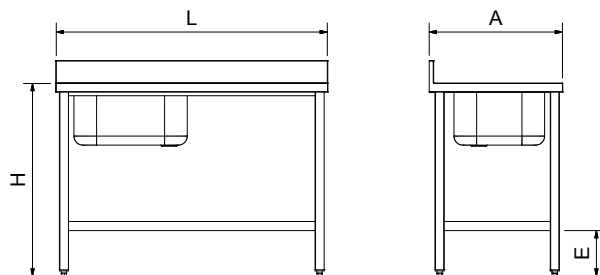
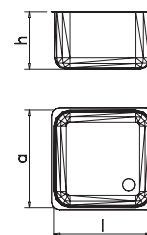
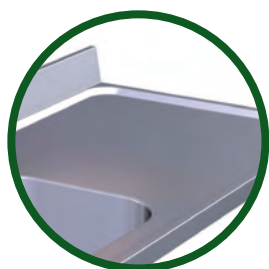

								Con entrepaño With shelf Avec tablette-rayon			Sin entrepaño Without shelf Sans tablette-rayon		
	L	A	H	E	I	a	h	Kg	Barcode	€	Kg	Barcode	€
	1.200	600	850	200	500	400	250	27	075202	747,00	24	075402	656,00
	1.200	700	850	200	500	500	300	29	075206	827,00	26	075406	729,00
	1.200	600	850	200	500	400	250	27	075204	747,00	24	075404	656,00
	1.200	700	850	200	500	500	300	29	075208	827,00	26	075408	729,00

Mesa mural desbarasado con fregadero

Wall-side table for waste chutes with sink
Table murale vide déchets avec bac

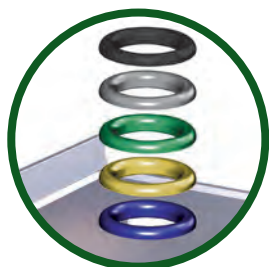
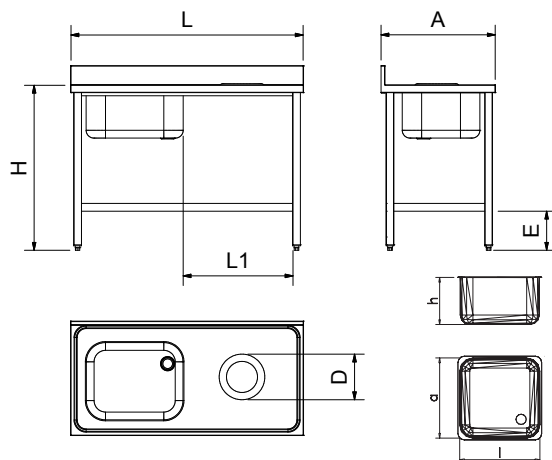

	L	A	H	E	I	a	h	L1	D	Kg	Barcode	€
	1.200	600	850	200	500	400	250	570	200	24,5	MD-60-I	781,00
	1.200	700	850	200	500	500	300	570	200	26,5	MD-70-I	854,00
	1.200	600	850	200	500	400	250	570	200	24,5	MD-60-D	781,00
	1.200	700	850	200	500	500	300	570	200	26,5	MD-70-D	854,00

Mesa mural desbarasado con puerta

Waste chutes wall-side table
Table murale pour trémie à déchets

Características:

Laterales y trasera forrados en acero inoxidable.
Aro para tolva de desbarasado color azul.
Tapa para aro.

Characteristics:

Sides and back covered with stainless steel panels.
Blue ring for waste chutes.
Ring lid.

Caractéristiques:

Latérales et fond recouvertes en acier inoxydable.
Cercle bleu pour trémies à déchets.
Couvercle.

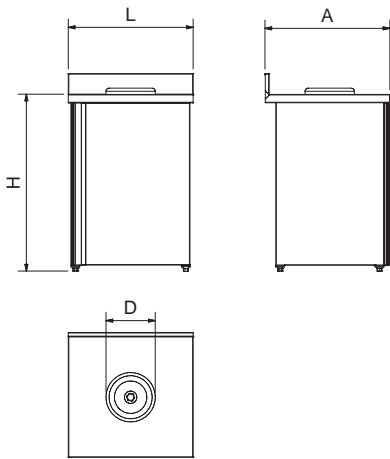
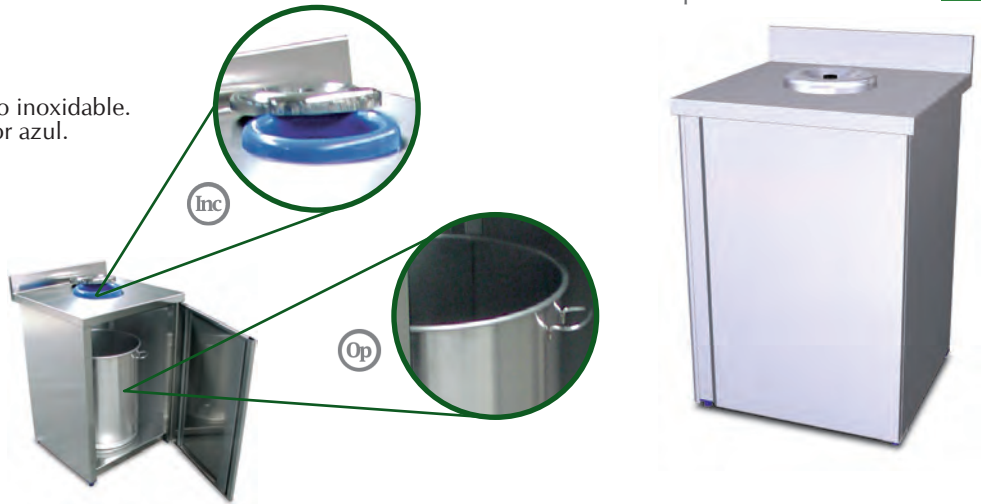

Inc Incluido / Included / Inclus
Op Opcional / Optional / Optionnel



L	A	H	D	Kg	Barcode	€
600	600	850	235	23	074438	630,00
600	700	850	235	28	074437	790,00



Ejemplo de zona de lavado. Posibilidad de diferentes combinaciones al poder colocar la mesa a uno u otro lado.
Example of rinse zone. Possibility of different combinations with the table on one side or the other.
Exemple de zone de lavage. Possibilité de diverses combinaisons avec la table d'un côté ou de l'autre.

Mesa de preparación de verduras

Vegetable preparation table
Table de préparation de légumes

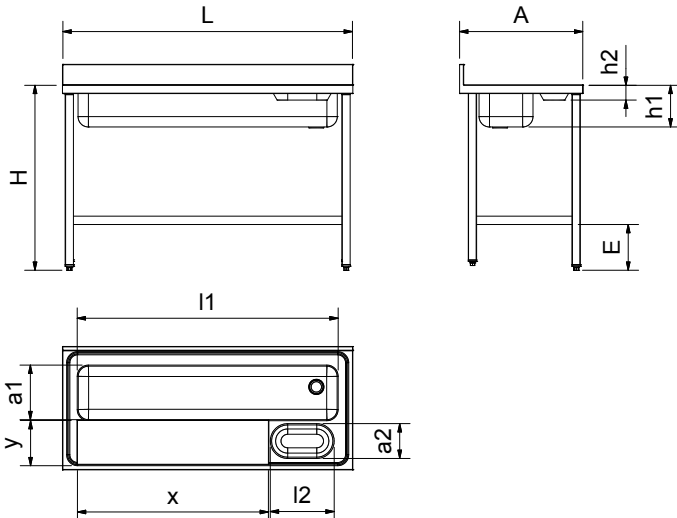

L	A	H	E	I1	a1	h1	I2	a2	h2	X	y	Kg	Barcode	€
1.400	600	850	200	1.250	260	180	300	160	50	925	215	28	075602	998,00

Mesas de preparación y lavado

Preparation and cleansing tables
Tables de préparation et de lavage



Novedad
New
nouveau

Dotación y características de fabricación:

Totamente construida con acero inoxidable.
Fibra de polietileno calidad P-500.
Fregadero soldado con válvula, tapón y rebosadero.
Tolva de evacuación de desperdicios.

Features and manufacturing characteristics:

Made totally from stainless steel.
P-500 quality polyethylene fibre.
Welded bowl with valve, plug and overflow.
Hole for waste-chutes

Dotation et caractéristiques de fabrication:

Entièrement fabriquées en acier inoxydable.
Fibre de polyéthylène qualité P-500.
Bac soudée avec valve, déversoir.
Trou pour tremie à déchets.



Repuestos de fibras.
Spare fibres.
Fibres de rechange.



82

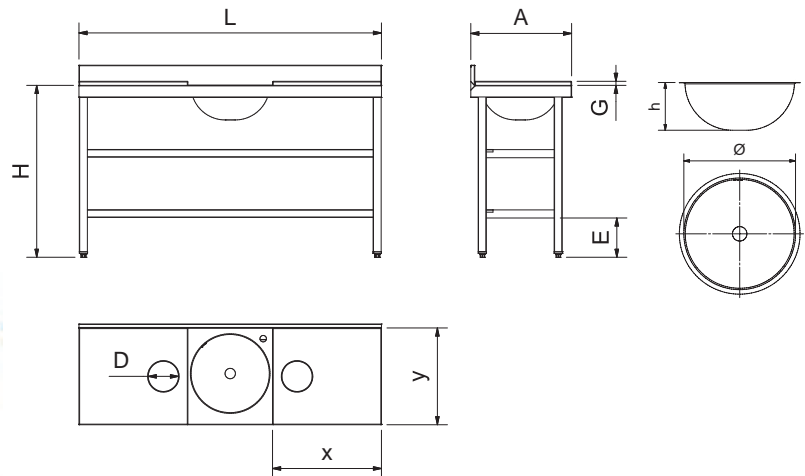

Op Opcional / Optional / Optionnel

	L	A	H	E	Ø	h	X	y	G	D	Kg	€	
	1.000	500	850	200	390	170	540	480	20	150	23,5	072802 072880 072852	756,00
	1.000	500	850	200	390	170	540	480	20	150	23,5	072810 072882 072860	756,00
	1.500	500	850	200	390	170	540	480	20	150	30,0	072812 072884 072862	935,00
	1.500	500	850	200	390	170	540	480	20	150	30,0	072820 072886 072870	935,00
	1.500	500	850	200	390	170	540	480	20	150	34,0	072822 072888 072872	1.059,00

Mesa mural de prelavado
Pre-rinse wall-side table
Table mural de pré-lavage

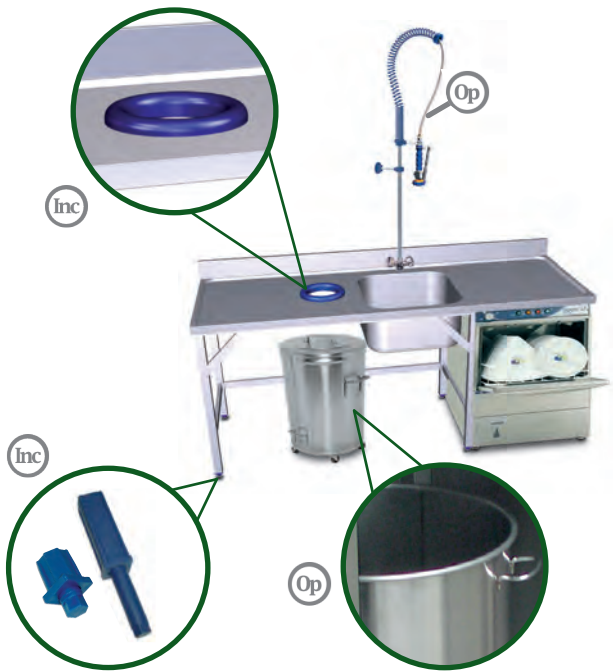

Dotación y características de fabricación:
Totalmente construida en acero inoxidable, provista de reborde perimetral salva-aguas. Esta mesa está diseñada para albergar un lavavajillas y un contenedor de residuos bajo ella. Además hay espacio útil para depositar las cestas en la encimera antes del desbarasado. Dotada de fregadero soldado con válvula, tapón, rebosadero y tolva de evacuación de desperdicios.

Equipment and manufacturing characteristics:
Worktop made in stainless steel. Manufactured with perimeter raised edge to avoid water pouring. This table has been designed to lodge a dishwasher and a waste bin below. In addition there is spare room enough to deposit basket in the worktop before the waste of scraps. Provided with welded sink with valve, plug and overflow and ring for waste chutes.

Équipement et caractéristiques de fabrication:
Dessus construit en acier inoxydable. Fabriqué avec rebord dans le périmètre pour éviter des reversement d'eau. Cette table a été dessinée pour allouer un lave-vaisselles et un conteneur de déchets dessous. En plus, il y a espace libre pour déposer des paniers dans le dessus avant l'évacuation des déchets. Pourvu avec plonge soudé avec valve, bouchon et déversoir et trémie d'évacuation de déchets.

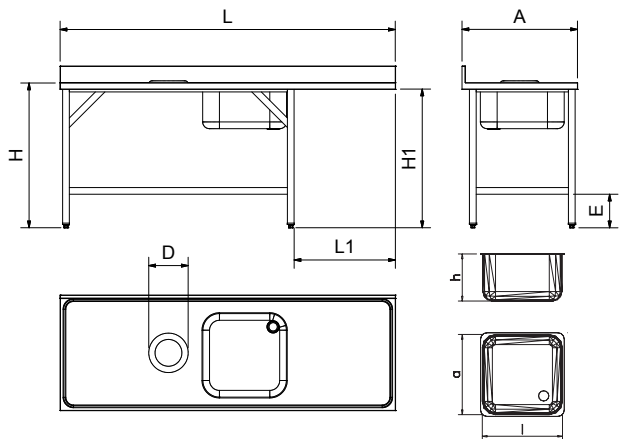

	L	A	H	I	a	h	L1	H1	D	E	Kg	Barcode	€
	2.000	700	850	500	500	300	610	890	235	200	40	074435	1.265,00
	2.000	700	850	500	500	300	610	890	235	200	40	074436	1.265,00

Características:
Provistas de cajones con rodamientos totalmente contruidos en acero inoxidable. Laterales forrados en zona de cajones.

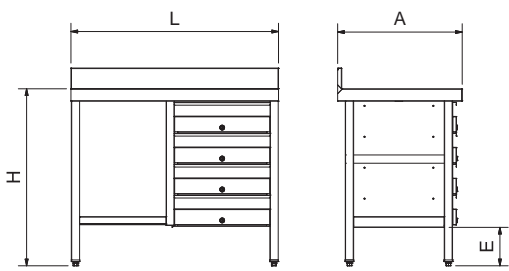

Characteristics:
Supplied with drawers, with all bearings made from stainless steel. The sides lined in the drawers zone.

Caractéristiques:
Munies de tiroirs avec roulements entièrement fabriqués en acier inoxydable. Côtés recouverts au niveau des tiroirs.

Mesas murales de cajones
Wall-side tables with drawers
Tables murales à tiroirs



	L	A	H	E	Kg	Barcode	€
	1.000	500	850	200	44	074202	1.336,00
	1.000	600	850	200	48	074204	1.381,00
	1.000	700	850	200	54	074206	1.435,00

Mesas plegables con entrepaño

Centre table with shelve
Table centrale avec rayon



Video



Características:

Fácil transporte.
Fácil almacenaje.
Patas escamoteables hasta alcanzar 1.200x600x63 mm.
Totalmente en acero inoxidable.

Characteristics:

Easy to move.
Easy to store.
Retractable legs to 1200x600x63 mm.
Wholly made of stainless steel.

Caractéristiques:

Facile à déplacer.
Facile à ranger.
Pieds rétractables à 1200x600x63 mm.
Entièrement réalisé en acier inoxydable.

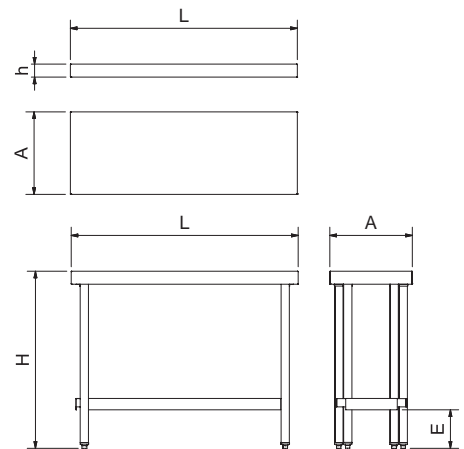

L	A	H	E	h	Kg	Barcode	€
1.100	400	860	187	63	16,0	075804	421,00
1.300	400	860	187	63	18,0	075806	439,00
1.100	500	860	187	63	17,0	075808	450,00
1.300	500	860	187	63	19,0	075810	469,00

Mesa mural sotabanco con dos entrepaños

Console table with two shelves
Table console avec deux tablettes-rayons

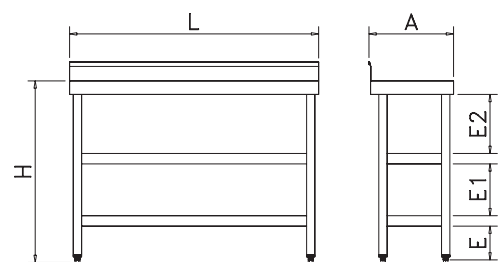

L	A	H	E	E1	E2	Kg	Barcode	€
1.000	400	850	200	243	243	15,95	074408	431,00
1.200	400	850	200	243	243	19,95	074410	456,00

Mesa central con dos entrepaños. Especial cortadoras de fiambre

Centre table with two shelves. Specially for cutting machines
Table centrale avec deux rayons. Special pour machines à couper

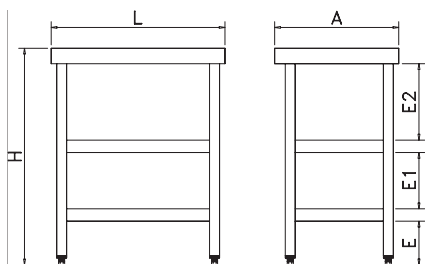

L	A	H	E	E1	E2	Kg	Barcode	€
705	505	855	150	270	270	18	074402	370,00

Soporte sobre-mostrador para cortadoras de fiambre

Stand support for cold meat cutting
Support sur comptoir pour coupe-charcuterie

Características:

Altura regulable.

Las guías inferiores son regulables para la adaptación al ancho de la tapa del evaporador de cualquier vitrina.

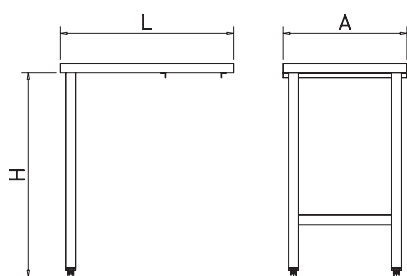

Characteristics:

Adjustable height.

The lower rails are adjustable to adapt the width of the evaporator cover to any display.

Caractéristiques:

Hauteur réglable.

Les rails inférieurs sont réglables pour l'adaptation du largeur du couvercle de l'évaporateur à quelque comptoir.



L	A	H	Kg	Barcode	€
690	490	802-882	8,15	082204	285,00

Mesa central con entrepaño. Especial maquinaria

Centre table with shelf. Specially for machines
Table centrale avec rayon. Special pour machinerie

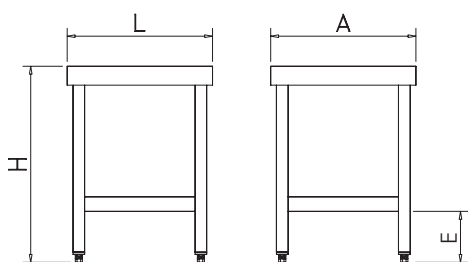

L	A	H	E	Kg	Barcode	€
505	505	655	150	15	074422	274,00

Mesa de terraza

Terrace working table
Table Terrasse



Diseñada para su uso en terrazas y exteriores, esta mesa será de gran utilidad.
Fabricada en acero inoxidable AISI 304, incorpora dos cajones sencillos y uno doble, todos ellos con cerradura.
Cuenta con una puerta abatible y un estante intermedio en el habitáculo interior.
Dispone de cuatro ruedas giratorias de estructura galvanizada y banda de rodadura de goma anti-sonora, dos de ellas con freno.

Opcionalmente se le pueden instalar:
Estanterías de sobremesa.
Portanotas mural.
Adaptador de cestillos cuberteros.
Adaptador de contenedor desperdicios.
Adaptador de cubetas gastronorm.
Kit de utensilios, válido también para manteles de papel.
Tolva para evacuación de desperdicios en el lateral de la zona de la puerta.

081802 € 25 431 Op

Porta-notas mural
Wall mounted note-holder
Porte-notes mural

486024 € 18 373 Op

Contenedor de desperdicios y reciclaje
Waste and recycling container
Conteneur à ordures et recyclage

076060 € 300 301 Op
276060

Estanterías de sobremesa
Desktop shelves
Étagères à poser sur table

020102 € 40 52 Op

Kit para colgar utensilios
Tool-holder kit
Kit pour suspendre outils



Specially designed for outdoor and terrace use. This table will be very useful.
Made of stainless steel AISI 304. It is provided with two single drawers and a double one, all of them with lock.
Cabinet with hinged door and intermediate shelf.
It has four rotating wheels, two of them with brake, with structure in galvanized steel and anti-noise rolling profile in rubber.

Optionally, the following accessories can be installed:
Tabletop shelves.
Wall mounted note-holder.
Adaptor for cutlery basket.
Adaptor for waste container.
Adaptor for Gastronorm container.
Tool-holder kit, also suitable for disposable tablecloths.
Waste receptacle for scraps, on the side of the cabinet.

Conçue pour un usage en terrasse et en extérieur, cette table vous sera d'une grande utilité.
Fabriquée en acier inoxydable AISI 304, avec deux tiroirs simples et un double, tous avec serrure.
Dispose d'une porte rabattable et une étagère intermédiaire dans l'habitacle intérieur.
Dispose de quatre roulettes tournantes de structure galvanisée et bande de roulement anti-sonore, deux d'elles avec frein.

Optionnellement on peut lui installer:
Des étagères à poser.
Porte-notes mural.
Adaptateur de panier à couverts.
Adaptateur de container de déchets.
Adaptateur de bac gastronorm.
Kit d'ustensiles, valide aussi pour des nappes en papier.
Trémie d'évacuation des déchets sur le côté dans la zone de la porte.

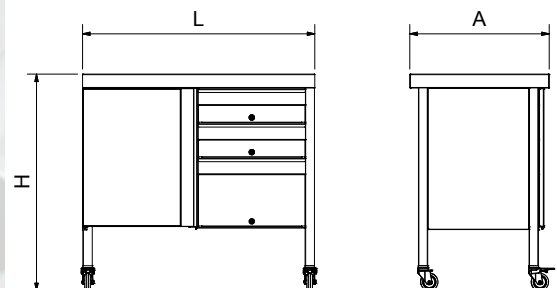

L	A	H	E	Kg	Barcode	€
1.000	600	930	270	55,0	075240	1.325,00

Mesa barman
Barman table
Barman tableau

Equipment included:

- 4 Containers GN 1/9 100 mm
- 3 Containers GN 1/2 200 mm
- 1 Black cutting board 200x250x15 mm
- 1 Waste chutes hole.
- 1 One handle elbow functioning tap, extending shower. Code 463206
- 1 Sink Ø 260x115 mm
- 1 Shelf
- 4 Plastic adjustable feet with thread inside.

Dotación de serie:

- 4 Cubetas GN 1/9 de 100 mm
- 3 Cubetas GN 1/2 de 200 mm
- 1 Fibra negra de 200x250x15 mm
- 1 Agujero evacuación de desperdicios.
- 1 Grifo monomando extensible cod. 463206
- 1 Cubeta fregadero Ø260x115 mm
- 1 Entrepañó.
- 4 Tacos regulables rosca sanitaria.

Équipement inclus:

- 4 Bacs GN 1/9 100 mm
- 3 Bacs GN 1/2 200 mm
- 1 Plaque de découpe noire 200x250x15 mm
- 1 Trou à déchets.
- 1 Robinet monocommande à coude, douche extensible. Cod 463206
- 1 Évier Ø 260x115 mm
- 1 Tablette-rayon.
- 4 Taquets réglables avec filet intérieur.



Novedad
New
nouveau



083060 65,00 432

Botellero
Wine rack
Porte-bouteilles

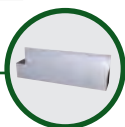

461430 14 195

Bidón de 10 lts
10 litres water drum
Bidon d'eau de 10 litres



486024 18 373

Contenedor de desperdicios y reciclaje
Waste and recycling container
Conteneur à ordures et recyclage



466

Ruedas
Wheels
Rouelles

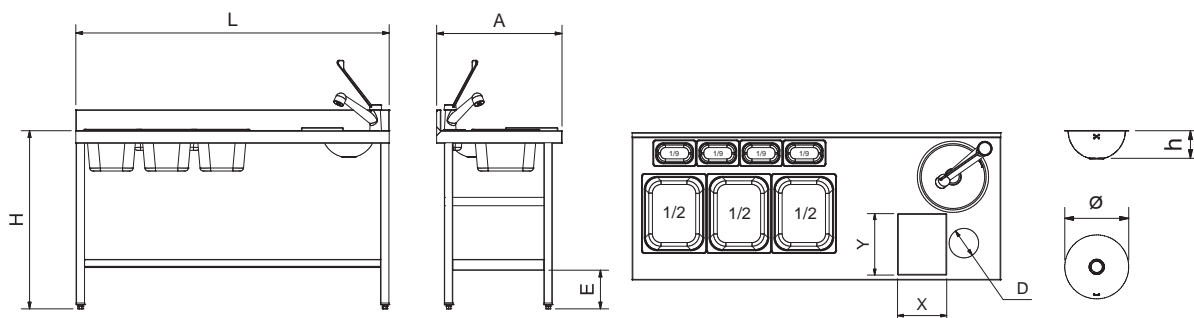

L A H E D X Y h Ø Kg 075250 1.169,00

Incluido / Included / Inclus
Opcional / Optional / Optionnel

Isla de cocina inox con encimera de madera

Kitchen island with wooden worktop
Île de cuisine inox avec plan de travail en bois



Novedad
ew
ouveau

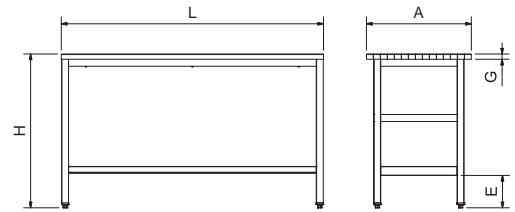

L	A	H	E	G	Kg	Barcode	€
1.000	600	880	200	30	33,0	076808	628,00
1.500	600	880	200	30	45,5	076810	769,00

Isla de cocina inox con encimera de granito

Kitchen island with granite worktop
Île de cuisine inox avec plan de travail en granit



Novedad
ew
ouveau

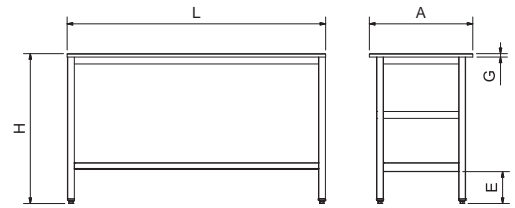

L	A	H	E	G	Kg	Barcode	€
1.000	600	870	200	20	49,0	076858	572,00
1.500	600	870	200	20	70,0	076860	700,00

Mesa central inox con encimera de cristal translúcido

Inox center table with translucent glass worktop
Table centrale inox avec plan de travail en verre



Novedad
ew
ouveau

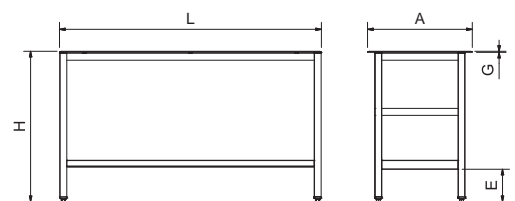

L	A	H	E	G	Kg	Barcode	€
1.000	600	860	200	6	25,9	076878	611,00
1.500	600	860	200	6	29,8	076880	761,00

Punto de venta portátil de jamones

Mobile sale point of hams
Point de vente de jambon portable

Características de fabricación:

Ruedas de $\varnothing 75$ mm.
2 cajones pequeños
1 cajón grande
2 puertas abatibles
1 contenedor verde 486026
1 Portacuchillos con envoltivo
1 Dispensador de 1 caja de guantes
1 Dispensador de papel y bolsas triple
1 Kit portarrollos
1 Pletina de 1500 mm. con 12 ganchos para jamones
1 base de jamonero giratorio basculante RT-3D
3 jamoneros giratorios RT-2D
1 fibra negra de 500x465x20 mm. con agujero de desbarasado
Espacio disponible para báscula



Novedad
New
ouveau



Manufacturing characteristics:

Wheels $\varnothing 75$ mm.
2 small drawers
1 large drawer
2 folding doors
1 green container 486026
1 Knife holder with casing
1 Dispenser for 1 glove box
1 Triple dispenser for paper and bags
1 Roll holder kit
1 1.500 mm bar with 12 hooks for hams
1 foot of tilting rotating ham holder RT-3D
3 rotary ham holders RT-2D
1 black board of 500x465x20 mm with hole for disposals
Enough room for a scale

Caractéristiques de fabrication:

Roues $\varnothing 75$ mm.
2 petits tiroirs
1 grand tiroir
2 portes ouvrantes
1 container vert 486026
1 Porte-couteau avec enveloppant
1 Distributeur de 1 boîte à gants
1 Distributeur triple papier et sac
1 Kit de support de rouleau
1 Plaque de 1500 mm. avec 12 crochets pour les jambons
1 base de porte-jambon rotatif basculant RT-3D
3 porte-jambons rotatifs RT-2D
1 plaque noire de 500x465x20 mm. avec trou pour déchets
Espace disponible pour la balance.

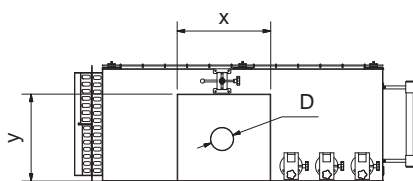
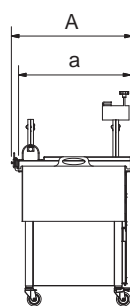
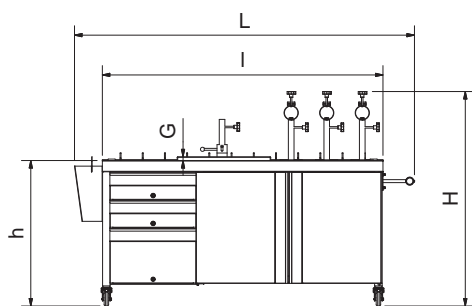

L	I	A	a	H	h	X	Y	G	D	Kg	€
1.815	1.500	645	600	1150	780	500	465	20	120	98,00	2.970,00

Estante abatible de fibra para punto de venta portátil de jamones

Polyethylene hinged shelf for mobile sale point of hams
Étagère ouvrante en fibre pour point de vente de jambon portable

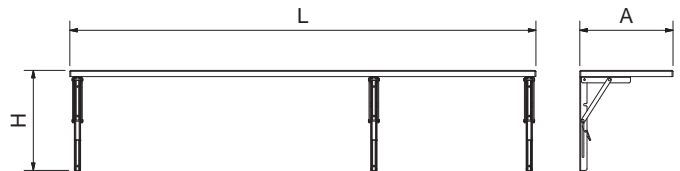

L	A	H	Kg	Barcode	€
1.500	300	325	10,3	075232	274,00

Mesa jamonera RT-2D

Ham table RT-2D
Table porte-jambon RT-2D

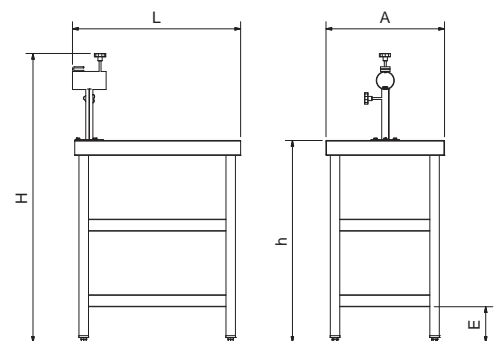

L	A	H	h	E	D	Kg	Barcode	€
710	500	1.220	850	150	60	20,00	074486	532,00

Mesa jamonera RT-3D
Ham table RT-3D
Table porte-jambon RT-3D



L	A	H	h	E	D	Kg	Barcode	€
710	500	1.220	850	150	60	20,00	074487	599,00

Accesorios para mesas jamoneras
Accessories for ham tables
Accessoires pour tables porte-jambon

Kit para colgar utensilios
Tool-holder kit
Kit pour suspendre outils

074488 58 € Op

Ruedas acopladas
Wheels
Rouelles

485002 467

Kits de portarrollos de papel o film serie Eco
Eco serie paper or film roll holder kit
Kit de porte-rouleaux du papier ou film serie Eco

074490 150 € Op

Cajón o tolva acoplado
Drawer or hopper coupled
Tiroir ou trémie accouplé

085480 464

Mesas centrales encimera de polietileno

Centre tables with polyethylene worktop
Tables centrales dessus en polyéthylène

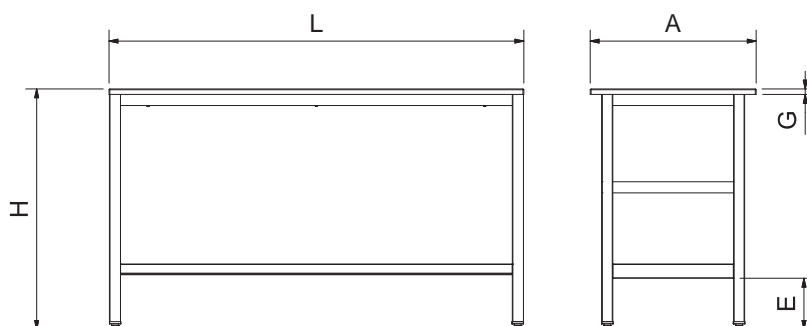

L	A	H	G	E	Kg	€	Kg	€	Kg	€			
1.000	500	870	20	200	22	071202 071252	394,00	19	071402 071452	359,00	5	2702028	114,00
1.500	500	870	20	200	34	071204 071254	568,00	28	071404 071454	516,00	9	2702048	131,00
2.000	500	870	20	200	46	071206 071256	682,00	35	071406 071456	620,00	14	2702068	148,00
1.000	600	870	20	200	25	071208 071258	487,00	21	071408 071458	442,00	6	2702088	131,00
1.500	600	870	20	200	37	071210 071260	579,00	30	071410 071460	526,00	10	2702108	148,00
2.000	600	870	20	200	53	071212 071262	720,00	41	071412 071462	655,00	15	2702128	165,00
1.000	700	870	20	200	28	071214 071264	489,00	22	071414 071464	445,00	8	2702148	148,00
1.500	700	870	20	200	42	071216 071266	622,00	33	071416 071466	565,00	13	2702168	165,00
2.000	700	870	20	200	57	071218 071268	763,00	44	071418 071468	694,00	19	2702188	182,00



Repuestos de fibras.
Spare fibres.
Fibres de rechange.

Mesas de preparación centrales

Centre preparation tables
Tables de préparation centrales

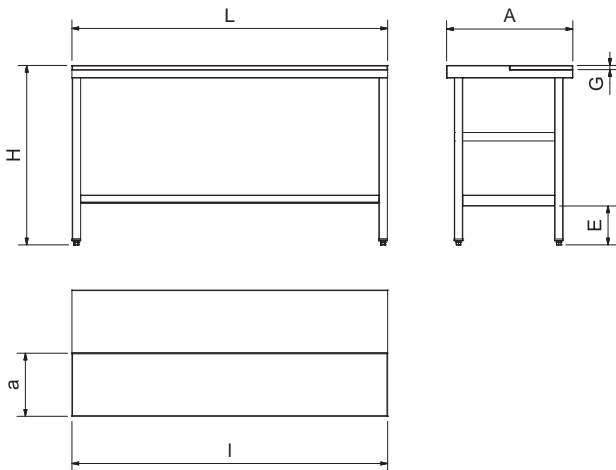

L	A	H	I	a	G	E	Kg		€	Kg		€	Kg		€
1.000	600	850	1.000	300	20	200	37		902,00	32		824,00	6	2702088	131,00
								071602 071652			071802 071852				
1.500	600	850	1.500	300	20	200	50		1.028,00	44		933,00	10	2702108	148,00
								071604 071654			071804 071854				
2.000	600	850	2.000	300	20	200	66		1.156,00	54		940,00	15	2702128	165,00
								071606 071656			071806 071856				
1.000	700	850	1.000	300	20	200	42		971,00	37		893,00	8	2702148	148,00
								071608 071658			071808 071858				
1.500	700	850	1.500	300	20	200	56		1.116,00	47		1.010,00	13	2702168	165,00
								071610 071660			071810 071860				
2.000	700	850	2.000	300	20	200	75		1.245,00	61		1.118,00	19	2702188	182,00
								071612 071662			071812 071862				
1.000	800	850	1.000	300	20	200	47		1.045,00	39		940,00	10	2702208	169,00
								071614 071664			071814 071864				
1.500	800	850	1.500	300	20	200	62		1.187,00	51		1.068,00	14	2702228	185,00
								071616 071666			071816 071866				
2.000	800	850	2.000	300	20	200	82		1.332,00	66		1.197,00	21	2702248	203,00
								071618 071668			071818 071868				



Repuestos de fibras.
Spare fibres.
Fibres de rechange.

82









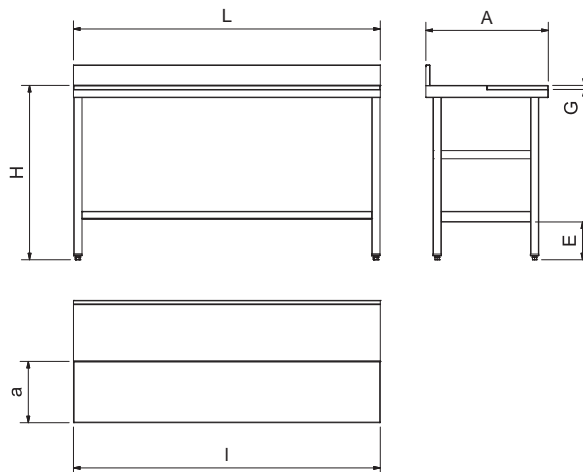























Mesas de preparación murales

Wall-side preparation tables
Tables de préparation murales



Novedad
ouveau



																						
L	A	H	l	a	G	E	Kg		€	Kg		€	Kg		€							
1.000	600	850	1.000	300	20	200	37		890,00	33		819,00	6		131,00							
								072052			072252			2702088								
1.500	600	850	1.500	300	20	200	49		1.013,00	42		926,00	10		148,00							
								072054			072254			2702108								
2.000	600	850	2.000	300	20	200	64		1.136,00	52		1.042,00	15		165,00							
								072056			072256			2702128								
1.000	700	850	1.000	300	20	200	39		958,00	34		888,00	8		148,00							
								072058			072258			2702148								
1.500	700	850	1.500	300	20	200	54		1.099,00	46		994,00	12		165,00							
								072060			072260			2702168								
2.000	700	850	2.000	300	20	200	73		1.224,00	59		1.109,00	18		182,00							
								072062			072262			2702188								
1.000	800	850	1.000	300	20	200	44		1.024,00	36		937,00	10		169,00							
								072064			072264			2702208								
1.500	800	850	1.500	300	20	200	60		1.167,00	50		1.061,00	14		185,00							
								072066			072266			2702228								
2.000	800	850	2.000	300	20	200	78		1.319,00	62		1.195,00	21		203,00							
								072068			072268			2702248								



Repuestos de fibras.
Spare fibres.
Fibres de rechange.

Mesas centrales con reborde y desagüe

Centre tables with raised edge and drain
Tables centrales avec rebord et trou d'écoulement

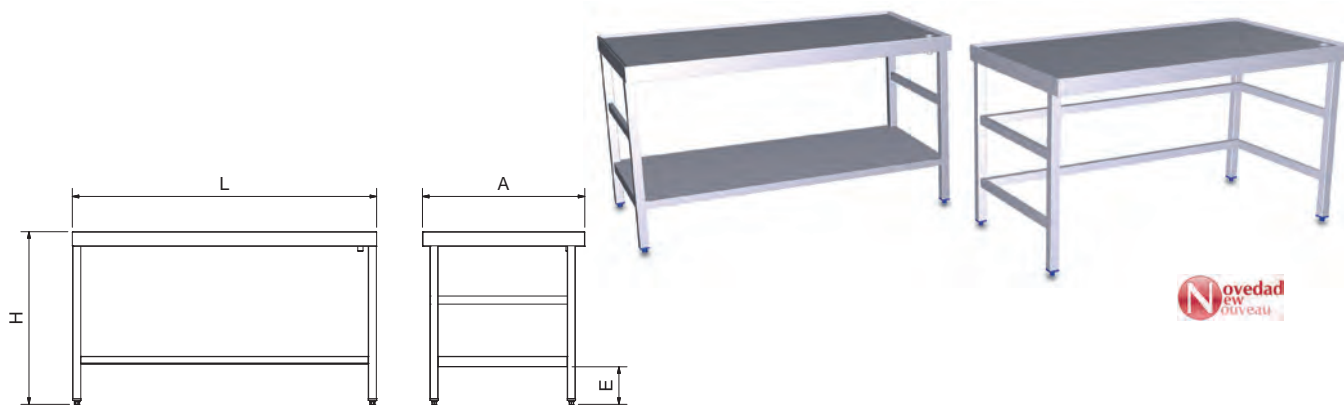

L	A	H	E	Kg	Barcode	€	Kg	Barcode	€	Kg	Barcode	€
1.000	600	850	200	46	073020	1.140,00	38	073220	1.017,00	11	2702088	131,00
1.500	600	850	200	54	073022	1.262,00	42	073222	1.122,00	15	2702108	148,00
2.000	600	850	200	76	073024	1.365,00	55	073224	1.191,00	25	2702128	165,00
1.000	700	850	200	49	073026	1.235,00	40	073226	1.089,00	12	2702148	148,00
1.500	700	850	200	58	073028	1.363,00	45	073228	1.203,00	16	2702168	165,00
2.000	700	850	200	81	073030	1.486,00	56	073230	1.297,00	26	2702188	182,00
1.000	800	850	200	38	073002	1.285,00	30	073202	1.135,00	10	2702208	169,00
1.500	800	850	200	51	073004	1.414,00	40	073204	1.239,00	14	2702228	185,00
2.000	800	850	200	67	073006	1.557,00	50	073206	1.355,00	21	2702248	203,00

Mesas murales con reborde y desagüe

Wall-side tables with raised edge and drain
Tables murales avec rebord et trou d'écoulement

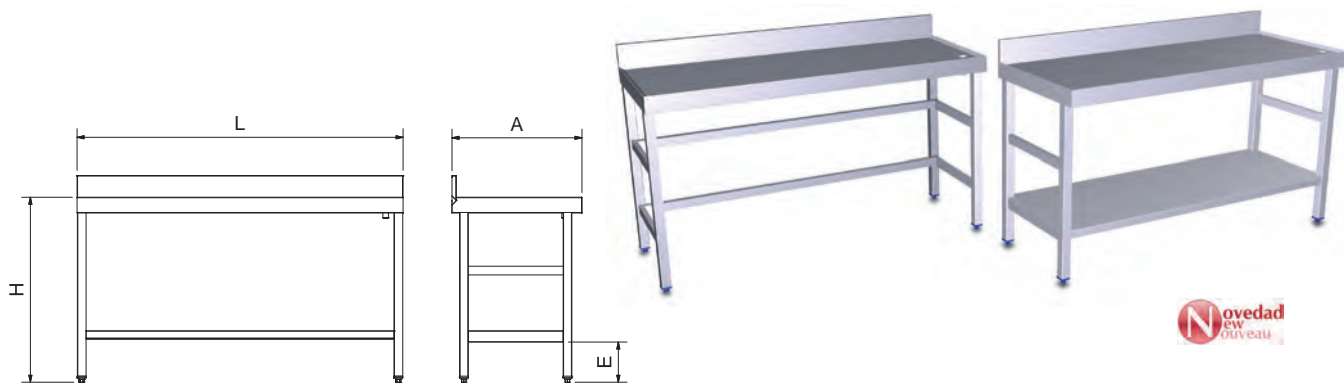

L	A	H	E	Kg	Barcode	€	Kg	Barcode	€	Kg	Barcode	€
1.000	600	850	200	30	073402	1.140,00	25	073602	1.017,00	6	2702088	131,00
1.500	600	850	200	39	073404	1.262,00	32	073604	1.122,00	10	2702108	148,00
2.000	600	850	200	51	073406	1.365,00	42	073606	1.191,00	15	2702128	165,00
1.000	700	850	200	33	073408	1.235,00	28	073608	1.089,00	8	2702148	148,00
1.500	700	850	200	46	073410	1.363,00	38	073610	1.203,00	12	2702168	165,00
2.000	700	850	200	60	073412	1.486,00	46	073612	1.297,00	18	2702188	182,00
1.000	800	850	200	36	073414	1.285,00	29	073614	1.135,00	10	2702208	169,00
1.500	800	850	200	49	073416	1.414,00	39	073616	1.239,00	14	2702228	185,00
2.000	800	850	200	65	073418	1.557,00	48	073618	1.355,00	21	2702248	203,00

Mesas de despiece

Quartering tables
Tables de découpage

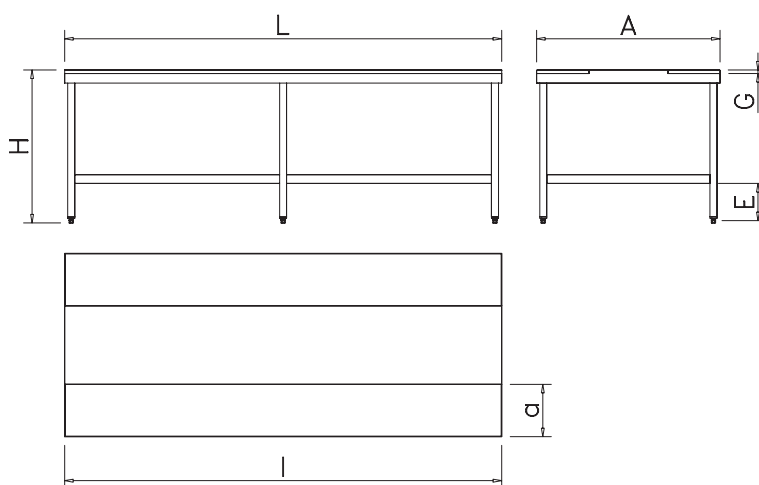

L	A	H	l	a	G	E	Kg		€	Kg		€	Kg		€						
1.500	1.050	850	1.500	400	20	200	78		1.855,00	65		1.855,00	20	270238	260,00						
								072402			072602										
								072452			072652										
2.000	1.050	850	2.000	400	20	200	105		2.180,00	86		2.180,00	27	270240	300,00						
								072404			072604										
								072454			072654										
2.500	1.050	850	2.500	400	20	200	132		2.768,00	108		2.768,00	30	270242	400,00						
								072406			072606										
								072456			072656										
3.000	1.050	850	3.000	400	20	200	158		2.999,00	128		2.999,00	39	270244	420,00						
								072408			072608										
								072458			072658										
1.500	1.300	850	1.500	400	20	200	91		2.059,00	73		2.059,00	25	270246	280,00						
								072410			072610										
								072460			072660										
2.000	1.300	850	2.000	400	20	200	125		2.370,00	97		2.370,00	32	270248	335,00						
								072412			072612										
								072462			072662										
2.500	1.300	850	2.500	400	20	200	160		2.951,00	115		2.951,00	58	270250	440,00						
								072414			072614										
								072464			072664										
3.000	1.300	850	3.000	400	20	200	185		3.219,00	132		3.219,00	62	270252	465,00						
								072416			072616										
								072466			072666										



Repuestos de fibras.
Spare fibres.
Fibres de rechange.

Contenedor inox para vaciado de bandejas de comida rápida

Stainless steel waste bin for fast-food tray's emptying

Poubelle en acier inoxydable spéciale snack restauration rapide

Características de fabricación:

Fabricado totalmente con acero inoxidable.
Sistema patentado de pedal. Permitirá al usuario abrir la trampilla sin necesidad de usar las manos. La trampilla también se puede abrir con la mano en caso de requerirlo.
Las varillas de la parte superior del mueble facilitan la colocación de las bandejas.
La tolva de caída de los desperdicios es de una sola pieza y no posee juntas ni huecos, lo que facilita la limpieza.
Asa de la puerta ergonómica.
El contenedor posee dos ruedas, lo que permite desplazarlo con poco esfuerzo.
Provisto de dos tacos regulables en altura para adaptarse a cualquier clase de suelo, evitando desplazamientos accidentales o no deseados.
Insonorizado en todas sus piezas.

Manufacturing characteristics:

Wholly made of stainless steel.
Pedal operated patented system. It will allow the user to open the lid avoiding the use of his hands. The lid can also be opened with the hand if necessary.
Rods on the top that make easier the placing of the empty trays.
Receptacle for scraps made in one only piece, without joints or hollows.
Ergonomic handle.
It can be moved effortlessly by means of two wheels.
It can be adapted to any floor unevenness thanks to two adjustable blocks.
All its components are soundproofed.



Apertura a pedal
Foot pedal opening
Ouverture à pédale



486022 27,00 368

Contenedor de desperdicios 95 lts
Waste bin 95 lts
Conteneur à ordures 95 lts

480664 21,00

Adhesivo para pedal
Sticker for pedal
Autocollant pour pédale

480662 21,00

Adhesivo trampilla
Sticker for lid
Autocollant pour trappe

486074 31,00 377

Contenedor de plástico con tapa
55 lts
Plastic bin with lid 55 lts
Conteneur 55 lts

485024 31,00

Ruedas
Wheels
Rouelles

Ⓢ Includido / Included / Inclus
Ⓞ Opcional / Optional / Optionnel



L	A	H	Kg	Barcode	€
625	600	1.255	46,0	080660	995,00
540	410	1.016	30,5	080662	900,00

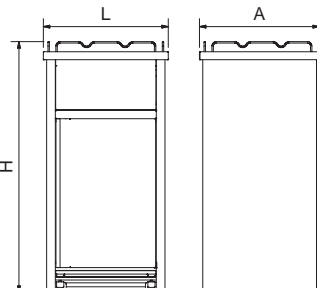

Caractéristiques de fabrication:

Fabriquée totalement en acier inoxydable.
Système patenté de pédale. Permettra à l'utilisateur ouvrir la trappe sans avoir besoin d'utiliser les mains. La trappe peut aussi être ouverte avec les mains.
Les tiges de la partie supérieure du meuble facilitent le rangement des plateaux.
La trémie de déchets est construite dans une seule pièce et elle ne possède pas de joints, ce qui facilite le nettoyage.
Tireur ergonomique.
La poubelle a deux rouelles, ce qui permet de le déplacer sans effort.
Elle est pourvue de deux vérins réglables en hauteur pour s'adapter au plancher.
Toute la poubelle est insonorisée.

Boxes modulares

Modular boxes
Boxes modulaires



Con este sistema de boxes modulares ya puede configurar a su medida las mesas, fregaderos, estanterías, etc.

Basados en las dimensiones internacionales GASTRONORM están fabricados totalmente en acero inoxidable. Su diseño moderno y funcional permite adaptar guías, cajones, cubetas, puertas etc.

With this system of modular boxes now you can adapt to your needs tables, sink units, shelving units, etc.

Avec le système de boxes modulaires maintenant vous pouvez adapter à vos besoins tables, éviers, étagères, etc.

Based in the international dimensions Gastronorm, it is made totally from stainless steel. Its innovative and functional design allows the fitting of elements such as guides, drawers, pans, doors, etc.

Ce système, basé dans les mesures internationales Gastronorm, est fabriqué totalement en acier inoxydable. Sa conception moderne et fonctionnelle permet d'adapter guides, tiroirs, bacs, portes, etc.

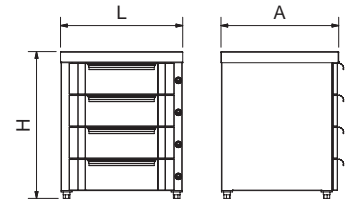

Posibilidad de acoplar ruedas a soportes de estantería.
Castor fixed to shelving supports possibility.
Possibilité de rouelle acouplée dans supports de rayonnage.



Box modular 4 cajones
Box 4 drawers unit
Box modulaire 4 tiroirs

L A H_{min} H_{max} GN Kg €

439 423 530 600 19,00 075002 **889,00**



Box modular 1 cajón y puerta
Box 1 drawer and door unit
Box modulaire 1 tiroir et porte

439 423 530 600 16,00 075004 **846,00**



Box modular guías GN
Box GN guides unit
Box modulaire GN guides

439 423 530 600 2/3 10,00 075006 **575,00**



Box modular 1 puerta
Box 1 door unit
Box modulaire 1 porte

439 423 530 600 13,00 075008 **648,00**

Kit golpeador para cajón modular

Coffee grounds striker kit for modular drawer
Kit de barre pour vider le marc de café pour tiroir modulaire

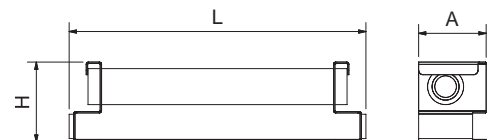
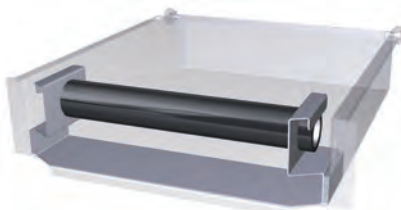

Precio para montaje en fábrica
Assembly price
Prix pour accoupler

€
075020 **22,00**

L A H Kg €
330 75,5 89 2,1 275128 **37,00**

Estanterías de sobremesa
 Desktop shelves
 Etagères à poser sur table



Estantes regulables en altura
 Adjustable shelves
 Etagères réglables en hauteur

Entrepañó opcional
 Optional shelf
 Tablette en option

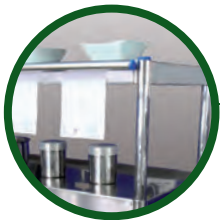

081802 € 25 431

Porta-notas mural
 Wall mounted note-holder
 Porte-notes mural



085014 € 8

Kit de fijación
 Fixing kit
 Kit de fixation

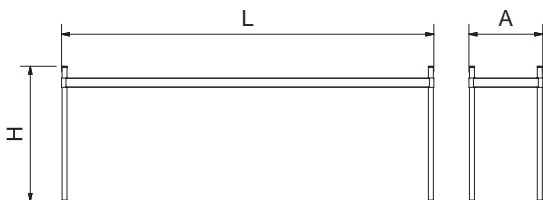

Instalación de sobremesa con o sin fijación.
 Installation on worktop with or without attachment.
 Installation sur dessus avec ou sans fixation.

L	A	H	Kg	Barcode	€	Kg	Barcode	€
991	391	677	3,8	076060	200,00	3,6	276060	100,00
1.391	391	677	5,1	076062	250,00	4,9	276062	125,00
1.891	391	677	6,7	076064	300,00	6,5	276064	150,00

Incluido / Included / Inclus

Opcional / Optional / Optionnel

Esterías suspendidas

Hanging wall shelves
Étagères suspendues



Fabricadas totalmente en acero inoxidable esta gama de estanterías suspendidas está diseñada para ayudarle a organizar su espacio de trabajo, con seguridad e higiene.

Los estantes son regulables en altura y cuentan con reborde perimetral que dará seguridad al contenido del estante evitando a su vez posibles derrames. Sus detalles de fabricación proporcionan firmeza y seguridad a toda la estructura.

Totally made in stainless steel. This range of hanging wall shelves is designed to help you to organize your working space in a safe and hygienic way. Their shelves are height adjustable, and are provided with a perimeter flange that will allow a secure storage and will avoid any accidental edge leakage. The particular manufacturing features provide stability and robustness to the whole structure.

Fabriquée entièrement en acier inoxydable cette gamme de rayonnages suspendus est conçue pour vous aider à organiser votre espace de travail en total sécurité et hygiène. Les étagères sont réglables en hauteur et ont un rebord qui donnera sécurité au contenu de l'étagère en empêchant les possibles déversements. Ces détails de fabrication fournissent fermeté et sécurité à toute la structure.



081802 25 431
Porta-notas mural
Wall mounted note-holder
Porte-notes mural



015400 44
Kit de fijación a techo para estanterías suspendidas
Ceiling fixing kit for hanging shelves
Kit de montage pour plafond pour étagères suspendues

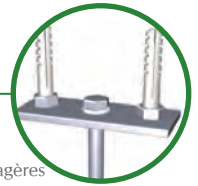

486024 18 373
Contenedor de desperdicios y reciclaje
Waste and recycling container
Conteneur à ordures et recyclage





454860 3,00 430
Cestillo para cubiertos
Cutlery basket
Couverts panier

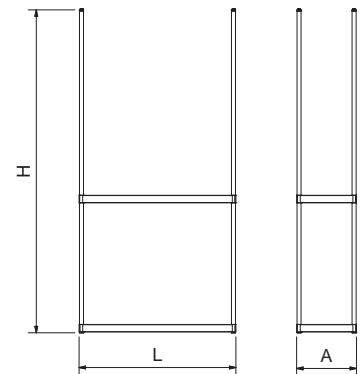

276042 26 312
Adaptador de cestillos cuberteros
Container adaptor for service trolleys
Adaptateur de panier à ustensiles de cuisine pour chariots de service



								
L	A	H	Kg	Barcode	€	Kg	Barcode	€
991	391	2.000	8,0	015402	310,00	3,6	276060	100,00
1.391	391	2.000	10,6	015404	375,00	4,9	276062	125,00
1.891	391	2.000	13,8	015406	450,00	6,5	276064	150,00

(I) Incluido / Included / Inclus
(Op) Opcional / Optional / Optionnel

Calentador de platos para estante de sobremesa

Dish heater for desktop shelves
Bande chauffante pour étagères à poser sur table

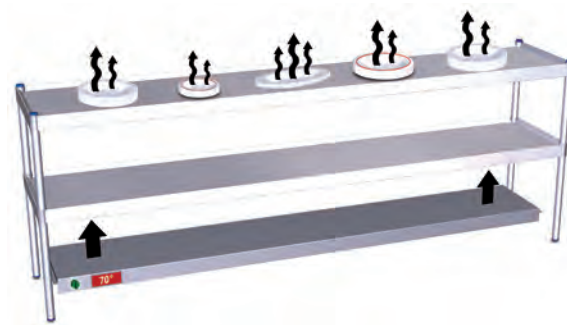

Características:

Instalación sin herramientas bajo estante de sobremesa.

Characteristics:

Tool-free installation under table shelf.

Caractéristiques:

Installation sans outil sous l'étagère de la table.

	Tensión Voltage Tension	Frecuencia Frequency Frecuence	Potencia Power Puissance			
L				Kg	€	
955	220 V	50 Hz	1.000 W	4,8	076070	450,00
1.355	220 V	50 Hz	1.500 W	6,0	076072	500,00
1.855	220 V	50 Hz	1.500 W	7,0	076074	550,00



Lámpara para calentar platos

Food warmer lamp
Lampe pour chauffer des plats

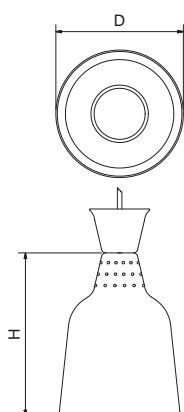

	Tensión Voltage Tension	Frecuencia Frequency Frecuence	Potencia Power Puissance			
D H				Gr	€	
180 300	220 V	50 Hz	250 W	800	476090	90,00

Plafón para calentar platos

Commercial radiant heater for food warming
Plafond pour chauffer des plats



Características:

Válido para acoplarlo bajo encimera o estante, incluye fijaciones, también admite la posibilidad de suspenderlo mediante las cadenas incluidas.

Characteristics:

Possibility of being assembled under worktop or under shelf. It can also be hung with the provided chains.

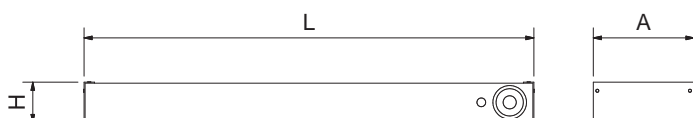

	Tensión Voltage Tension	Frecuencia Frequency Frecuence	Potencia Power Puissance			
L A H				Kg	€	
670 150 60	220 V	50 Hz	575 W	5,0	476092	625,00

Caractéristiques:

Apte pour s'ajuster sous le plan de travail ou étagère, les fixations sont incluses. Peut aussi se suspendre avec les chaînes qui sont incluses.

Dispensador de vasos

Cup dispenser
Distributeur de verres

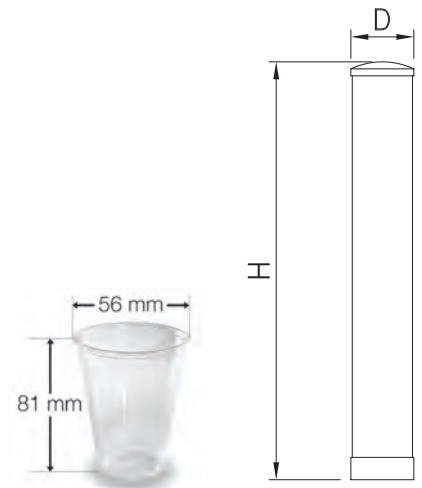

D	H	Gr	Barcode	€
90	597	450	483270	99,00

Puerta rodante para contenedores

Rolling door for waste bin
Porte roulante pour conteneur

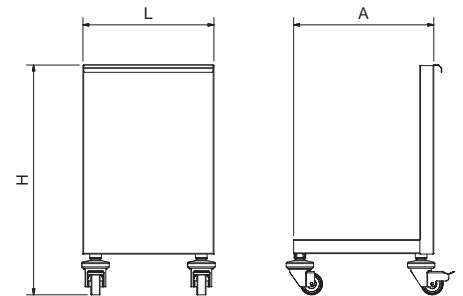

L	A	H	Kg	Barcode	€
460	500	780	11	074472	340,00

Peto lateral reversible para mesas

Reversible side upstand for tables
Dossier latéral réversible pour tables



Novedad
ew
nouveaux

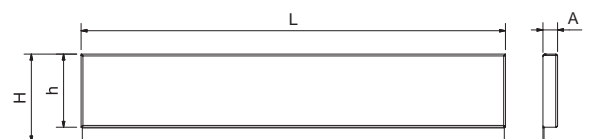

L	A	H	h	Kg	Barcode	€
480	20	120	100	0,98	070302	54,00
580	20	120	100	1,17	070304	56,00
680	20	120	100	1,37	070306	58,00

Tapa juntas de unión para mesas y fregaderos

Stainless steel flashing for tables and sinks
Couvre-joint pour union de tables et éviers

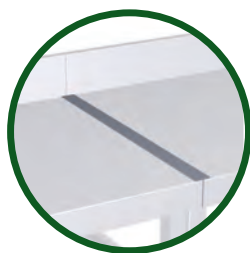

Novedad
ew
ouveau

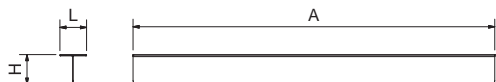

Características:

Válido para la unión entre mesas y/o fregaderos.

Characteristics:

Especially suitable for connecting tables and/or sinks.

Caractéristiques:

Valable pour l'union de tables et / ou éviers.

L	A	H	Gr	Barcode	€
475	35	39	320	074480	16,00
575	35	39	390	074482	16,00
675	35	39	460	074484	17,00

Fregaderos soldados a mesas

Sink units welded to tables
Eviers soudés aux tables

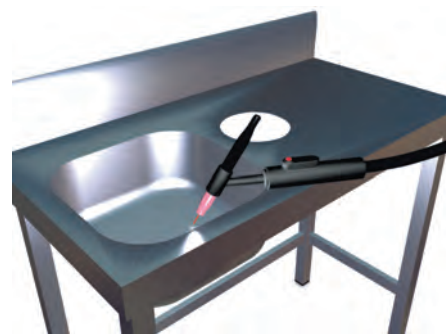

l	a	h	Gr	Barcode	€
260	Ø	115		057003	315,00
390	Ø	150		057005	344,00

370	340	145		057006	468,00
400	400	250		057008	375,00
400	400	300		057010	381,00
500	500	300		057012	416,00
500	500	350		057014	427,00
600	450	300	Gr	057016	515,00
600	450	300	Gr	057017	515,00
600	450	350	Gr	057018	531,00
600	450	350	Gr	057019	531,00
600	500	300	Gr	057020	520,00
600	500	300	Gr	057021	520,00
600	500	350	Gr	057022	534,00
800	420	350	Gr	057024	733,00
800	420	350	Gr	057026	733,00
1.060	420	350	Gr	057028	777,00
1.060	420	350	Gr	057030	777,00

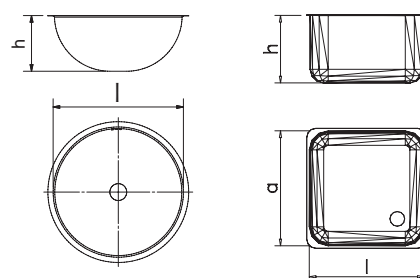

Armarios de puertas correderas

Cupboards with sliding doors
Armoires à portes coulissantes



Características:

Laterales y trasera forrados de acero inoxidable.

Entrepaño intermedio.

Tiradores integrados en la puerta.

Puertas colgadas, con lo que se evitan depósitos de suciedad en carriles y entrepaños.

Characteristics:

Back and sides covered with stainless steel panels. Centered shelf.

The main advantage of our sliding doors tables consists on their hanging doors. They avoid dirtiness deposits in rails and shelves. Furthermore the handles are integrated in the sheet.

Caractéristiques:

Latérales et retour recouvertes en acier inoxydable. Tablette-rayon centré.

La principale avantage de nos tables à portes coulissantes c'est que ses portes sont suspendues pour éviter des dépôts de saleté dans les rails et dans les tablettes-rayons. En plus les poignées sont intégrées dans la plaque.



Vista de mesa y armario.
Table and wardrobe view.
Vue de table et armoire.

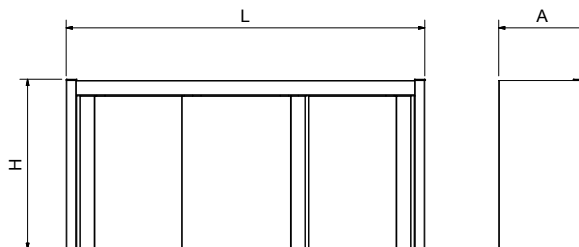

L	A	H		Kg		€
990	340	660	2	26,0	080806	748,00
1.390	340	660	3	36,0	080808	898,00
990	440	660	2	27,5	080802	823,00
1.390	440	660	3	36,0	080804	988,00

Armarios de puertas abatibles

Cupboards with hinged doors
Armoires à portes ouvrantes

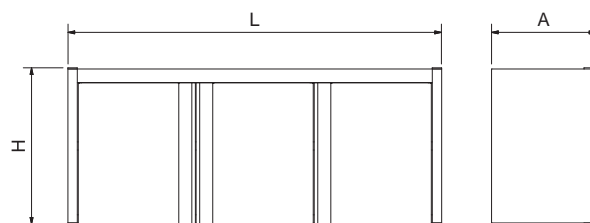
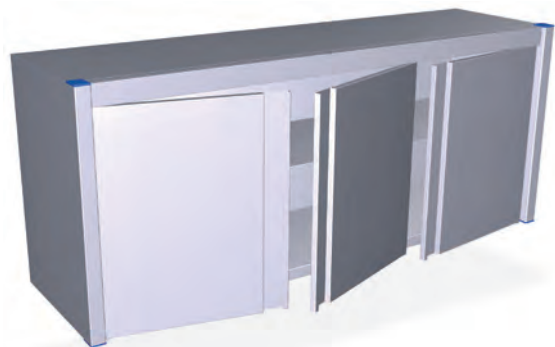

L	A	H		Kg		€
1.075	340	660	2	27	080810	787,00
1.575	340	660	3	42	080812	945,00
1.075	440	660	2	33	080814	866,00
1.575	440	660	3	48	080816	1.040,00



Armario de esquina derecha con puertas abatibles

Right corner cabinet with hinged doors
Armoire d'angle à droite avec portes ouvrantes

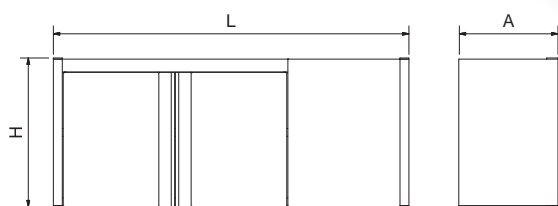
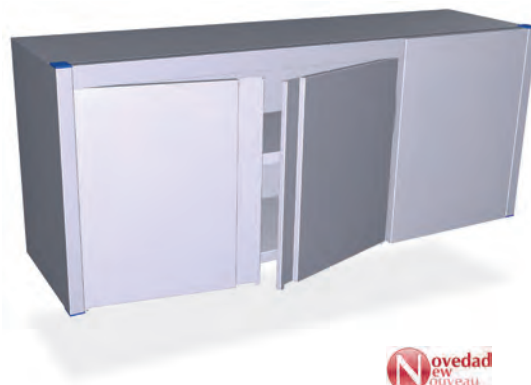
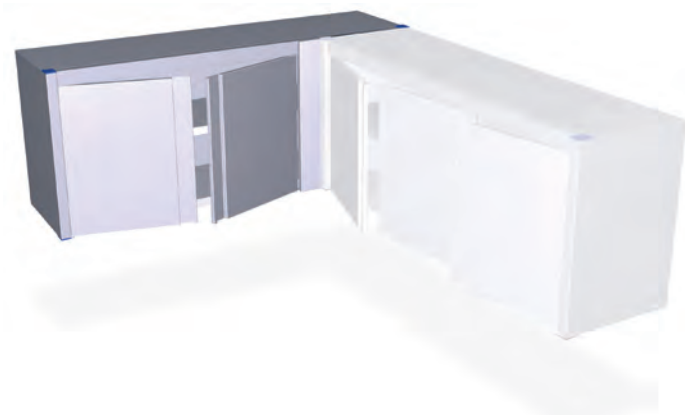

L	A	H		Kg		€
1.075	340	660	1	26	080820	787,00
1.575	340	660	2	41	080824	945,00
1.075	440	660	1	32	080828	866,00
1.575	440	660	2	47	080834	1.040,00

Armario de esquina izquierda con puertas abatibles

Left corner cabinet with hinged doors
Armoire d'angle à gauche avec portes ouvrantes

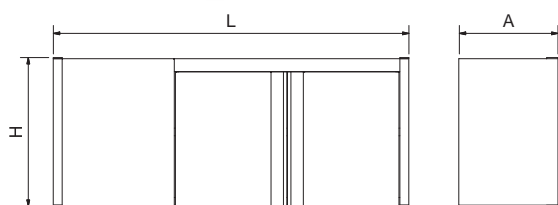
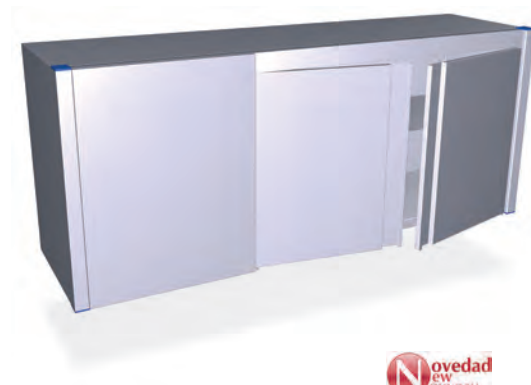

L	A	H		Kg		€
1.075	340	660	1	26	080818	787,00
1.575	340	660	2	41	080822	945,00
1.075	440	660	1	32	080826	866,00
1.575	440	660	2	47	080832	1.040,00

Armario para productos de limpieza

Wardrobe for cleaning products

Armoire pour produits d'entretien



Características:

Como dotación estándar lleva tres estantes en el lado derecho para la colocación de trapos, productos de limpieza, etc. Además, su diseño permite guardar cubos, recipientes grandes, escobas, fregonas, etc. Construido totalmente en acero inoxidable, acabado satinado, dispone de techo inclinado y 4 patas en altura de 115 mm para poder limpiar debajo de él. Estas patas están situadas de tal manera que salvan la curva sanitaria en la pared. Pies regulables. Ventilación mediante respiraderos embutidos. Pomo con posibilidad de acoplar candado. Ver página 336.



€



081612 240,00

Opción de kit de ozono acoplado.

Optional ozone kit coupled
kit ozone accouplé

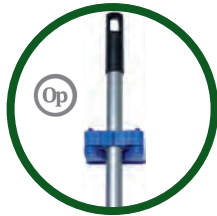

Set colgador sujeta-palos.
Handle-holder kit.
Kit porte-manches.

444

Opcional / Optional / Optionnel



Characteristics:

As standard equipment it has three shelves within one side for the placing of clothes, cleaning products, etc. At the same time its design allows to put in buckets, big containers, brooms, mops, etc. Made totally in stainless steel, satin finished, it has a reclined roof, legs of 115 mm height in order you can clean below. In addition, these legs are designed in such a way that saves the sanitary wall curve and at the same time they are adjustable. Ventilation by means of hammered vents and lock. A padlock can be placed onto the handle, see page 336.

Caractéristiques:

Comme équipement standard il a trois étagères dans une des côtes pour la placement des chiffons, produit d'entretien, etc. En plus, sa dessine permet garder seaux, récipients grands, balais, balais-serpillières, etc. Construit totalement en acier inoxydable, avec finition satiné, ils ont toit penché et empiètements de 115 mm d'hauteur pour qu'on peut nettoyer dessous. Ces empiètements sont dessinés tellement qui sauvent la courbe sanitaire du mur et en même temps sont réglables. Aération par soupiraux emboutis et serrure. On peut placer un cadenas dans le bouton, voir page 336.

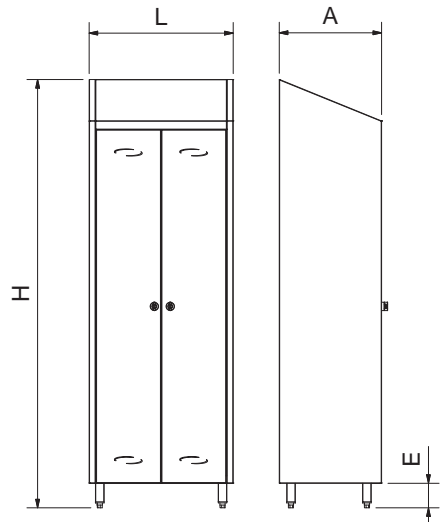

L	A	H	E		Kg		€
370	480	2.010	115	1	27	081412	625,00
680	480	2.010	115	2	45	081602	820,00



Consulten la posibilidad de acoplar un desinfectador-desodorizador por ozono en el armario.

Ask for the possibility of assembly a disinfectant-deodorizant by ozone in the wardrobe
Demandez-nous sur la possibilité de accoupler un désinfectant-désodorisant à l'ozone dans l'armoire

Posibilidad de acoplar ruedas ver pág 466

Possibility of assembly wheels, see page 466
Possibilité d'accoupler rouelles, voir page 466

Armario estantería 2 puertas
2 doors shelving wardrobe
Armoire rayonnage de 2 portes

Características:

Construido totalmente en acero inoxidable, acabado satinado, dispone de techo inclinado y 4 patas en altura de 115 mm para poder limpiar debajo de él. Estas patas están situadas de tal manera que salvan la curva sanitaria en la pared. Pies regulables. Ventilación mediante respiraderos embutidos. Pomo con posibilidad de colocar candado. Ver página 336.



Characteristics:

Made totally in stainless steel, satined finished, posses reclined roof, legs of 115 mm height in order you can clean below. In addition, these legs are designed in such a way that saves the sanitary wall curve and at the same time they are adjustable. Ventilation by means of hammered vents and lock. A padlock can be placed onto the handle, see page 336.

Caractéristiques:

Construit totalement en acier inoxydable, avec finition satiné, ils ont toit penché et empiétements de 115 mm d' haut pour qu' on peut nettoyer dessous. Ces empiétements sont dessinées tellement qui sauvent la courbe sanitaire du mur et en même temps sont réglables. Aération par soupiraux emboutis et serrure. On peut placer un cadenas dans le bouton, voir page 336.



***HASTA 190 Kg**
Up to 190 kgs of load strength
Jusqu' à 190 kgs de résistance



081612 € Op

Opción de kit de ozono acoplado.
Optional ozone kit coupled
kit ozone accouplé



***HASTA 500 Kg**
Up to 500 kgs of load strength
Jusqu' à 500 kgs de résistance

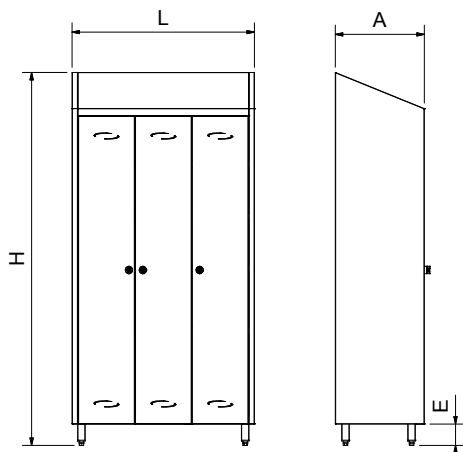

El pomo admite la colocación de candado.
Handle-holder kit.
Kit porte-manches.



Op Opcional / Optional / Optionnel



L	A	H	E					€
680	480	2.010	115	2	190	55	081650	900,00
980	480	2.010	115	3	500	66	081652	1.280,00



Posibilidad de acoplar ruedas ver pág 466
Possibility of assembly wheels, see page 466
Possibilité d' accoupler rouelles, voir page 466

Armario para equipos informáticos

Wardrobe for computer equipment
Cabinet pour matériel informatique



Características:

Construido totalmente en acero inoxidable, acabado satinado, dispone de techo inclinado y 4 patas en altura de 115 mm para poder limpiar debajo de él. Estas patas están situadas de tal manera que salvan la curva sanitaria en la pared. Pies regulables. Ventilación mediante respiraderos embutidos. Pomo con posibilidad de colocar candado. Ver página 336.

Characteristics:

Made totally in stainless steel, satined finished, posses reclined roof, legs of 115 mm height in order you can clean below. In addition, these legs are designed in such a way that saves the sanitary wall curve and at the same time they are adjustable. Ventilation by means of hammered vents and lock. A padlock can be placed onto the handle, see page 336.

Caractéristiques:

Construit totalement en acier inoxydable, avec finition satiné, ils ont toit penché et empiétements de 115 mm d' haut pour qu' on peut nettoyer dessous. Ces empiétements sont dessinées tellement qui sauvent la courbe sanitaire du mur et en même temps sont réglables. Aération par soupiraux emboutis et serrure. On peut placer un cadenas dans le bouton, voir page 336.



El pomo admite la colocación de candado.
Handle-holder kit.
Kit porte-manches.

336

Opcional / Optional / Optionnel

Posibilidad de acoplar ruedas ver pág 466
Possibility of assembly wheels, see page 466
Possibilité d'accoupler rouelles, voir page 466

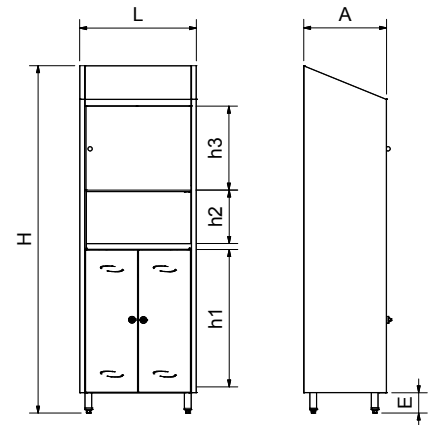

L	A	H	E	h1	h2	h3	Kg	Barcode	€
680	480	2.010	115	795	300	500	52	076402	1.250,00

Atril de acero inoxidable

Stainless steel desk
Pupitre en acier inoxydable



085480 190 464

Cajón acoplado
Drawer coupled
Tiroir accouplé

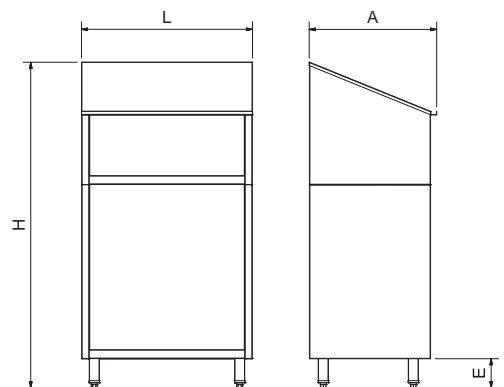

L	A	H	E	Kg	Barcode	€
678	505	1.290	115	22	074428	750,00

Novedad
New
nouveau



466

Ruedas
Wheels
Rouelles

Características:

Concebido para un uso intensivo profesional.

Estantes regulables en altura. Pliegues reforzados con pestaña aplastada, lo que evita accidentes durante su uso y limpieza y aumenta la capacidad de carga hasta 140 kg por nivel. Posibilidad de añadir más estantes. Máxima carga admisible 280 kg.

Se suministra con 4 ruedas giratorias, dos de ellas con freno, diámetro 125 mm, provistas de superficie de rodadura de baja sonoridad.

Parachoques circulares de 95 mm de diámetro.

Amplia gama de accesorios opcionales.



***HASTA 140 Kg**
de carga por estante

Up to 140 kgs of load strength per shelf
Jusqu'à 140 kgs de résistance par étage



486024



18



373



Contenedor de desperdicios y reciclaje azul
Coupled wheels
Rouelles accouplées

Characteristics:

Designed for intensive and professional work.

Adjustable shelves, reinforced by special fold with crushed fringe. This system avoids any bad cut when handling and cleaning it and increases its load strength. Every shelf can support up to 140 kgs evenly distributed. Possibility of increasing its number of shelves. Maximum load strength 280 kgs.

Provided with 4 castors of diameter 125 mm., 2 of them with brake, with tread band of low noise level.

Rounded bumpers of 95 mm. of diameter.

Wide range of optional accessories.



454860



3,00



430



Cestillo para cubiertos
Cutlery basket
Couverts panier



412



Cubetas Gastronorm
Gastronorm containers
Cuveau Gastronorm



276040



26



312



Adaptador de cubeta GN 1/3 y 1/6
Gastronorm trays adaptor GN/1/3 and 1/6 for service trolleys
Adaptateur de bacs Gastronorm 1/3 et 1/6 pour chariots de service



276044



32



312



Adaptador contenedor de desperdicios
Cutlery basket adaptor for service trolleys
Adaptateur de conteneurs pour chariots de service

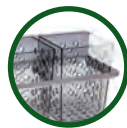

276042



26



312



Adpatador de cestillos cuberteros
Container adaptor for service trolleys
Adaptateur de panier à utensiles de cuisine pour chariots de service

Caractéristiques:

Conçu pour une utilisation intensive professionnelle.

Etagères réglables en hauteur. Plis renforcés avec bord aplati ce qui évite des accidents lors de son utilisation et nettoyage en plus d'augmenter sa capacité de charge jusqu'à 140 kg par niveau. Charge maximale : 280 kg. Il existe la possibilité d'ajouter des étagères.

Muni de 4 roulettes pivotantes, dont 2 avec frein, diamètre 125 mm et bande de roulage à bas niveau de bruit.

Pare-chocs ronds de 95 mm diamètre

Ample gamme de accessoires optionneaux.

										Entrepaino opcional Optional shelf Tablette en option	
L	A	H	Kg	Kg	Barcode	€	Kg	Barcode	€		
835	535	975	140	15	076002	385,00	3,5	276050	74,00		
1.035	535	975	120	16	076004	395,00	4,3	276052	90,00		
1.235	535	975	120	18	076006	450,00	5,0	276054	110,00		

*El peso máximo soportado está calculado para una carga repartida uniformemente sobre toda la superficie del estante.
The weight capacity is calculated for a uniformly distributed load over the entire surface of the shelf
La capacité de charge est calculée pour une charge uniformément répartie sur toute la surface du plateau

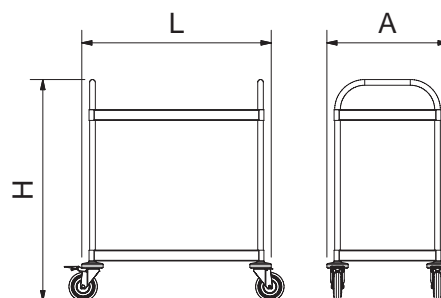

Adaptador de cubetas GN 1/3 y 1/6 para carros de servicio

Gastronorm trays adaptor GN 1/3 and 1/6 for service trolleys
Adaptateur de bacs Gastronorm 1/3 et 1/6 pour chariots de service

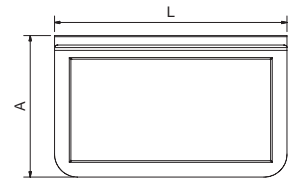

L	A	Gr	Barcode	€
355	216	780	276040	26,00

Adaptador de cestillos cuberteros para carros de servicio

Cutlery basket adaptor for service trolleys
Adaptateur de panier à utensiles de cuisine pour chariots de service

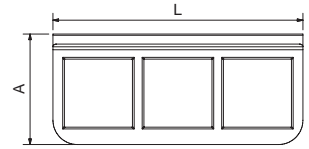

L	A	Gr	Barcode	€
360	159	792	276042	26,00

Adaptador de contenedores para carros de servicio

Container adaptor for service trolleys
Adaptateur de conteneurs pour chariots de service

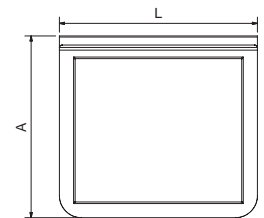

L	A	Gr	Barcode	€
315	289	764	276044	32,00

Carro de recogida

Collection trolley
Chariot de ramassage



Características:

Diseñado para facilitar la recogida de vajilla, cubiertos y desperdicios.
Estantes regulables en altura.
Ruedas de 125 mm de diámetro.
Alta resistencia.
Posibilidad de añadir más estantes.
Provisto de cubeta GN 1/2 de 200 mm. de profundidad y tolva de desbarasado.

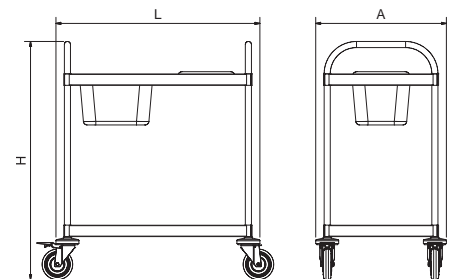

Characteristics:

Specially designed for the collection of cutlery, plates and waste.
Adjustable height.
Wheels diameter 125 mm.
Heavy duty.
Optional levels if required.
Provided with Gastronorm container 1/2-200 mm and waste chute.

Caractéristiques:

Conçu pour la collecte des couverts, assiettes et déchets.
Réglable en hauteur.
Roues en diamètre 125 mm.
Robuste.
Niveaux supplémentaires optionnels.
Fourni avec bac Gastro 1/2-200 mm et trémie vide-déchets.

L	A	H	Kg	Barcode	€
835	535	975	15,5	076020	450,00
1.035	535	975	16,5	076022	470,00
1.235	535	975	18,5	076024	570,00

Repuestos para carros de servicio y recogida

Spare parts for service and collection trolleys
Pièces de rechange pour chariots de service et ramassage

		Kg	Barcode	€
	Bastidor para carro de servicio Frame for service trolley Châssis pour chariot de service	1,8	276030	49,00
	Entrepaño para carro de servicio de 800x500 mm. Shelf for service trolley of 800x500 mm. Étagère pour chariot de service de 800x500 mm.	3,5	276050	78,00
	Entrepaño para carro de servicio de 1.000x500 mm. Shelf for service trolley of 1.000x500 mm. Étagère pour chariot de service de 1.000x500 mm.	4,5	276052	94,00
	Entrepaño para carro de servicio de 1.200x500 mm. Shelf for service trolley of 1.200x500 mm. Étagère pour chariot de service de 1.200x500 mm.	5,5	276054	116,00
	Rueda galvanizada con freno de diámetro 125 mm. Galvanized wheel of diameter 125 mm. with brake Roulette galvanisée avec frein diamètre 125 mm.	0,8	485010	19,00
	Rueda galvanizada sin freno de diámetro 125 mm. Galvanized wheel of diameter 125 mm. without brake Roulette galvanisée sans frein diamètre 125 mm.	0,7	485012	15,00
	Parachoques para carros de servicio Bumper for service trolleys Pare-chocs pour chariots de service	0,2	485050	3,00
	Kit de acoplamiento de rueda a bastidor de carros de servicio Wheel fixing kit for service trolleys frame Kit d'accouplement de roulette pour châssis de chariots de service	0,12	085014	8,00

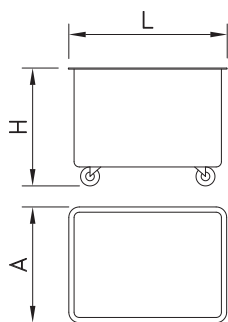

Carro de mantenimiento con ruedas y desagüe

Washing trolley with drain
Chariot à lavage avec écoulement

2 ruedas fijas y 2 giratorias de Ø 80 mm.
2 fixed wheels and 2 rotating wheels Ø 80 mm.
2 roues fixes et 2 roues tournantes Ø 80 mm.



L	A	H	lit	Kg	Barcode	€
750	550	560	155	8,20	481070	226,00

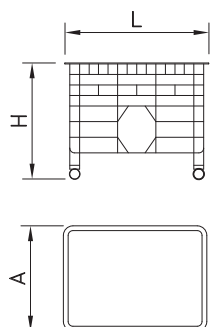

Contenedor para transporte de hielo

Trolley for ice transportation
Conteneur à ordures



Novedad
ew
ouveau

L	A	H	lit	Kg	Barcode	€
1.040	640	825	285 lts	19,50	481080	333,00

Contenedor para hielo

Trolley for ice transportation
Conteneur à ordures



Características:

Preparados para contacto alimenticio.
Fabricado en polietileno de alta densidad (HDPE).
Soporta temperaturas de -20° hasta +70°.
Con tapon para desagüe.

Characteristics:

Suitable for food contact.
Made of high-density polyethylene (HDPE).
It withstands temperatures from -20°C to +70°C.
With drain plug.

Caractéristiques:

Apte pour le contact alimentaire.
Fabriqué en polyéthylène de haute densité (HDPE).
Résiste à des températures allant de -20° jusqu'à +70°.
Avec bouchon pour l'évacuation.

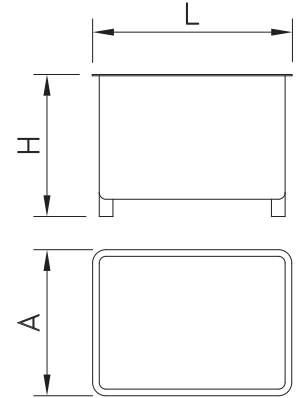

481074 308,00



Base rodante galvanizada
Galvanized rolling base
Base roulante galvanisée

L	A	H	lit	Kg	Barcode	€
790	600	685	210	8,80	481072	289,00

Carro bañera para elevador

Tote bin for lift
Chariot baignoire pour élévateur

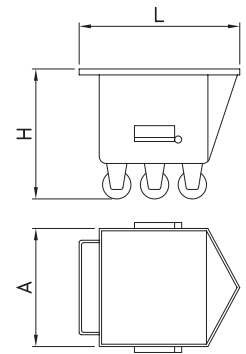

L	A	H	lit	Kg	Barcode	€
680	500	550	100	34	481076	790,00
800	650	690	200	40	481078	830,00

Carros Gastronorm

Gastronorm trolleys
Chariots Gastronorm



Características:

4 ruedas giratorias, 2 de ellas con freno.

Characteristics:

4 swivel wheels, 2 of them with brakes.

Caractéristiques:

4 roues pivotantes, dont 2 avec freins.

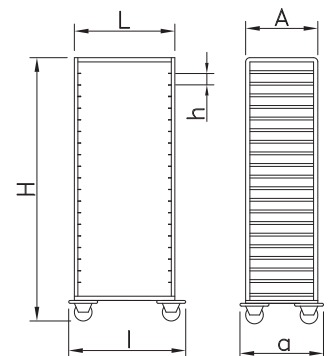

L	A	H	h	a	I	CN	lit	Kg	Barcode	€
380	555	1.865	78	700	535	1/1	20	16	476020	490,00
585	670	1.865	78	740	655	2/1	20	21	476022	530,00

Carro Euronorm

Euronorm tray trolley
Chariot pour plateaux Euronorm

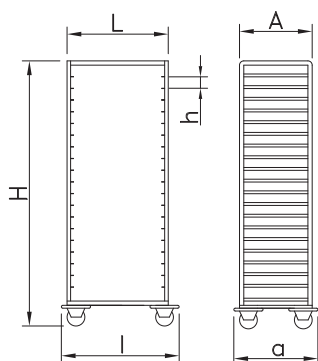

Características:
4 ruedas giratorias, 2 de ellas con freno.

Characteristics:
4 swivel wheels, 2 of them with brakes.

Caractéristiques:
4 roues pivotantes, dont 2 avec freins.

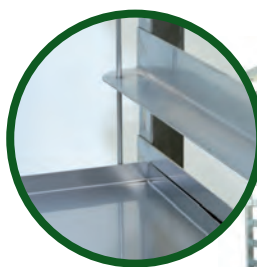

L	A	H	a	l	h				€
465	630	1.815	700	535	78	20	19	476010	545,00

Carro de transporte

Platform trolley
Chariot à plate-forme

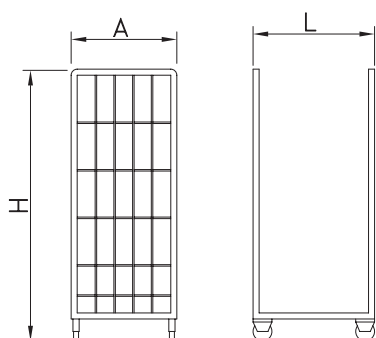

Características:
Acabado en cincado electrolítico.
2 ruedas giratorias y 2 fijas.

Characteristics:
Electrolytic zinc finishing.
2 swivel wheels and 2 fixes wheels.

Caractéristiques:
Finition en zinc électrolytique.
2 roues pivotantes et 2 roues fixes.



L	A	H				€
700	800	1.800	600	22	476002	138,00

Carro para canales

Carcass trolley
Chariot à carcasses

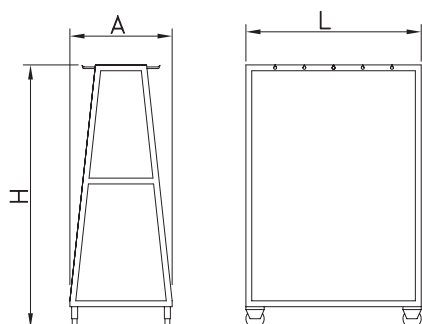

Características:
4 ruedas giratorias.
Estante inferior movable.
Estructura del tubo 40x40 mm.

Characteristics:
4 swivel wheels.
Detachable lower level.
Tube 40x40 mm.

Caractéristiques:
4 roues pivotantes.
Niveau inférieur amovible.
Tube 40x40 mm.



***HASTA 500 Kg**
Up to 500 kgs
Jusqu'à 500 kgs



L	A	H			€
1.200	700	1.800	38	476030	1.478,00

Palet para jamones

Palet for cured hams
Palette pour jambons



Características:

3 niveles.
1º y 3º nivel: 4 tubos.
2º nivel: 3 tubos.
Total 11 tubos y 55 ganchos del código 022702.
Posibilidad por parte del cliente de regular la altura de los niveles y de la colocación de los tubos en cada nivel.
Posibilidad de añadir tubos adicionales.
Remontable. Máximo 2 palets.
Fácil transporte.
Desmontable.
Máxima capacidad de carga por palet: 300 Kgs. Uniformemente repartidos entre todos los niveles y en el nivel.
Máxima capacidad de carga por palet remontando: 150 Kgs. Uniformemente repartidos entre los dos palets, entre todos los niveles y en cada nivel.
Se puede manejar con transpaleta.
Construido en acero galvanizado.
Posibilidad de acoplar ruedas.

Characteristics:

3 levels.
1st and 3rd levels: 4 tubes.
2nd level: 3 tubes.
Total: 11 tubes and 55 hooks ref. 022702.
The customer has the possibility of adjusting the height of the levels and placing the tubes on each level.
Possibility of adding additional tubes.
Stackable up to 2 pallets.
Easy to move.
Detachable.
Maximum load strength, non-stacked: 300 kgs evenly distributed on each level.
Maximum load strength, stacked: 150 kgs evenly distributed on each level.
It can be transported with a forklift.
Made in Galvanized steel.
Possibility of wheels assembly.

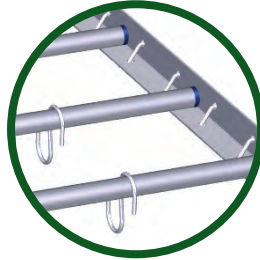

466



Ruedas
Wheels
Rouelles



Caractéristiques:

Elle a 3 niveaux.
1º et 3º niveau: 4 tubes.
2º niveau: 3 tubes.
Total 11 tubes et 55 crochets 022702.
Possibilité de régler la hauteur des niveaux et l'emplacement des tubes à chaque niveau.
Possibilité d'ajouter des tubes supplémentaires.
Remontable-Maximum 2 palettes.
Transport facile.
Démontable.
Capacité max de charge par palette: 300 Kgs. Uniformément répartis entre tous les niveaux et sur le niveau.
Capacité max de charge par palette remontante: 150 Kgs. Uniformément répartis entre tous les niveaux et sur le niveau.
On peut la manipuler avec transpalette.
Fabriquée en acier galvanisé.
On peut ajouter des rouelles.

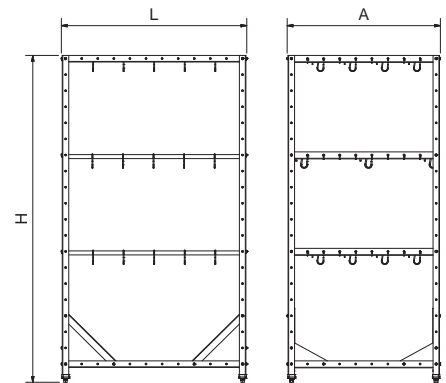

Op Opcional / Optional / Optionnel

L	A	H	Kg	Barcode	€
1.153	953	2.033	46	076040	426,00

Palet para embutidos

Pallet for sausages and cured meat
Séchoir charcuterie démontable en palette

Características:

4 niveles y 6 tubos por nivel.
Regulación en altura de los niveles y tubos.
Posibilidad de añadir tubos adicionales.
Remontable. Máximo 2 palets.
Fácil transporte.
Desmontable.
Máxima capacidad de carga por palet: 300 KGS. Uniformemente repartidos entre todos los niveles y en el nivel.
Máxima capacidad de carga por palet remontando: 150 KGS Uniformemente repartidos entre los dos palets, entre todos los niveles y en cada nivel.
Se puede manejar con transpaleta.
Construido en acero galvanizado.

Characteristics:

4 levels and 6 tubes per level.
The levels and tubes can be adjusted.
Possibility of mounting additional elements.
Stackable up to 2 pallets.
Easy to transport.
Detachable.
Maximum load strength, non-stacked: 300 kg per pallet, evenly distributed on each level.
Maximum load strength, stacked: 150 kg per pallet, evenly distributed on each level.
Can be transported with a forklift.
Made in galvanized steel.

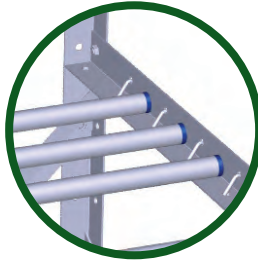

466



Ruedas
Wheels
Rouelles

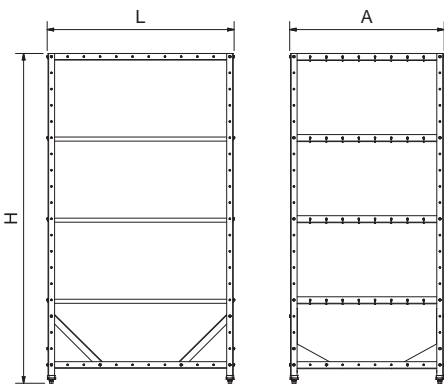

Caractéristiques:

Il a 4 niveaux.
6 tubes par niveau, total 24 tubes.
Possibilité de régler la hauteur des niveaux par le client et possibilité de choisir l'emplacement des tubes dans chaque niveau.
Possibilité d'ajouter des tubes additionnels.
Possibilité d'empiler. Maximum 2 palettes.
Transport facile.
Démontable.
Capacité maximale de charge par palette: 300 kg uniformément repartis.
Capacité maximale de charge par palette remontée: 150 kg uniformément repartis.
On peut le transporter avec transpalette.
Fabriqué en acier galvanisé.

L	A	H	Kg	076050	€
1.153	953	2.033	55	076050	450,00

Includo / Included / Inclus

Opcional / Optional / Optionnel



Mostrador de pescadería con soporte

Floor-mounted fish counter
Étal à poisson avec support

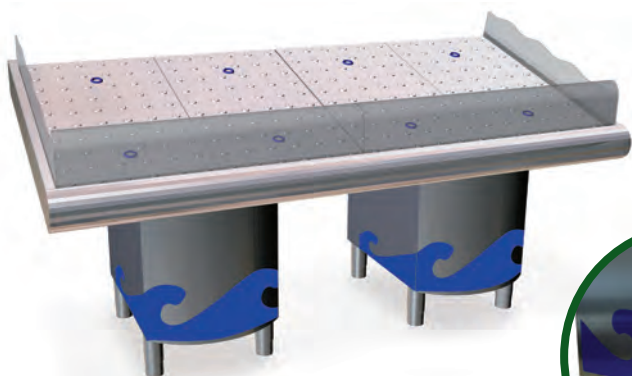

Características:

Fabricado totalmente con acero inoxidable AISI 304, está diseñado para adaptarse a las necesidades de los diferentes establecimientos.

Characteristics:

Wholly made of stainless steel AISI 304, it has been designed to meet the needs of any establishment.

Caractéristiques:

Fabriqu e totalement en acier inoxydable AISI 304, c'est con u pour subvenir les besoins de tous les  tablissements.

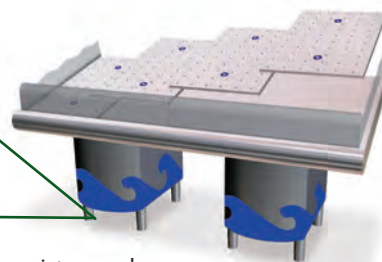
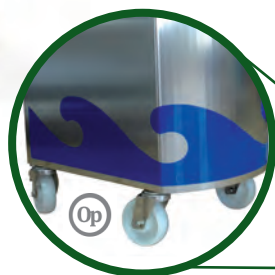

Tacos regulables
Protector frontal curvado transparente
Laterales transparentes
Bandejas perforadas
Desag es
Conectores r pido desag es
Mangueras desag es
Puertas desmontables
Juego de adhesivos ola para los frentes

Adjustable blocks
Front and sides in plastic
Perforated trays
Drainers
Quick connectors hoses
Drains hoses
Rear detachable doors
Set of decorative stickers "Ola"

Taquets r glables
Front et flancs en plastique
Plateaux perfor es
D versoirs
Connecteurs rapide pour tuyaus
Tuyaus d versoirs
Portes post rieures amovibles
Jeu d'autocollants d coratives

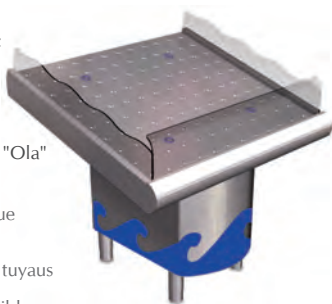

Mediante un novedoso sistema de bandejas conseguimos que el hielo permanezca sujeto a la exposici n, evitando su desplazamiento hacia la parte delantera. A diferencia de otros expositores, con nuestro dise o ahorraremos energ a y agua, pues con una capa menor de hielo conseguiremos exponer mejor el producto.

By means of a new trays system we achieve the ice to remain fixed to the counter and we avoid it to slide to the front side. Unlike other counters, with this new system we will save both water and energy, since with a thinner sheet of ice you will be able to exhibit your products in the best conditions.

Gr ce   un nouveau syst me de plateaux nous atteindrons que le glace reste fixe au comptoir et nous  vitons qu'elle se glisse vers la partie inf rieure. Contrairement   autres  tals, avec ce syst me vous  pargnerez de l'eau et de l' nergie, puisque avec une couche de glace plus fine vous pourrez exposer vos produits dans les meilleures conditions.



Mediante la regulaci n de los pies podemos incrementar la altura hasta 50 mm m s.

By the adjustment of the legs you can increase the height up to 50 mm.

Par le r glage des pieds vous pouvez incr menter l'hauteur jusqu'  50 mm.

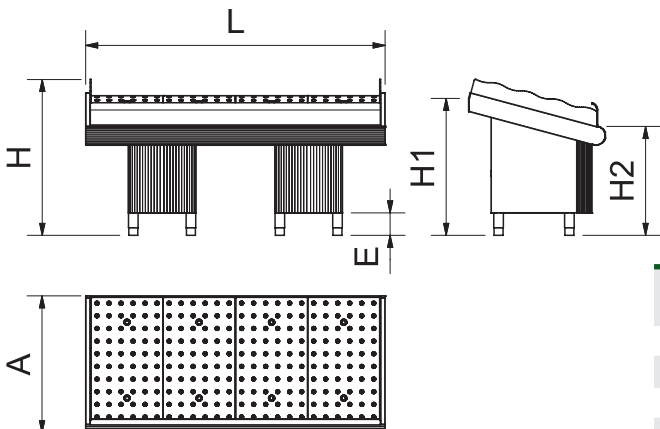

L	A	H	H1	H2	E		Kg		�
985	950	1.045	960	730	150	1	51	074439	1.450,00
1.465	950	1.045	960	730	150	2	78	074445	1.950,00
1.950	950	1.045	960	730	150	2	116	074440	2.400,00
2.912	950	1.045	960	730	150	2	120	074444	3.200,00

Características:

Fabricado totalmente con acero inoxidable AISI 304, está diseñado para adaptarse a las necesidades de los diferentes establecimientos.

Characteristics:

Wholly made of stainless steel AISI 304, it has been designed to meet the needs of any establishment.

Caractéristiques:

Fabriqué totalement en acier inoxydable AISI 304, c'est conçu pour subvenir les besoins de tous les établissements.

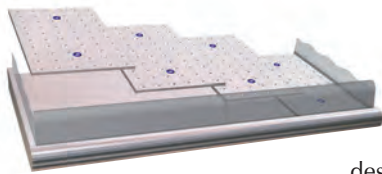
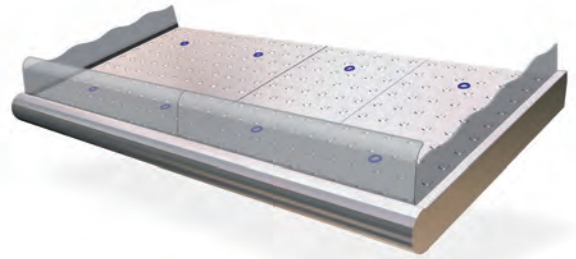

Mediante un novedoso sistema de bandejas conseguimos que el hielo permanezca sujeto a la exposición evitando su desplazamiento a la parte delantera.

A diferencia de otros expositores con nuestro diseño ahorraremos energía y agua pues con una capa menor de hielo conseguiremos exponer mejor el producto.

Protector frontal curvado transparente
Laterales transparentes
Bandejas perforadas pescaderías
Desagües
Mangueras desagües

By means of a new trays system we achieve the ice to remain fixed to the counter and we avoid it to slide to the front side. Unlike other counters, with this new system we will save both water and energy, since with a thinner sheet of ice you will be able to exhibit your products in the best conditions.

Front and sides in plastic
Perforated trays
Drainers
Drains hoses

Front et flancs en plastique
Plateaux perforés
Déversoirs
Tuyaus déversoirs

Grâce à un nouveau système de plateaux nous atteindrons que le glace reste fixe au comptoir et nous évitons qu'elle se glisse vers la partie inférieure. Contrairement à autres étals, avec ce système vous économiserez de l'eau et de l'énergie, puisque avec une couche de glace plus fine vous pourrez exposer vos produits dans les meilleures conditions.

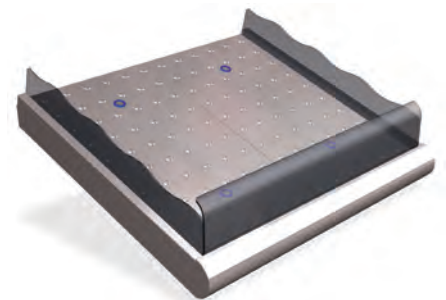
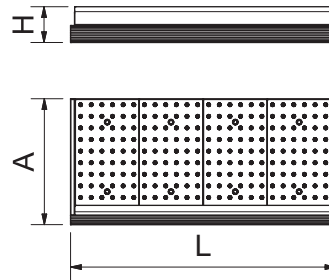

L	A	H	Kg	Barcode	€
985	950	270	25	074441	850,00
1.465	950	270	33	074447	1.150,00
1.950	950	270	48	074442	1.350,00
2.912	950	270	70	074446	2.150,00

Prolongación modular para mostrador de pescadería

Modular extension for fish counter
Extension modulaire pour étal à poisson



Contenido:

Tacos regulables
Laterales transparentes
Dos bandejas perforadas

Included:

Adjustable feet
Transparent sides
Two perforated trays

Inclus:

Pieds réglables
Côtés transparents
Deux plateaux perforés

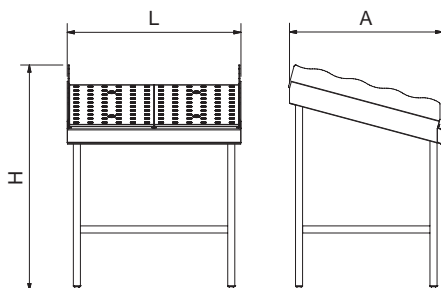
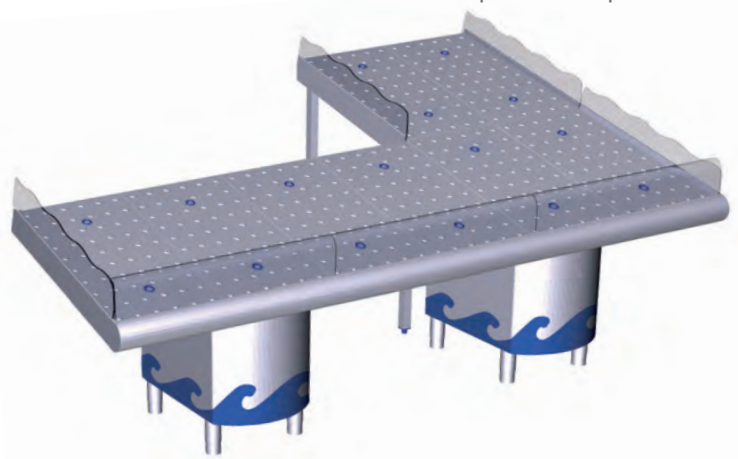

Características:

Con esta ampliación modular del mostrador podrá duplicar la zona de exposición en la zona que más le interese. Desmontable, movable y regulable en altura.

Characteristics:

This modular extension will allow you make double your display space at the required area. It is detachable, movable and with adjustable height.

Caractéristiques:

Cette extension modulaire vous permettra doubler votre espace d'exposition à la zone nécessaire. Elle est amovible, mobile et réglable en hauteur.

L	A	H	Kg	Barcode	€
985	867	1.279	29,5	074462	1.155,00



074444 3.200,00 318



Mostrador de pescadería con soporte
Floor-mounted fish counter
Étal à poisson avec support

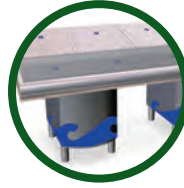

074462 1.155,00 319



Prolongación modular para mostrador de pescadería
Modular extension for fish counter
Extension modulaire pour étal à poisson

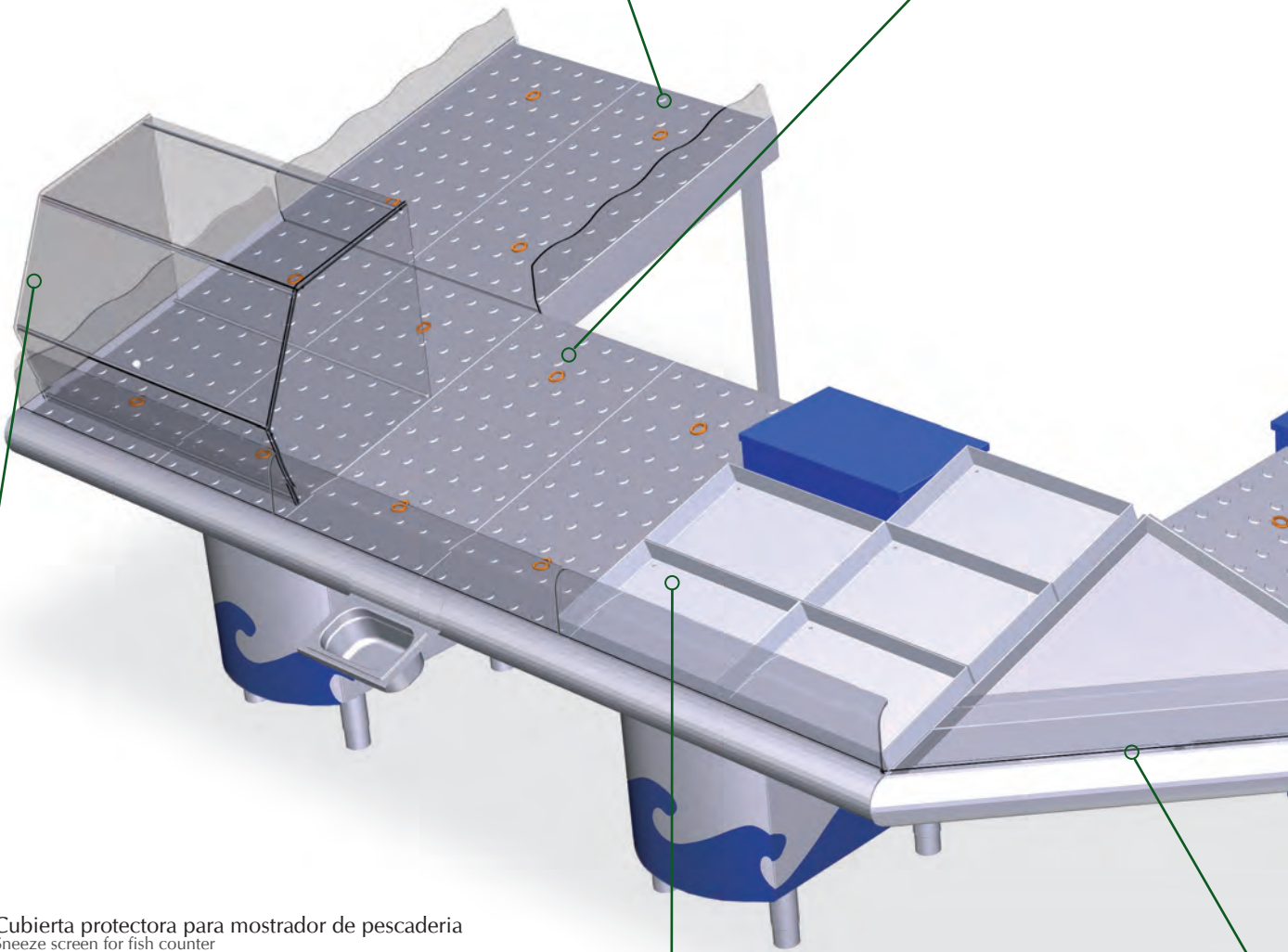

Cubierta protectora para mostrador de pescadería
Sneeze screen for fish counter
Vitre de protection pour étal à poisson

L	A	H	Kg	Barcode	€
960	500	572	4,80	074464	286,00

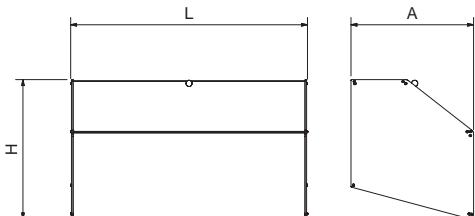

083420 35,00 426



Bandeja para marisco
Seafood tray
Plateau inox pour fruits de mer

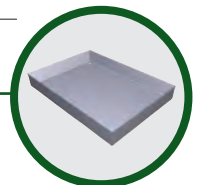



074460



180,00



326

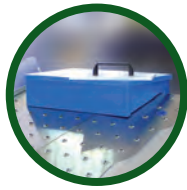

Tajo-expositor para mostrador de pescadería
Polyethylene cutting board-display for fish counter
Plaque de découpe-exposant en polyéthylène pour étal à poisson

Unión en escuadra interior para mostradores de pescadería
Fish counter internal-corner link
Jonction d'angle interne pour étal à poisson

L	A	H	Kg	Barcode	€
1.230	870	118	8,00	074449	330,00

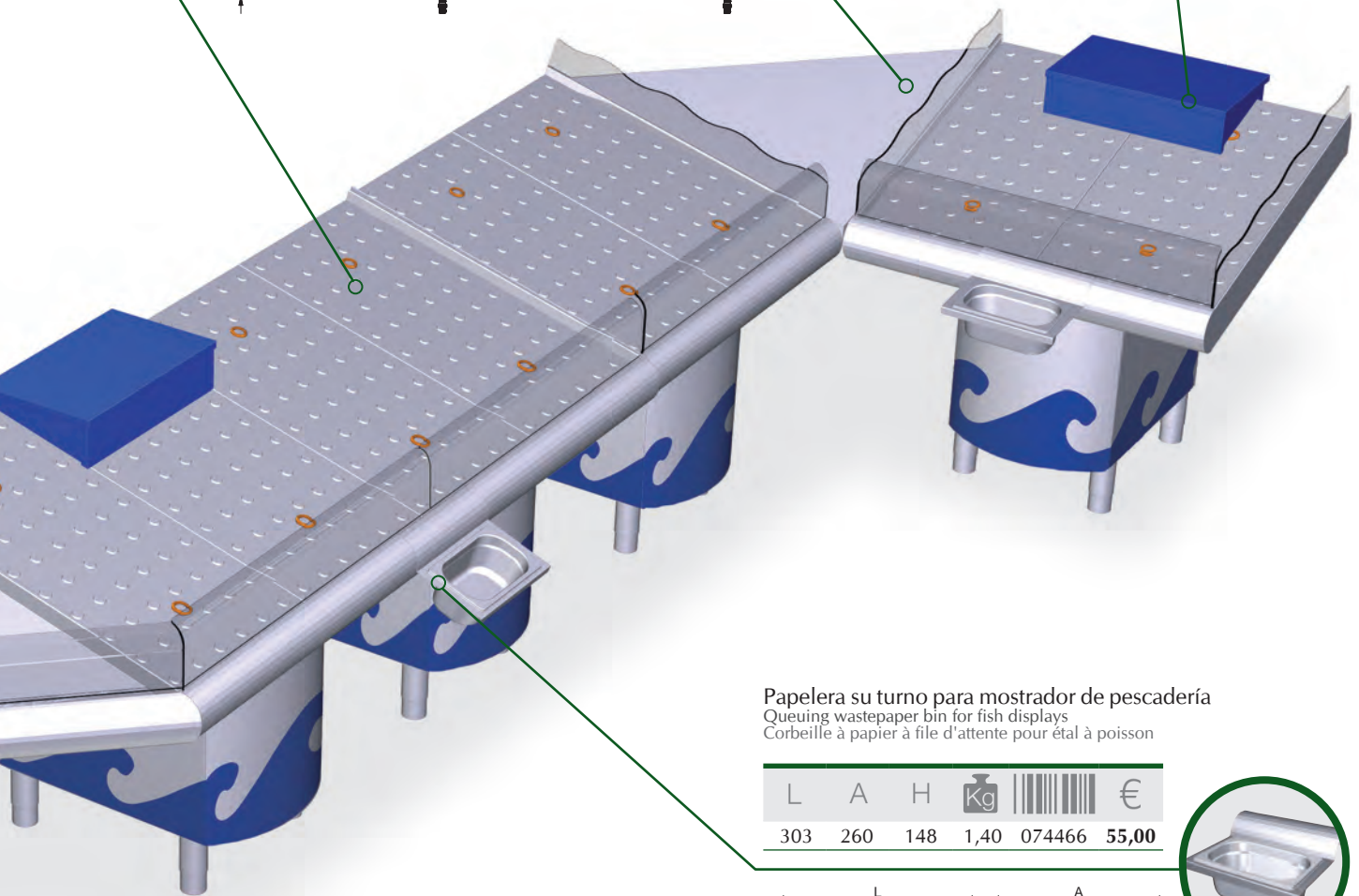
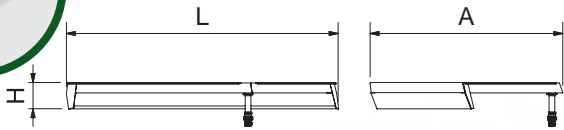

Papelera su turno para mostrador de pescadería
Queuing wastepaper bin for fish displays
Corbeille à papier à file d'attente pour étal à poisson

L	A	H	Kg	Barcode	€
303	260	148	1,40	074466	55,00

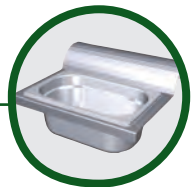
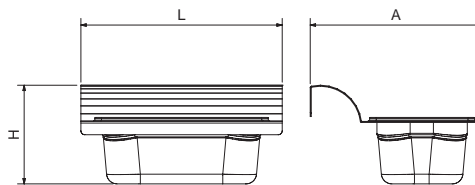

Unión en escuadra exterior
Fish counter external corner link
Jonction d'angle pour étal à poisson

L	A	H	Kg	Barcode	€
1.290	960	256	11,00	074448	495,00

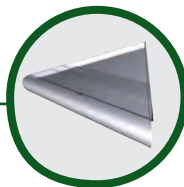
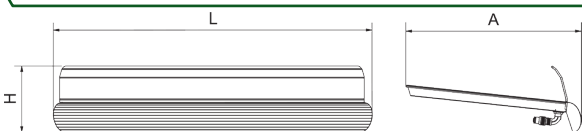







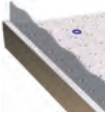

Repuestos para mostradores de pescadería

Spares parts for fish counter

Rechanges pour étals à poisson



	<p>Frontal curvado transparente de 963 mm. Curved transparent front panel 963 mm. Panel courbe transparent 963 mm.</p>	550	274490	154,00
	<p>Lateral transparente Transparent side panel Panel latéral</p>	410	374460	30,00
	<p>Bandeja perforada para mostrador de pescadería Perforated tray for fish counter Plateau perforé pour comptoir à poisson</p>	3.000	274476	80,00
	<p>Pie regulable inox de Ø 63,5x150 mm. Adjustable stainless foot ø63,5x150 mm. Pied réglable inoxydable ø63,5x150 mm.</p>	200	409856	6,00
	<p>Adhesivo modelo "Ola" "Wave" model sticker Autocollant modèle "vague"</p>	80	474468	50,00
	<p>Adhesivo hieba. Sticker "Grass". Adhésif gazon.</p>	90	474466	50,00
	<p>Desagüe de poliamida blanca 3/4" L= 90 mm. White polyamide drain 3/4" L=90 mm. Déversoir en polyamide 3/4" L= 90 mm.</p>	90	474460	2,00
	<p>Abrazadera sin fin de 25-40 mm. para manguera Worm drive hose clamp 25-40 mm. Collier de serrage sans fin de 25-40 mm pour tuyau</p>	5	460453	1,20
	<p>Manguera flexible de 1" Flexible hose 1" Tuyau flexible 1"</p>		474478	mt. 3,75
	<p>Pasacable azul Ø 36x2,5 mm. Blue passcable Ø 36x2,5 mm. Passecâble bleu Ø 36x2,5 mm.</p>	0,006	409830	0,50

Dotación y características de fabricación:
Totalmente construida con acero inoxidable.
Fibra de polietileno calidad P-500.
Fregadero soldado con válvula, tapón y rebosadero.
Tolva de evacuación de desperdicios.

Features and manufacturing characteristics:
Made totally from stainless steel.
P-500 quality polyethylene fibre.
Welded bowl with valve, plug and overflow.
Hole for waste-chutes

Dotation et caractéristiques de fabrication:
Entièrement fabriquées en acier inoxydable.
Fibre de polyéthylène qualité P-500.
Bac soudée avec valve, déversoir.
Trou pour tremie à déchets.



Novedad
New
nouveau





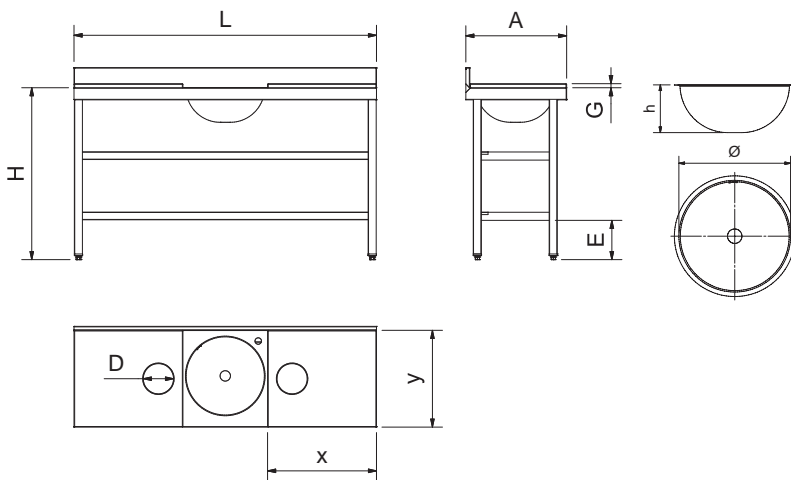

 **Repuestos de fibras.**
Spare fibres.
Fibres de rechange.

 82



 Opcional / Optional / Optionnel

	L	A	H	E	Ø	h	X	y	G	D	Kg	Barcode	€
	1.000	500	850	200	390	170	540	480	20	150	23,5	072802 072880 072852	756,00
	1.000	500	850	200	390	170	540	480	20	150	23,5	072810 072882 072860	756,00
	1.500	500	850	200	390	170	540	480	20	150	30,0	072812 072884 072862	935,00
	1.500	500	850	200	390	170	540	480	20	150	30,0	072820 072886 072870	935,00
	1.500	500	850	200	390	170	540	480	20	150	34,0	072822 072888 072872	1.059,00

Puesto pescadero encimera polietileno

Fish preparation table with polyethylene worktop
Table de preparation de poisson dessus en polyéthylène



Características:

Su peto trasero en plástico permite trabajar cómodamente de cara al público y evitar salpicaduras. El precio incluye el portacuchillos para adosar con envolvente.

Characteristics:

Plastic back fringe that allows an agreeable work face to the public and to avoid splashing. Provided with mounted knife holder with wrapping.

Caractéristiques:

Pan coupé postérieur en plastique qui permet travailler commodément face au public et éviter des éclaboussures. Pourvu avec porte-couteaux pour adosser avec enveloppant.

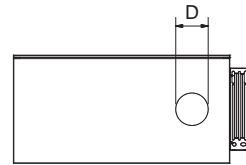
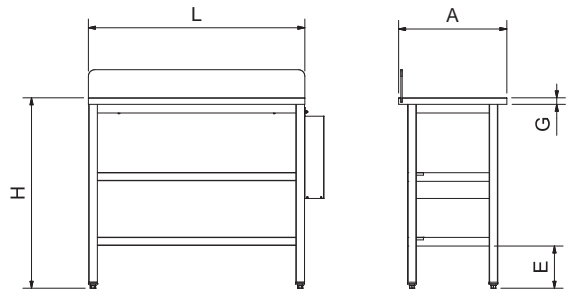

Repuestos de fibras.
Spare fibres.
Fibres de rechange.



82

L	A	H	D	G	E	Kg	Barcode	€
1.000	500	850	150	30	200	20	074424	620,00

Puesto pescadero modelo sencillo

Fish preparation table simple model
Table de préparation de poisson modèle simple

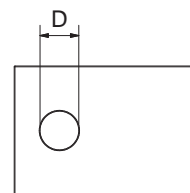
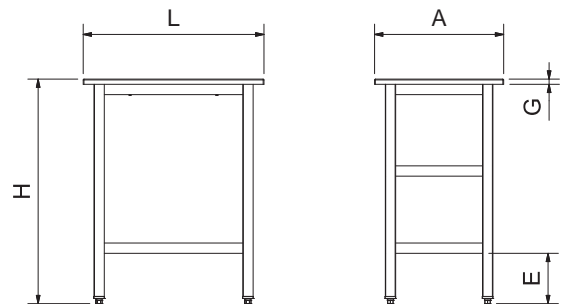

Repuestos de fibras.
Spare fibres.
Fibres de rechange.



82

L	A	H	X	Y	D	G	E	Kg	Barcode	€
700	500	850	400	500	235	20	200	18	074404 074407 074406	375,00

Mesa para marisco
Seafood table
Table pour fruits de la mer



Novedad
ew
ouveau

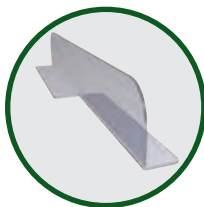

074451

€ 29



Separador para mesa de marisco
Separator for seafood table
Séparateur pour table pour fruits de la mer

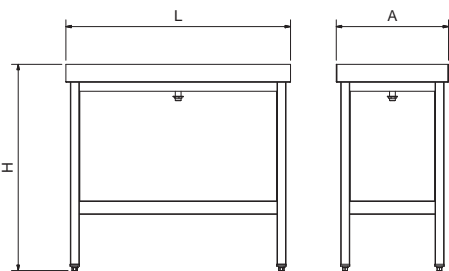
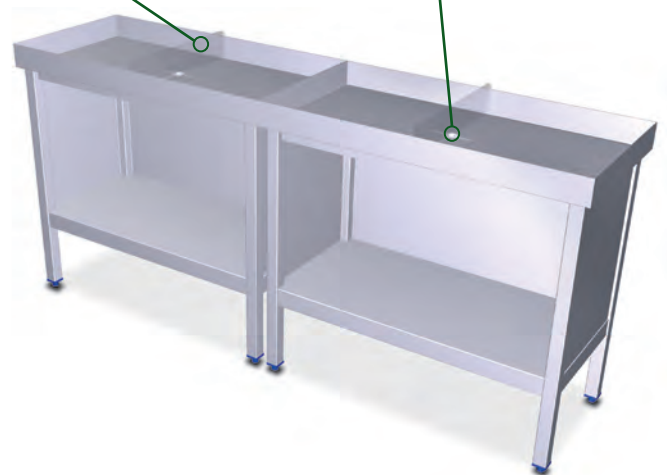
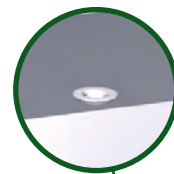

L	A	H	Kg	Barcode	€
1.000	500	917	27,2	074450	830,00

Opcional / Optional / Optionnel

Tajo-expositor para mostrador de pescadería

Polyethylene cutting board-display for fish counter
Plaque de découpe-exposant en polyéthylène pour étal à poisson

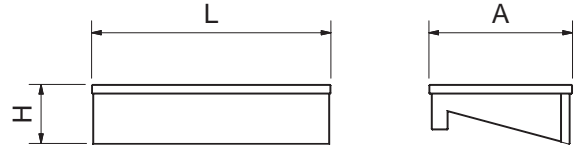
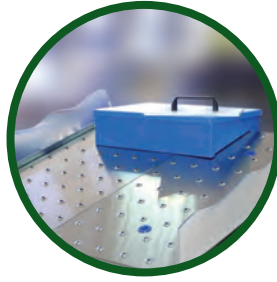

L	A	H	Kg	Barcode	€
500	300	125	4,70	074460	180,00

Paleta de fibra para aplastar hielo

Polyethylene trowel for crushing ice
Truelle en polyéthylène pour piler la glace

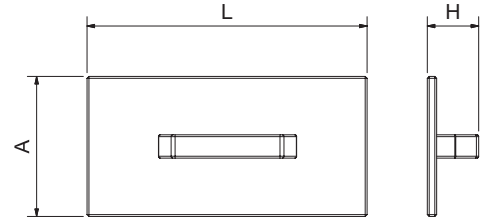

L	A	H	Gr	Barcode	€
300	150	55	500	032202	29,00

Pala para hielo

Ice spade
Pelle à glaçons



Características:

Su fabricación en polipropileno garantiza:
No absorbe agua.
No pierde su dureza en condiciones de humedad.
Puede ser esterilizado (no en autoclave).
Soporta temperaturas de hasta 100°C.

Characteristics:

It is made of polypropylene, which guarantees:
No water absorption.
No loss of hardness in humidity conditions.
Possibility of sterilization.
It resists temperatures up to 100°C.

Caractéristiques:

Sa fabrication en polypropylène garantit:
Pas d'absorption d'eau.
Pas de perte de dureté dans conditions d'humidité.
Possibilité de stérilisation.
Supporte température jusqu'à 100°C.

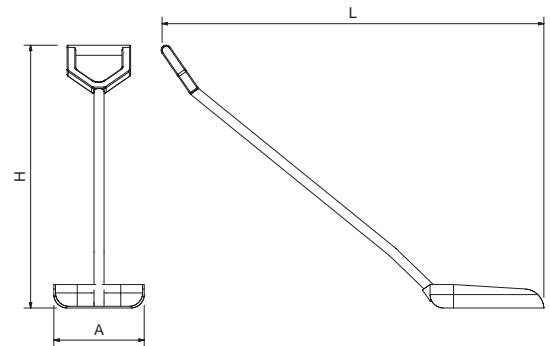

L	A	H	Gr	Barcode	€
890	265	660	500	474458	75,00

Pala de mano para hielo

Ice shovel
Pelle à glaçons



Characteristics:

It is made of polypropylene, which guarantees:
No water absorption.
No loss of hardness in humidity conditions.
Possibility of sterilization.
It resists temperatures up to 100°C.

Caractéristiques:

Sa fabrication en polypropylène garantit:
Pas d'absorption d'eau.
Pas de perte de dureté dans conditions d'humidité.
Possibilité de stérilisation.
Supporte température jusqu'à 100°C.

Características:

Su fabricación en polipropileno garantiza:
No absorbe agua.
No pierde su dureza en condiciones de humedad.
Puede ser esterilizado (no en autoclave).
Soporta temperaturas de hasta 100°C.

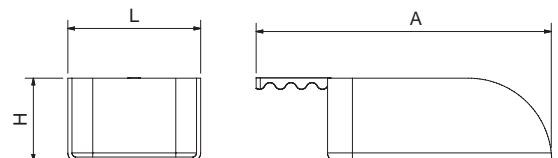

L	A	H	Gr	Barcode	€
160	340	90	150	474456	18,00

Módulo expositor de frutas y verduras

Display counter for fruits and vegetables
Module d'exposition pour fruits et légumes

Este innovador sistema modular de exposición de frutas le permitirá crear un área de venta a su medida. Moderna, atractiva y eficaz, se integrará con el resto de su mobiliario. Compacta, móvil y flexible. Cuando no se usa se puede plegar ocupando un espacio mínimo de almacenamiento. Superficie de presentación plana y semi-inclinada.



This innovative modular fruit display system will allow you to create a customized sales area. Modern, attractive and effective, it will be integrated with the rest of your furniture. Compact, mobile and flexible. It can be folded to save up space of storage when not used. Surface for presentation flat or semi-inclined.



Ce système innovateur modulaire d'exposition de fruits, vous permettra de créer une zone de vente à votre mesure. Moderne, attrayante et efficace, il s'intégrera avec le reste du mobilier. Compacte, mobile et flexible. Quand il ne s'emploie pas peut se plier en occupant un espace minimum de stockage. Une surface de présentation plate et semi-inclinée.

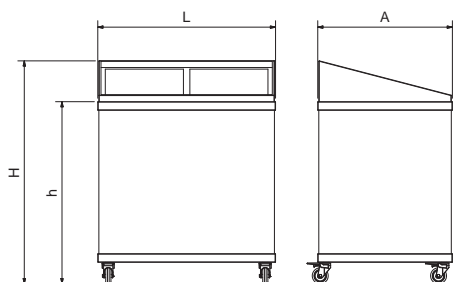

Op Opcional / Optional / Optionnel

L	A	H	h	Kg	Kg	Barcode	€
815	615	1.045	845	80	6	475620	250,00

Novedad
New
nouveau



Características:

Ruedas \varnothing 75 mm. de goma con freno.
Adhesivo digital efecto madera.
Carga máxima 80 kilos.



Characteristics:

Rubber wheels \varnothing 75 mm with brake.
Sticker with digital wood effect.
Maximum load 80 kg.

Caractéristiques:

Roues \varnothing 75 mm. caoutchouc avec frein.
Autocollant digital effet bois.
Charge maximale 80 kilos.



Mostrador frutería

Floor-mounted vegetable counter
Comptoir fruits et légumes

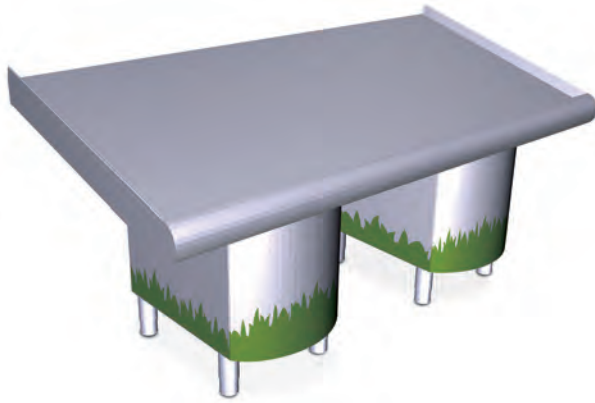

Tacos regulables
Desagües
Mangueras desagües
Puertas desmontables
Juego de adhesivos hierba para los frentes

Adjustable blocks
Drainers
Drains hoses
Rear detachable doors
Set of decorative stickers "Hierba"

Taquets réglables
Déversoirs
Tuyaus déversoirs
Portes postérieures amovibles
Jeu d'autocollants décoratives

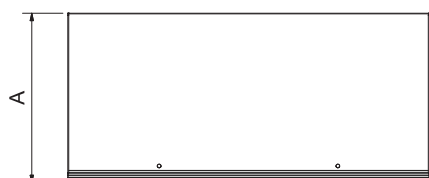
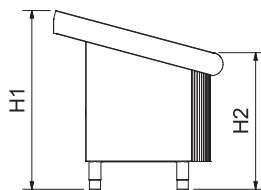
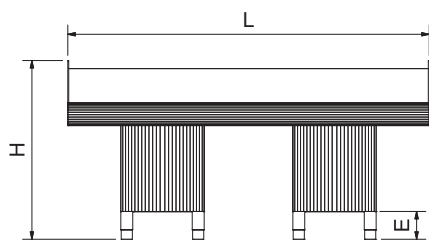
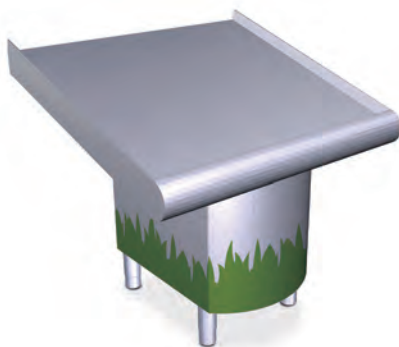

Características:

Fabricado totalmente con acero inoxidable AISI 304, está diseñado para adaptarse a las necesidades de los diferentes establecimientos.

Characteristics:

Wholly made of stainless steel AISI 304, it has been designed to meet the needs of any establishment.

Caractéristiques:

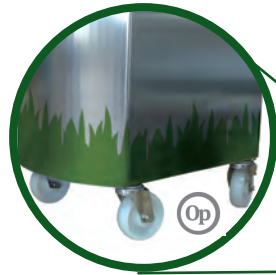

Fabriqué totalement en acier inoxydable AISI 304, c'est conçu pour subvenir les besoins de tous les établissements.



Mediante la regulación de los pies podemos incrementar la altura hasta 50 mm más.

By the adjustment of the legs you can increase the height up to 50 mm.

Par le réglage des pieds vous pouvez incrémenter l'hauteur jusqu'à 50 mm.

L	A	H	H1	H2	E		Kg		€
985	950	1.045	960	730	150	1	39,0	075630	1.150,00
1465	950	1.045	960	730	150	2	69,0	075632	1.500,00
1948	950	1.045	960	730	150	2	76,5	075634	1.880,00
2911	950	1.045	960	730	150	2	90,5	075636	2.400,00

Mostrador frutería sobre obra

Vegetable counter to be fitted on a built-in stand
Comptoir fruits et légumes de chantier

Características:

Fabricado totalmente con acero inoxidable AISI 304, está diseñado para adaptarse a las necesidades de los diferentes establecimientos.

Characteristics:

Wholly made of stainless steel AISI 304, it has been designed to meet the needs of any establishment.

Caractéristiques:

Fabriqué totalement en acier inoxydable AISI 304, c'est conçu pour subvenir les besoins de tous les établissements.

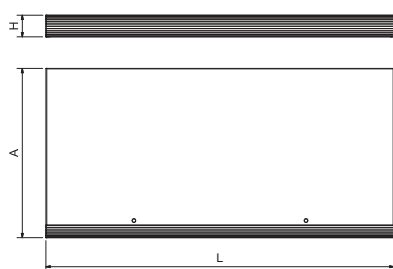
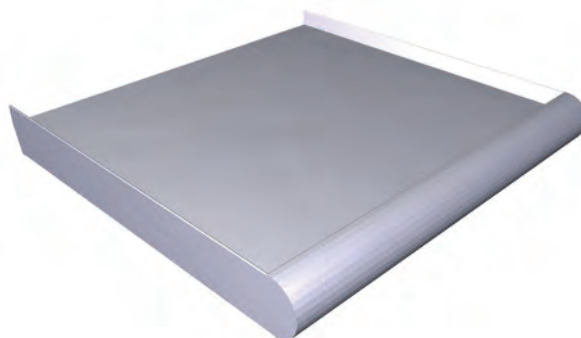

Tacos regulables
Desagües
Mangueras desagües

Adjustable blocks
Drainers
Drains hoses

Taquets réglables
Déversoirs
Tuyaus déversoirs

L	A	H	Kg	Barcode	€
985	950	120	16	075620	550,00
1465	950	120	23	075622	700,00
1948	950	120	30	075624	850,00
2911	950	120	44	075626	1.350,00

Separador para mostrador de frutería / pescadería

Divider for vegetable / fish counter
Séparateur pour comptoir de Fruiterie /Poissonnerie

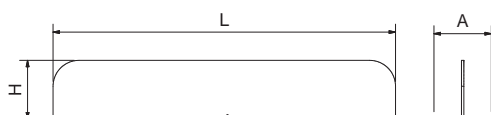
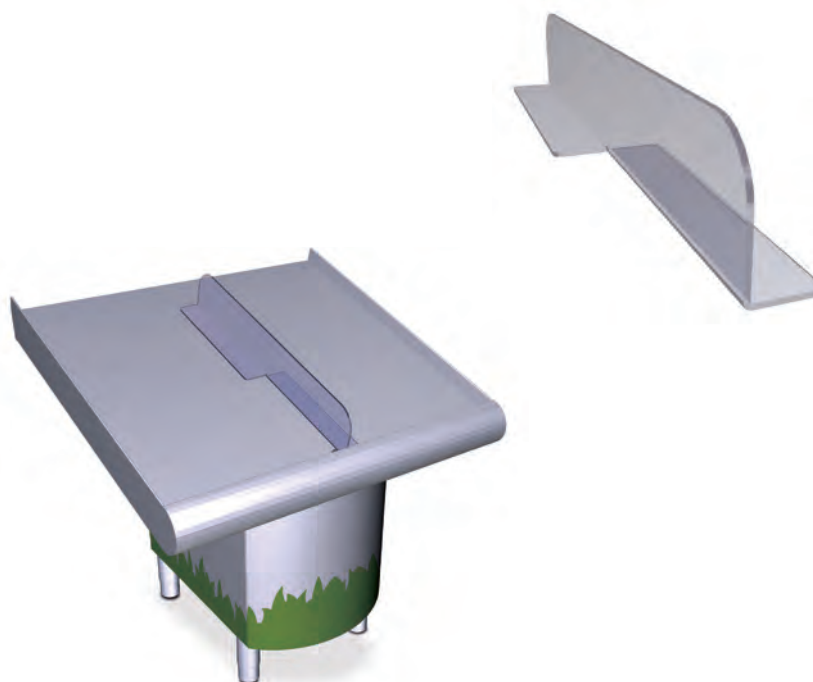

L	A	H	Kg	Barcode	€
860	144	147	1,7	075638	78,00



075636



2.400,00



328



Mostrador frutería
Floor-mounted vegetable counter
Comptoir fruits et légumes

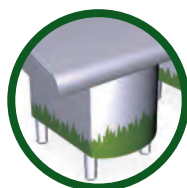

074462



1.155,00



319



Prolongación modular
Modular extension
Extension modulaire

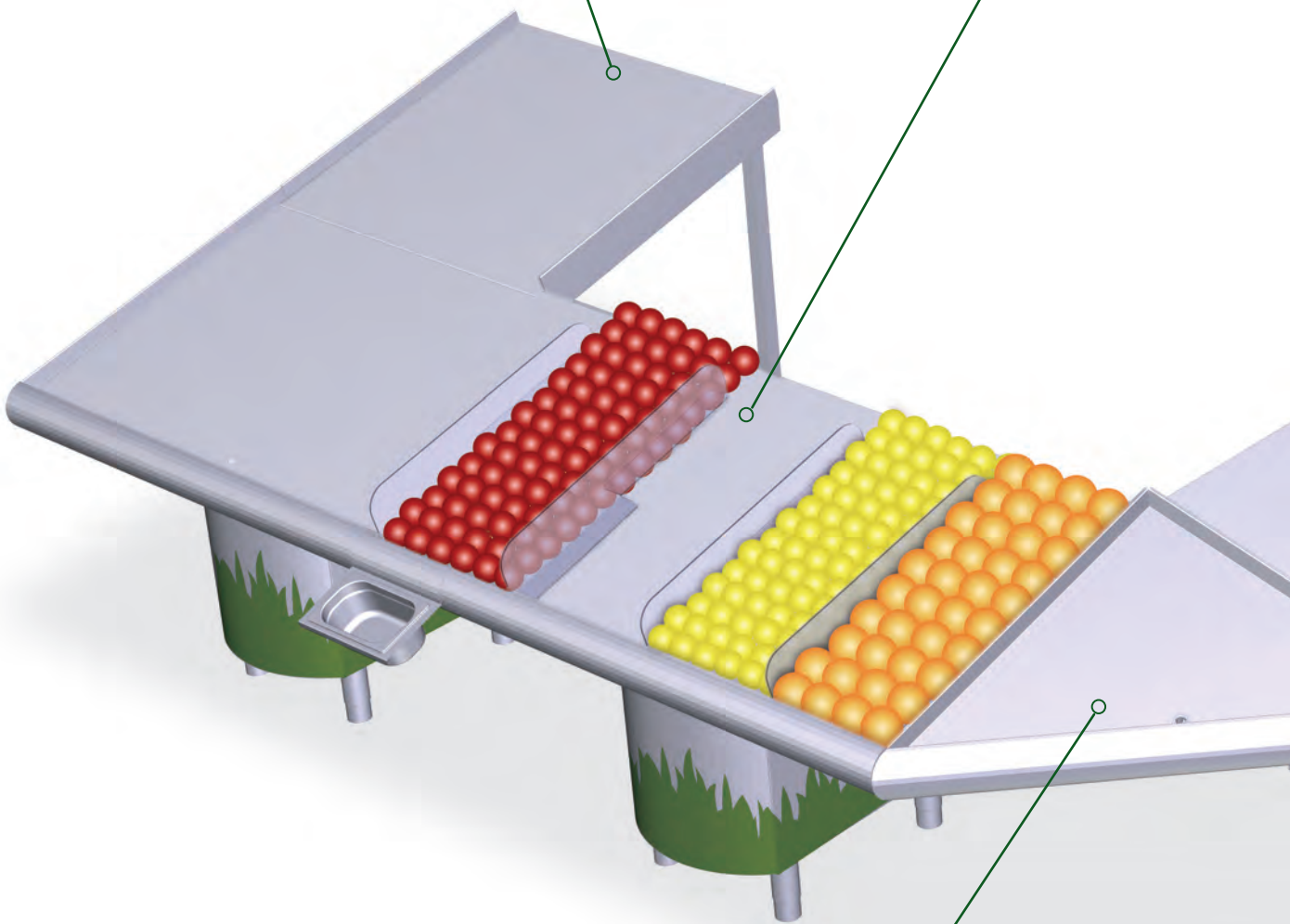

Unión en escuadra exterior
Fish counter external corner link
Jonction d'angle pour étal à poisson

L	A	H	Kg	Barcode	€
1.290	960	256	11,00	074448	495,00

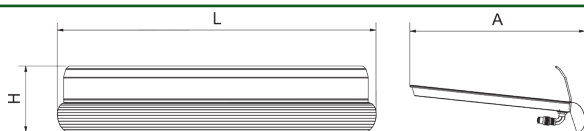
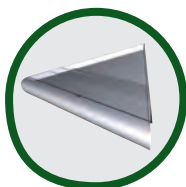



483012



14,00



427



Cestas alimentarias
Food baskets
Paniers alimentaires



Unión en escuadra interior
Internal-corner link
Jonction d'angle interne

L	A	H	Kg	Barcode	€
1.230	870	118	8,00	074449	330,00

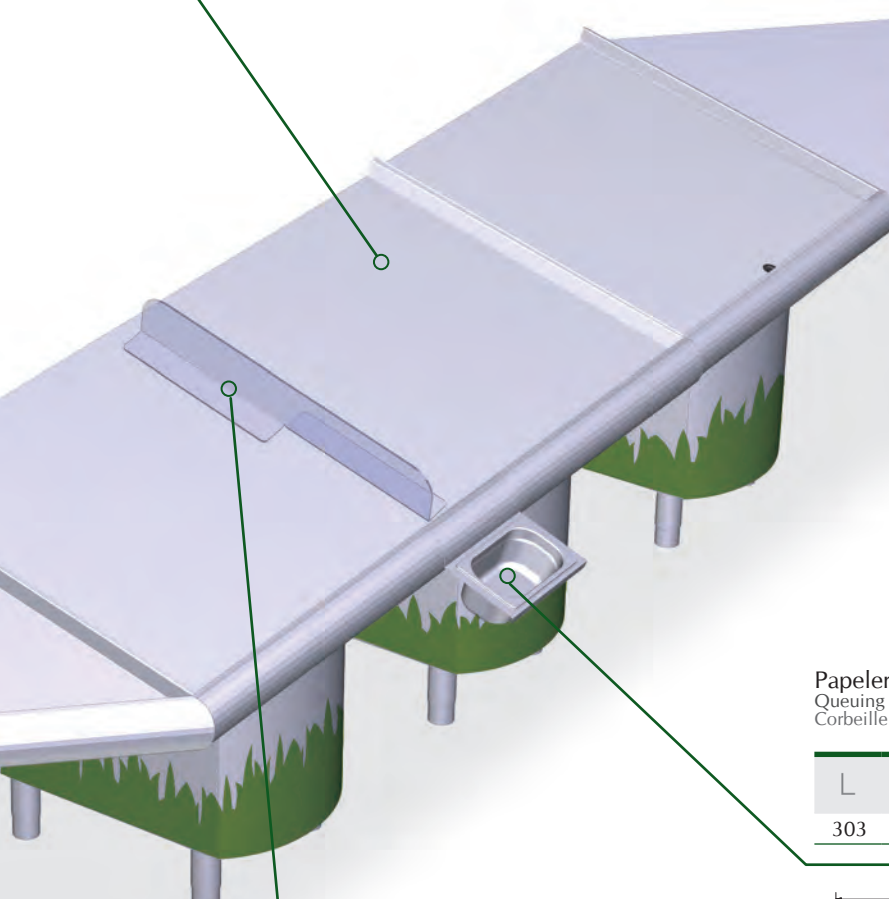
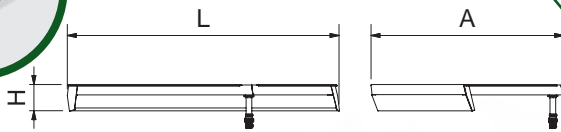
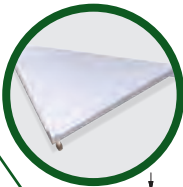

Papelera su turno para mostrador
Queuing wastepaper bin for displays
Corbeille à papier à file d'attente pour étal

L	A	H	Kg	Barcode	€
303	260	148	1,40	074466	55,00

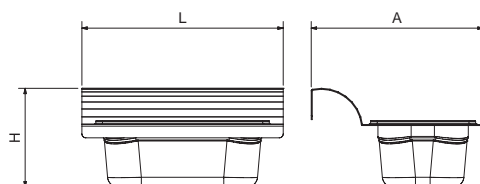
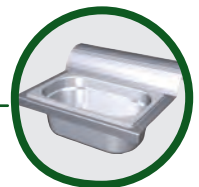

075638



78,00



329



Separador para mostrador de frutería / pescadería
Divider for vegetable / fish counter
Séparateur pour comptoir de Fruiterie /Poissonnerie

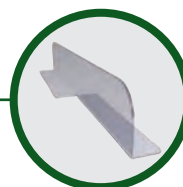

Taquillas de 1, 2 y 3 puertas

1, 2 and 3 doors lockers

Armoire pour vestiaire de 1, 2 et 3 portes



Características:

Construida totalmente en acero inoxidable, acabado satinado. Dispone de techo inclinado y patas en altura de 115 mm para poder limpiar debajo de ella. Estas patas están situadas de manera que salvan la curva sanitaria en la pared. Pies regulables. Ventilación mediante respiraderos embutidos. Cerraduras independientes. Cada cuerpo lleva un entrepaño superior, otro en la base y un perchero.

Characteristics:

Totally made in stainless steel, satin finished, they have inclined roof, legs' high 115 mm. To be able to clean under them, also these legs are situated to save the sanitary curve in walls, regulable feet, ventilation by inlay breathings, and individual locks. Every section has a lower and an upper shelf and a clothes rack.

Caractéristiques:

Fait totalement en acier inox, finition satiné, ils ont le toit incliné, pieds en hauteur de 115 mm. Pour pouvoir nettoyer par dessous d'eux, aussi ces pieds sont situés pour qu'ils sauvent la courbe sanitaire dans le mur, pieds réglables, ventilation par soupiraills encastrés, et fermeture indépendant. Chaque section a un évier supérieur et inférieur et un portemanteau.

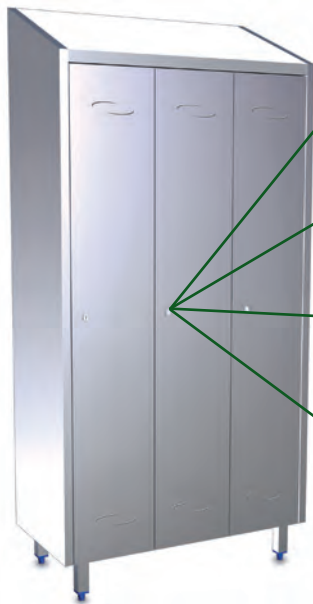

€ 50,00 335

Cerradura de retorno de monedas
Coin operated lock
Serrure à monnaies

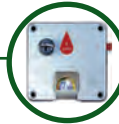

481402 € 3,00 335

Llave maestra para cerraduras.
Master key for locks
Clé passe-partout pour serrures



081612 € 240,00

Opción de kit de ozono acoplado.
Optional ozone kit coupled
kit ozone accouplé

€ 77,00 336

Cerradura electrónica para taquilla
Electronic lock for lockers
Serrure électronique pour la porte vestiaire

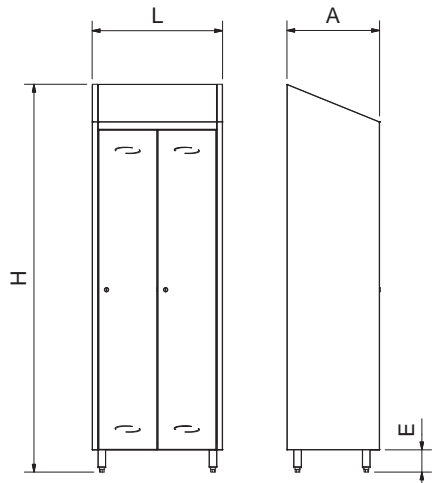

Contienen dos perchas inox por puerta.
Two inox hangers for each door included.
Deux cintres inox inclus par chaque porte.



Posibilidad de acoplar ruedas ver pág 467
Possibility of assembly wheels, see page 467
Possibilité d'accoupler rouelles, voir page 319

L	A	H	E				€
370	480	2.010	115	1	27	081412	625,00
680	480	2.010	115	2	49	081406	895,00
985	480	2.010	115	3	62	081408	1.200,00



Consulten la posibilidad de acoplar un desinfectador-desodorizador por ozono en las taquillas.
Ask for the possibility of assembly a disinfectant-deodorant by ozone in the locker.
Demandez-nous sur la possibilité de accoupler un désinfectant-désodorisant à l'ozone dans l'armoire.

Taquillas de 2, 4 y 6 puertas

2, 4 and 6 doors lockers

Armoire pour vestiaire de 2, 4 et 6 portes

Características:

Construida totalmente en acero inoxidable, acabado satinado. Dispone de techo inclinado y patas en altura de 115 mm para poder limpiar debajo de ella. Estas patas están situadas de manera que salvan la curva sanitaria en la pared. Pies regulables. Ventilación mediante respiraderos embutidos. Cerraduras independientes. Cada cuerpo lleva un entrepaño superior, otro en la base y un perchero.



Characteristics:

Totally made in stainless steel, satin finished, they have inclined roof, legs' high 115 mm. To be able to clean under them, also these legs are situated to save the sanitary curve in walls, regulable feet, ventilation by inlay breathings, and individual locks. Every section has a lower and an upper shelf and a clothes rack.

Caractéristiques:

Fait totalement en acier inox, finition satiné, ils ont le toit incliné, pieds en hauteur de 115 mm. Pour pouvoir nettoyer par dessous d'eux, aussi ces pieds sont situés pour qu'ils sauvent la courbe sanitaire dans le mur, pieds réglables, ventilation par soupirlais encastrés, et fermeture indépendante. Chaque section a un évier supérieur et inférieur et un portemanteau.



€ 50,00 335 Op

Cerradura de retorno de monedas
Coin operated lock
Serrure à monnaies



481402 3,00 335 Op

Llave maestra para cerraduras.
Master key for locks
Clé passe-partout pour serrures

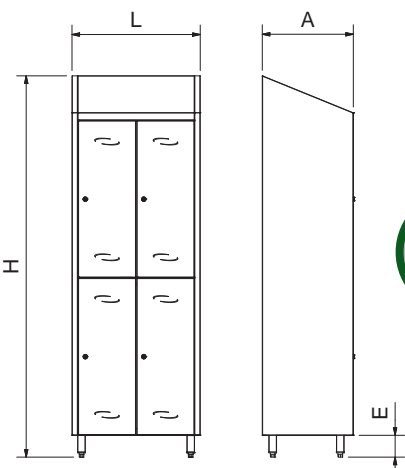

081612 240,00 Op

Opción de kit de ozono acoplado.
Optional ozone kit coupled
kit ozone accouplé

€ 77,00 336 Op

Cerradura electrónica para taquilla
Electronic lock for lockers
Serrure électronique pour la porte vestiaire



Posibilidad de acoplar ruedas ver pág 467
Possibility of assembly wheels, see page 467
Possibilité d'accoupler rouelles, voir page 467



Contienen dos perchas inox por puerta.
Two inox hangers for each door included.
Deux cintres inox inclus par chaque porte.

L	A	H	E				€
370	480	2.010	115	2	28	081410	695,00
680	480	2.010	115	4	50	081402	990,00
985	480	2.010	115	6	68	081404	1.380,00



Consulten la posibilidad de acoplar un desinfectador-desodorizador por ozono en las taquillas.
Ask for the possibility of assembly a disinfectant-deodorant by ozone in the locker.
Demandez-nous sur la possibilité de accoupler un désinfectant-désodorisant à l'ozone dans l'armoire.

Percha industrial de acero inoxidable

Stainless steel industrial hanger
Cintre industrielle en acier inoxydable

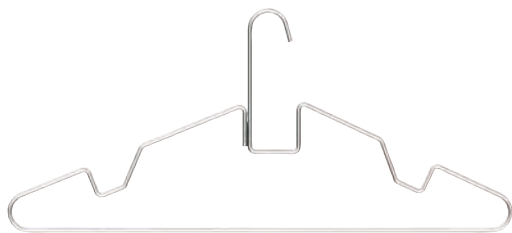

Características:

Totalmente construida en acero inoxidable.
Ideal para gimnasios, piscinas, vestuarios colectivos, lavanderías, etc.
Diseño renovado que permite colgar delantales y prendas con tirantes.

Characteristics:

Wholly made of stainless steel.
Excellent for gymnasiums, swimming pools, dressing-rooms, laundries, etc.
New design that allows to hang up aprons and garments with shoulder straps.

Caractéristiques:

Entièrement construit en acier inoxydable.
Excellente pour gymnases, piscines, établissements de bains, blanchisseries, etc.
Dessin renouvelé qui permet prendre des tabliers et vêtements à épaulettes.

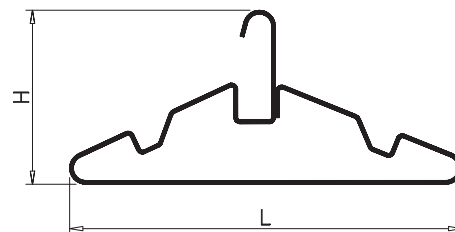

L	H	Gr	Barcode	€
420	190	120	081450	10,00

Separadores para taquillas

Dividers for lockers
Diviseur pour armoire vestiaire

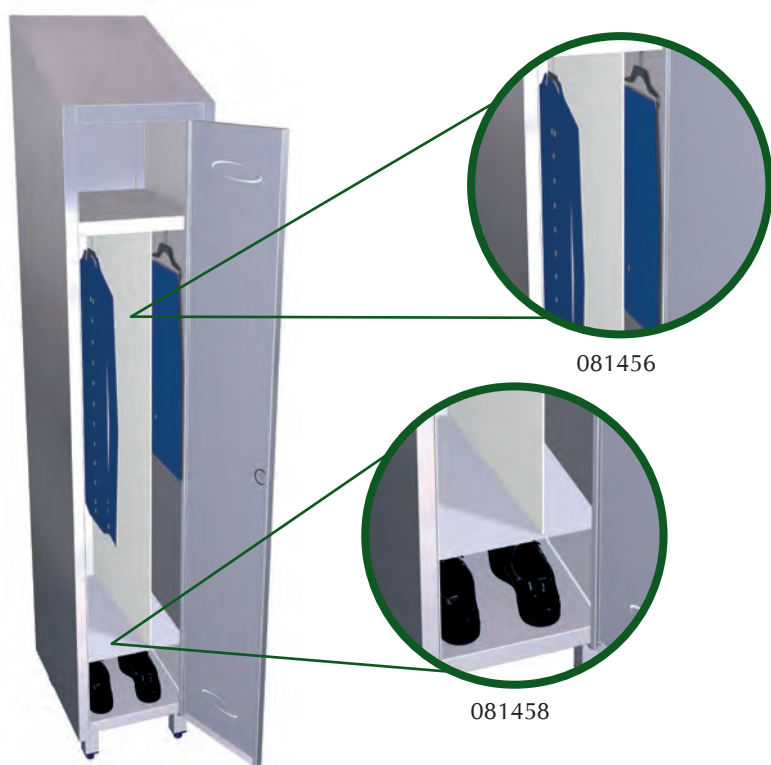

081456

081458

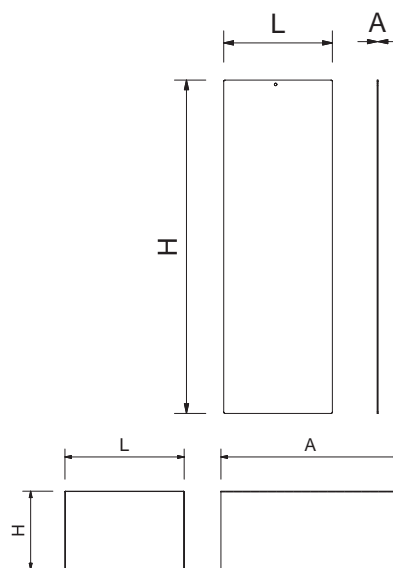

L	A	H	Kg	Barcode	€
450	3	1.180	0,80	081456	22,00
300	450	197	2,03	081458	29,00

Banco vestuario

Changing room bench
Banc pour vestiaire

Características:

Estructura de acero inoxidable.
Asiento de fenólico en lamas color azul.
Cantos redondeados.
Tornillos ocultos en inoxidable.

Characteristics:

Structure manufactured in stainless steel.
Seat of phenol lames of blue colour.
Rounded edge.
Hidden screws in stainless steel.

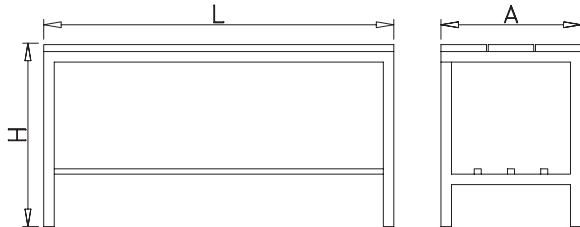

Caractéristiques:

Structure construit en acier inoxydable.
Siège en phénol de lames couleur bleu.
Rebord ronde.
Vis occultes en acier inoxydable.

L	A	H	Kg	Barcode	€
1.000	340	480	12,0	481602	325,00
1.500	340	480	18,0	481604	495,00

Banco inoxidable de vestuario con doble zapatero

Stainless bench for changing room with double shoe rack
Banc range chaussures inoxydable de vestiaire 2 niveaux

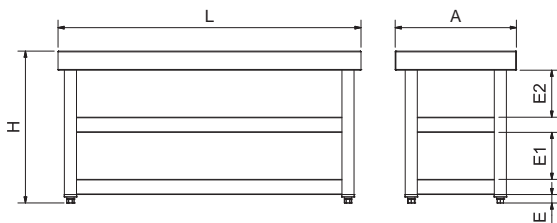

L	A	H	E	E1	E2	Kg	Barcode	€
1.000	400	500	28	155	155	18,7	084202	490,00

Repuestos y complementos

Spare part and complements
Rechange et compléments



Cerradura
Lock
Serrure

Gr Barcode €

41 481404 5,00



Cerradura maestra
Master lock
Serrure master

481405 8,00



Llave maestra para cerraduras
Master key for locks
Clé passe-partout pour serrures

10 481402 3,00



Cerradura de retorno de monedas
Coin operated lock
Serrure à monnaies











790 481410 50,00
481412

Montaje de la cerradura de retorno de monedas (no incluye cerradura)
Assembly coin operated lock (lock not included in this price)
Assembler serrure à monnaies (serrure n'inclus pas dans ce prix)

081452 30,00

Repuestos y complementos

Spare part and complements
Rechange et compléments

		Gr	Barcode	€
	Pomo articulado Articulated handle Poignée articulée	80	481406	6,50
	Candado para pomo articulado Padlock for articulated handle Cadenas poignée articulée	105	481408	22,00
	Juego de herrajes para puertas (para 2 puertas) Sliding doors fixtures set (valid for two doors) Set de ferrures pour portes coulissantes (valide pour deux portes)	85	073850	63,00
	Taco regulable Adjustable blocks Taquets réglables	45	409851	1,34
	Taco regulable altura especial Special height adjustable blocks Taquets réglables hauteur spéciale	115	409848	2,75
	Tirador para puerta abatible Handle for hinged door Poignet pour porte battante	80	474050	6,00
	Cierre de clip de bolas Roller bracket closing Fermeture à rouleau	40	474052	4,50
	Juego de llaveros numerados del 1 al 6 Set of keyrings, numbered from 1 to 6 Ensemble de porte-clés numérotés de 1 à 6	30	481438	9,00
	Juego de placas numeradas del 1 al 6 Set of plates, numbered from 1 to 6 Ensemble de plaques numérotées de 1 à 6	20	481439	6,50
	Cerradura con cadena para consigna de carros Locker with chain for left-shopping trolleys Serrure avec chaîne pour consigne pour caddies	850	481430	63,00
	Cerradura electrónica para taquilla Electronic lock for lockers Serrure électronique pour la porte vestiaire	584	➔ 481418	77,00
			➔ 481419	
	Montaje cerradura electrónica en puerta de taquilla (no incluye cerradura) Installation of electronic lock for lockers (lock not included) Montage serrure électronique sur porte de vestiaire (la serrure n'est pas incluse)		081454	30,00

Campana extractora mural acero inoxidable

Wall-mounted stainless steel exhaust hood
Hotte de cuisine murale en acier inoxydable

Características:

Construidas en acero inoxidable.
Sin motor.
Bandeja recoge-grasas con válvula de desengrase.
Filtros inoxidables de 490x490x50 mm.



Characteristics:

Fabricated in stainless steel.
Extractor fan motor not included.
Grease tray with valve for evacuation.
Stainless steel filters 490x490x50 mm.

Caractéristiques:

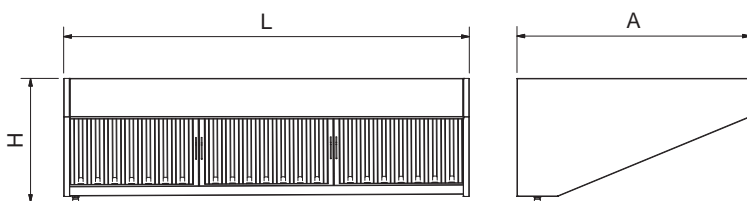
Fabriquées en acier inoxydable.
Sans moteur.
Bac de récupération des graisses avec vanne de dégraissage.
Filtres inoxydables 490x490x50 mm.



L	A	H				€
987	850	452	2	18,30	076602	440,00
1.477	850	452	3	24,40	076604	482,00
1.968	850	452	4	31,60	076606	550,00

Filtro inoxidable para campana extractora industrial

Stainless steel filter for commercial exhaust hood
Filtre inox pour hotte de cuisine industrielle



L	A	H			€
490	490	50	2,05	476702	24,00



SEGURIDAD E HIGIENE

Health and care
Sécurité et santé au travail

NOVEDADES

News
Nouveautés

Guante de vinilo azul desechable Disposable blue vinyl glove Gant de vinyle bleu jetable.....	344	Cepillo de barrer suave antiestático Antistatic sweeping brush with soft bristles Brosse à balai antistatique doux	388
Registador de temperatura y humedad Temperature and humidity recorder Enregistreur de température et humidité..	351	Cepillo antiestático estrecho para maquinaria Narrow antistatic brush for machinery Brosse antistatique étroite pour machines	389
Reactivo líquido para check cloro Liquid reagents for chlorine check Réactifs liquides pour la vérification du chlore.....	352	Pala antiestática de mano Antistatic hand shovel Pelle antistatique de main	389
Adaptador enchufe tipo H Type H plug adapter Adaptateur pour prise électrique type H..	367	Recogedor de mano inox Long handle stainless dustpan Peel inoxydable avec manche	389
Papelera con tapa y ruedas 70 lt Container with lid and wheels 70 l. Poubelle avec couvercle et roulettes 70 lt	371	Recogedor inox Stainless dustpan Peel inoxydable	389
Papelera de reciclaje con tapa basculante Recycling bin with swing lid Poubelle de recyclage avec couvercle basculant	375	Recogedor abatible antiestático con mango una pieza Antistatic dustpan with foldable handle, one piece Pelle à ramasser rabattable antistatique avec manche une pièce	390
Cubo pedal baño con papelera interior Pedal bin Poubelle sale de bains	377	Cubo antiestático Antistatic bucket Seau antistatique.....	390
Lavaojos mural de emergencia en acero inoxidable Stainless steel wall-mounted emergency eyes-bath Lave-yeux mural d'urgence en acier inoxydable	386	Barreños Food tubs Baquets ronds aliments.....	391
Ducha mural de emergencia Wall-mounted emergency shower Douche d'urgence murale	386	Tapa para barreños Food tubs lid Couvercle pour bassine	391
Espátula de plástico antiestático Antistatic plastic spatula Spatule en plastique antistatique	388	Plato ducha inox Inox shower tray Plateaux douche inox	394
Rasqueta antiestática flexible para masa sin agujero Antistatic flexible dough scraper without hole Grattoir antistatique flexible pour surface sans trous	388	Plato ducha lacado Lacquer shower tray Plateaux douche laqués.....	394
		Secamanos inox con pulsador y tobera Stainless push-button operated hand dryer with nozzle Sèche-mains inox avec poussoir et tuyère	399
		Dispensador automático de toallas Automatic towel dispenser Distributeur automatique de serviettes ...	404





Guantes de cinco dedos ambidiestro en malla de acero inoxidable

Reversible five finger stainless-steel mesh gloves
Gants à cinq doigts réversibles en maille d'acier inoxydable

Características:

Guante construido en acero inoxidable.
Guante antibacteriano para una higiene perfecta, reforzada gracias a su facilidad de limpieza.
Mayor protección. Seguridad total, ya que carece de escotadura. Garantiza una protección total de la mano contra los cuchillos más afilados.
Mayor confort de uso.

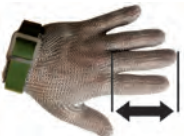
Talla Size Taille	XXS	XS	S	M	L
	≤72	73-78	79-83	84-88	≥89



EXPERT



Characteristics:

Glove wholly made in stainless steel.
Anti-bacteria glove for a perfect hygiene, reinforced thanks to its cleaning easiness.
Higher protection. Total security, since it lacks low sleeve-line. It guarantees a total hand protection against the sharpest knives.
Higher usage comfort.



Talla Size Taille	Gr		€	Gr		€	Gr		€
			EXPERT						
XXS	130	448600	100,00	130	448610	115,00	200	448650	150,00
XS	140	448602	100,00	140	448612	115,00	235	448652	150,00
S	150	448604	100,00	150	448614	115,00	270	448654	150,00
M	170	448606	100,00	170	448616	115,00	305	448656	150,00
L	185	448608	100,00	185	448618	115,00	340	448658	150,00

Caractéristiques:

Gant entièrement fabriqué en acier inoxydable.
Gant anti-bactérienne pour une hygiène parfaite renforcée grâce à la facilité de sa nettoyage.
Plus grande protection. Sécurité totale puisqu'il n'y a pas de échancrure. Il garantit une protection totale de la mine contre les couteaux, même les plus aiguisés.
Plus grande confort d'usage.

Tensor para guantes malla

Tensor for stainless-steel mesh gloves
Tenseur des gants maille d'acier inoxydable



Talla Size Taille	Gr	€	Gr	€
Única Universal Unique	800	100	448620	30,00

Delantal anti salpicaduras

Splash apron
Tablier de protection pour les éclaboussures

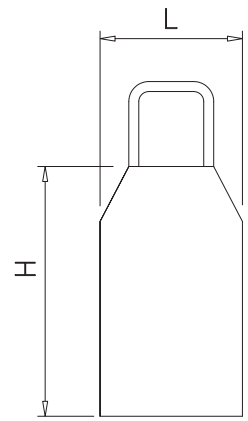

L	H	Gr	Barcode	€
600	1.000	500	448806	138,00

Delantal de protección en malla de acero inoxidable

Stainless steel mesh protective apron
Tablier de protection en maille d'acier inoxydable



DIN en ISO 13998:2003
DIN en ISO 13998:2003
DIN en ISO 13998:2003

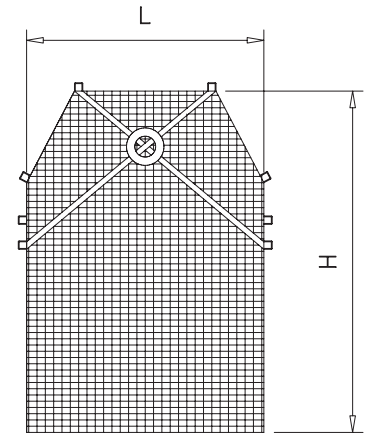

L	H	Kg	Barcode	€
550	800	1,15	448802	157,00

Delantal de escay

Faux leather apron
Tablier en skay

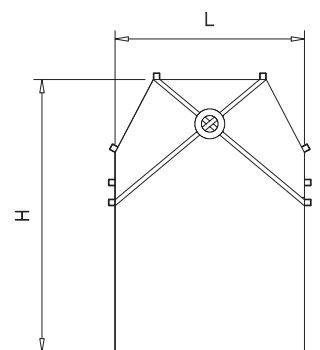

L	H	Gr	Barcode	€
700	1.100	600	448804	16,00

Guante alimentario anticorte

Anti-cut food glove
Gant alimentaire anti-coupure



Características:

Guante anticorte para el contacto directo con los alimentos. Lavable más de 100 veces sin degradación.

Generalmente se usa para llevarlo en la mano que manipula el cuchillo, siendo la mano contraria la que utiliza el guante de malla de acero inoxidable.

Ambidiestro.

Characteristics:

Glove anti-cut for a direct contact with food. Washable more than 100 times without degradation.

It generally is worn on the hand that handle the knife, whereas the stainless steel mesh glove is put on the other hand. Ambidextrous.

Caractéristiques:

Gant anti-coupure pour le contact direct avec les aliments. Lavable plus de 100 fois sans dégradation.

Généralement est utilisé pour le porter dans la main avec laquelle on utilise le couteau, tandis que la main contraire porte le gant de maille en acier inoxydable. Ambidextre.

Tamaño Size Dimension	Gr	Barcode	€
≤70	S	100 448670	51,00
71-80	M	110 448672	51,00
81-100	L	115 448674	51,00
≥101	XL	120 448676	51,00



El precio es por pareja.
The pair is included in the price.
Le paire est inclus dans de prix.

Guante para pescadero

Glove for fishmongers
Gant pour poissonniers



Características:

Excelente protección en las industrias de pesca y viticultura.

Resistente a los cortes.

Látex natural crépé.

Recubrimiento sobre soporte de algodón afelpado.

Longitud 300 mm.

Characteristics:

Excellent protection for fishing and viticulture industry.

Cut-resistant.

Natural laminated latex.

Coverage on cotton towel.

Length 300 mm.

Caractéristiques:

Excellent protection pour les industries de la pêche et la viticulture.

Résistant aux coupures.

Crépé en latex naturel.

Recouvrement sur coton pelucheux.

Longueur 300 mm.

Talla Size Taille	Gr	Barcode	€
Única Universal Unique	250	448668	12,80



El precio es por pareja.
The pair is included in the price.
Le paire est inclus dans de prix.

Guante anti-salpicaduras aceite hirviendo

Boiling oil anti-splashing glove
Gant anti-éclaboussures d'huile bouillant



Características:

Guante en piel con recubrimiento de kevlar aluminizado en el dorso.

Characteristics:

Glove in leather covered with Kevlar-aluminium in the back.

Caractéristiques:

Gant en cuir avec recouvrement en Kevlar-aluminium dans le dos.

Talla Size Taille	Gr	Barcode	€
Única Universal Unique	400	448682	53,00



El precio es por pareja.
The pair is included in the price.
Le paire est inclus dans de prix.

Guante anticalórico hasta 150 °C

Anti-caloric glove up to 150 °C
Gant anti-calorique jusqu'à 150 °C



Características:

Guante anticalórico de punto mixto algodón/poliéster para la manipulación de piezas calientes hasta 150 °C. Puño de punto de 60 mm.

Characteristics:

Anti-caloric glove in mixed stitch cotton/polyester for the handling of hot pieces up to 150°C. Cuff in stitch of 60 mm.

Caractéristiques:

Gant anti-calorique en point mixte coton/polyester pour la manipulation des pièces chauds jusqu'à 150 °C. Poignet en point de 60 mm.

Talla Size Taille	Gr	Barcode	€
Única Universal Unique	120	448678	5,00



El precio es por pareja.
The pair is included in the price.
Le paire est inclus dans de prix.

Manopla anticalórica hasta 350 °C

Anti-caloric oven glove up to 350 °C
Moufle anti-calorique jusqu'à 350 °C



Caractéristiques:

Moufle en coton de boucle première qualité (1000 g/m²) pour la manipulation des pièces chaudes jusqu'à 350°C. Pourvu de doublure de pull-over et para-vapeur inséré entre les boucles et le pull-over.

Características:

Manopla de algodón de rizo de calidad superior (1.000 g/m²), para manipulación de piezas calientes hasta 350° C. Provista de forro de jersey y paravapor insertado entre el rizo y el jersey.

Characteristics:

Oven glove in high quality cotton boucle of 1000 g/m² for the handle of hot pieces up to 350°C. Provided with pull-over lining and anti-steam inserted between the boucles and the pull-over.



El precio es por pareja.
The pair is included in the price.
Le paire est inclus dans de prix.

Talla Size Taille	Gr		€
Única Universal Unique	440	448680	19,00

Guantes para frío extremo en PVC hasta -20° C

Gloves for extreme cold in PVC - temperatures below -20° C
Gants pour froid extrême en PVC - températures inférieures à -20° C



Características:

Fabricado en PVC con forro interior en lana.

Characteristics:

Made in PVC lined with wool.

Caractéristiques:

Fabriqué en PVC avec doublure en laine.



El precio es por pareja.
The pair is included in the price.
Le paire est inclus dans de prix.

Talla Size Taille	Gr		€
Única Universal Unique	420	448690	17,00

Guantes para frío extremo en piel hasta -20 °C

Gloves for extreme cold in leather – temperatures below -20 °C
Gants pour froid extrême en cuir – températures inférieures à -20 °C



Características:

Fabricado en piel de vacuno hidrofugada con interior en fibra de Thinsulate.

Caractéristiques:

Fabriqué en cuir de bovine hydrofuge avec l'intérieur en fibre Thinsulate.

Characteristics:

Made in damp-proof cow leather lined with Thinsulate fibre.



El precio es por pareja.
The pair is included in the price.
Le paire est inclus dans de prix.

Talla Size Taille	Gr		€
Única Universal Unique	380	448692	13,00

Guante de vinilo azul desechable

Disposable blue vinyl glove
Gant de vinyle bleu jetable



Características:

Gran sensibilidad táctil.
Vinilo muy alta calidad.
No produce alergias.
Válido para industria alimentaria.

Characteristics:

High tactile sensitivity.
Very high quality vinyl.
Hypoallergenic.
Specifically for food industry.

Caractéristiques:

Grande sensibilité tactile.
Vinyle de très haute qualité.
Ne produit pas d'allergies.
Valable pour l'industrie alimentaire.

Unidades por caja
Box units
Unités par boîte

Talla Size Taille		Gr		€
Única Universal Unique	100	5,5	448694	11,00

Talla Size Taille	Gr	Barcode	€
Única Universal Unique	40	448684	4,00



El precio es por pareja.
The pair is included in the price.
Le paire est inclus dans de prix.

Guante anticorte industrial

Anti-cut industrial glove
Gant anti-coupure industriel



Guante de piel industrial

Leather industrial glove
Gant industriel en cuir



Talla Size Taille	Gr	Barcode	€
Única Universal Unique	120	448686	7,00



El precio es por pareja.
The pair is included in the price.
Le paire est inclus dans de prix.

Guante de protección química

Chemical protective glove
Gant de protection chimique



Talla Size Taille	Gr	Barcode	€
Única Universal Unique	116	448688	3,70



El precio es por pareja.
The pair is included in the price.
Le paire est inclus dans de prix.

Guantes de nitrilo para uso alimentario

Nitrile gloves for food use
Gants en nitrile pour usage alimentaire



L	Gr	Barcode	€
380	195	448666	12,00



El precio es por pareja.
The pair is included in the price.
Le paire est inclus dans de prix.

Gafas antiproyecciones

Protective glasses
Lunettes de protection



Características:

Gafa panorámica unilente de policarbonato, compatible con gafas graduadas.

Characteristics:

Single lens polycarbonate goggle compatible with prescription glasses.

Caractéristiques:

Lunettes-masques en polycarbonate à une seule verre, compatibles avec des lunettes de vue.

Gr		€
150	448830	3,00

Pantalla antiproyecciones

Protective mask
Masque de protection



Gr		€
180	448834	12,00

Protector auditivo

Ear protection
Protecteur de l'oreille



Características:

Protector auditivo ergonómico de alto confort.
Atenuación alta. SNR: 30dB.
Almohadilla en el arnés.

Characteristics:

Ergonomic hearing protector with superior comfort
High noise attenuation, SNR 30dB
Padded headband.

Caractéristiques:

Protection auditive ergonomique avec un confort supérieur
Atténuation du bruit, SNR 30dB
Arceau rembourré.

Gr		€
250	448832	19,80

Botas de agua PVC/Nitrilo

Waterproof boots in PVC/Nitrile
Bottes pluie en PVC / Nitrile



Talla Size Taille	Gr		€
38	1.568	448850	28,00
39	1.602	448852	28,00
40	1.676	448854	28,00
41	1.786	448856	28,00
42	1.852	448858	28,00
43	2.002	448860	28,00
44	2.098	448862	28,00

Termómetro digital básico

Basic digital thermometer
Thermomètre digital basic

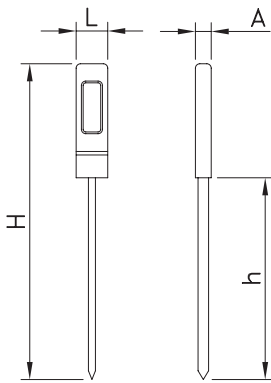

L	A	H	h	Gr	Barcode	€
20	20	195	115	24,0	480804	26,00

Características:

Sonda de acero inoxidable de 125 mm. \varnothing 3.5 mm.
Rango de - 50 a 200 °C / Resolución 0.1°

Characteristics:

Stainless steel 125 mm. \varnothing 3.5 mm probe.
Measurement from - 50 to 200 °C / Resolution 0.1°

Caractéristiques:

Sonde de 125 mm. \varnothing 3.5 mm. en acier inoxydable.
Mesurage de - 50 à 200 °C / Resolution 0.1°

Termómetro digital resistente al agua

Water-proof digital thermometer
Thermomètre digital résistant à l'eau

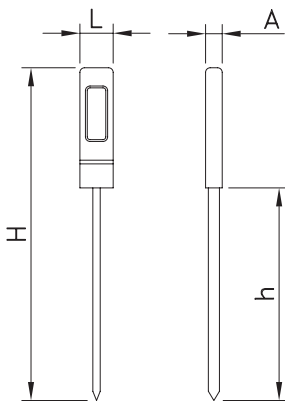

L	A	H	h	Gr	Barcode	€
20	20	195	110	36,0	480814	30,00

Características:

Sonda de acero inoxidable de 125 mm. \varnothing 3.5 mm.
Rango de - 50 a 200° C / Resolución 0.1°

Characteristics:

Stainless steel 125 mm. \varnothing 3.5 mm probe.
Measurement from - 50 to 200° C / Resolution 0.1°

Caractéristiques:

Sonde de 125 mm. \varnothing 3.5 mm. en acier inoxydable.
Mesurage de - 50 à 200° C / Resolution 0.1°

Termómetro con alarma resistente al agua

Water-proof digital thermometer alarm
Thermomètre digital avec alarme résistant à l'eau

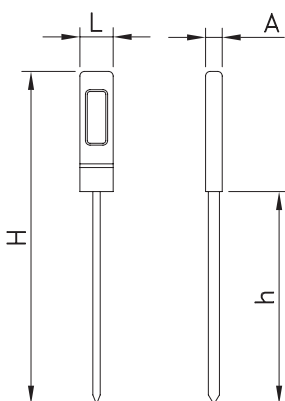
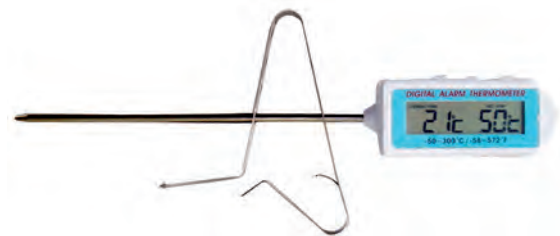

L	A	H	h	Gr	Barcode	€
70	10	195	125	97	480816	45,00

Características:

Sonda de acero inoxidable de 125 mm. \varnothing 3.5 mm.
Rango de -50 a 300° C / Resolución 1°
Con clip de fijación.

Characteristics:

Stainless steel 125 mm. \varnothing 3.5 mm probe.
Measurement from -50 to 300° C / Resolution 1°
With mounting clip.

Caractéristiques:

Sonde de 125 mm. \varnothing 3.5 mm. en acier inoxydable.
Mesurage de -50 à 300° C / Resolution 1°
Avec clip de fixation.

Termómetro digital con doble sonda para frigorífico-congelador

Digital thermometer for fridge and freezer with two probes

Thermomètre digital avec deux sondes pour réfrigérateur et congélateur



Characteristics:

Measurement from - 40 to 70 °C / Resolution 0.1°

Cable length: 1000 mm

Adjustable alarm.

With magnet.

Características:

Rango de - 40 a 70 °C / Resolución 0.1°

Cable 1000 mm.

Con alarma programable.

Con imán.

Caractéristiques:

Mesurage de - 40 à 70 °C / Résolution 0.1°

Longueur du câble: 1000 mm

Alarme réglable.

Avec aimant.

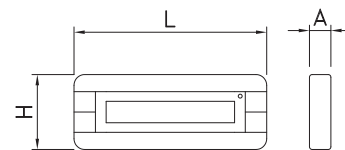

L	A	H	Gr	480822	€
135	15	45			40,00

Termómetro digital con sonda para frigorífico-congelador

Digital probe thermometer for fridge and freezer

Thermomètre digital à sonde pour réfrigérateur et congélateur



Características:

Rango de - 50 a 70 °C / Resolución 0.1°

Cable 1000 mm.

Con alarma programable.

Characteristics:

Measurement from - 50 to 70 °C / Resolution 0.1°

Cable length: 1000 mm

Adjustable alarm

Caractéristiques:

Mesurage de - 50 à 70 °C / Résolution 0.1°

Longueur du câble: 1000 mm

Alarme réglable

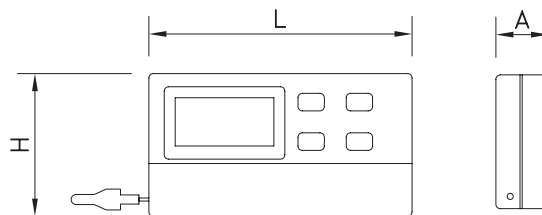

L	A	H	Gr	480806	€
60	35	430	80		29,00

Termómetro para barbacoa

Barbecue thermometer

Thermomètre pour barbaque



Características:
Resolución 0.1°

Characteristics:
Resolution 0.1°

Caractéristiques:
Résolution 0.1°

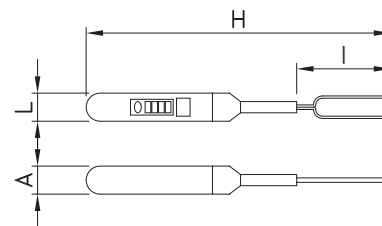

L	A	H	I	Gr	480818	€
40	35	430	150	216		46,00

Termómetro de bolsillo con sonda rotativa

Portable thermometer with rotating probe

Thermomètre portable avec sonde tournante



Características:

Rango de - 50 a 300 °C

Resolución 0.1°

Characteristics:

Measurement from - 50 to 300 °C

Resolution 0.1°

Caractéristiques:

Mesurage de - 50 à 300 °C

Resolution 0.1°

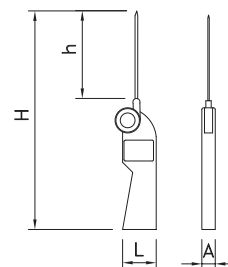

L	A	H	h	Gr	480820	€
50	15	290	117	112		44,00

Termómetro electrónico de sonda

Electronic probe thermometer
Thermomètre à sonde électronique

Proporciona en segundos la temperatura de los alimentos.

Provides in a few seconds the food temperature.

Il fournit en quelques secondes la température des aliments.

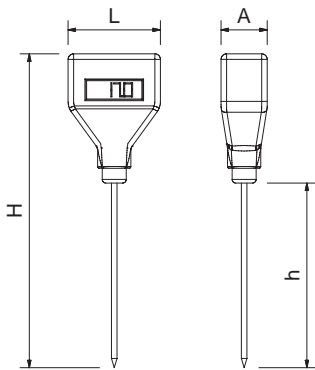

L	A	H	h	Gr	480802	€
50	25	180	105	50,0		78,00

Características:

Sonda de acero inoxidable de 150 mm.
Rango de -50 a 150° C
Precisión +- 1° C
1 Batería AA de 1.5

Characteristics:

Stainless steel 105 mm. probe.
Measurement from -50° C to 150° C
Deflection +- 1° C
1 battery AA 1.5

Caractéristiques:

Sonde de 105 mm. en acier inoxydable.
Mesurage de -50° C à 150° C
Déviation +- 1° C
1 pile AA 1.5



Termómetro digital pistola de infrarrojos

Digital infrared thermometer
Thermomètre digital à infrarouge

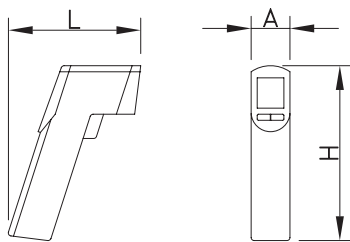

L	A	H	Gr	480812	€
75	30	160	220,0		90,00

Características:

Rango de -50 a 280 °C / Resolución 0.1°
Luz en pantalla.

Characteristics:

Range from -50 to 280 °C / Resolution 0.1°
Screen with backlight. Adjustable alarm

Caractéristiques:

Gamme de -50 à 280 °C / Résolution 0.1°
Écran avec rétro-éclairage.



Termómetro esfera con sonda para horno

Round thermometer with probe for oven
Thermomètre ronde avec sonde pour four

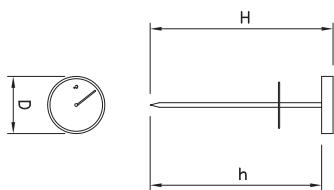

D	H	h	Gr	480824	€
52	160	145	180,0		27,00

Características:

Rango de 0 a 300 °C

Characteristics:

Range from 0 to 300 °C

Caractéristiques:

Gamme de 0 à 300 °C



Termómetro digital con sonda para horno

Digital oven thermometer with probe
Thermomètre digital à sonde pour four

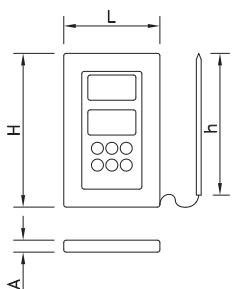

Características:

Sonda de acero inoxidable de 150 mm. ø 4 mm.
Rango de -50 + 300° C / Resolución 0.1°
Cable: 1000 mm.
Con alarma programable.
Reloj.

Characteristics:

Stainless steel 150 mm. ø 4 mm. probe.
Measurement from -50 to 300° C / Resolution 0.1°
Cable length: 1.000 mm.
Adjustable alarm.
Clock

Caractéristiques:

Sonde de 150 mm. ø 4 mm. en acier inoxydable.
Mesurage de -50 à 300° C / Résolution 0.1°
Longueur du câble: 1000 mm
Alarme réglable.
Montre.

L	A	H	h	Gr	480808	€
50	6	75	100	190,0		55,00



Termómetro digital de acero inoxidable

Stainless steel digital thermometer
Termomètre digital tout inox



Características:

Rango de -50°C a 300°C
Impermeable IP65
Temperatura Max/Min
Calibración automática
Retención de datos
Resolución 0,1° - Precisión +1°C / 2°F
Sonda de 125 mm ø 3,8 mm

Caractéristiques:

Mesurage de -50° C à 300 ° C
Étanche IP65
Tem. Maxi/Mini
Étalonnage automatique
Maintien des données
Résolution 0,1°C - Précision +1°C/2°F
Sonde 125 mm x ø 3,8 mm

Characteristics:

Measurement from -50° C to 300°C
Waterproof IP65
Max/Min temp.
Self calibration
Data Hold
Display 0,1° - Accuracy +1°C/2°F
Probe 125 mm ø 3,8 mm

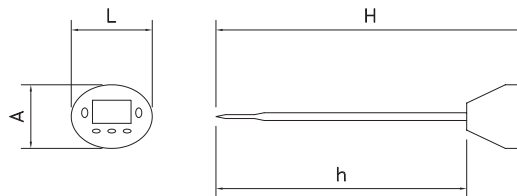

L	A	H	h	Gr	Barcode	€
42	33	160	125	60,0	480840	31,00

Termómetro digital para horno

Digital thermometer for oven
Thermomètre digital spécial four



Características:

Rango de -50°C a 300°C
Cronómetro 99' 59"
Sonda de acero inoxidable de 180, ø 4 mm
Cable de acero inoxidable 1 metro
Alarma
Imán

Caractéristiques:

Mesurage de -50° C à 300° C
Chronomètre 99' 59"
Sonde inox 180, ø 4 mm
Câble inox 1 mètre
Alarme
Dos aimanté

Characteristics:

Measurement from -50° C to 300°C
Stopwatch 99' 59"
Stainless steel probe 180, ø 4 mm
Stainless steel cable 1 meter
Alarm
With magnet

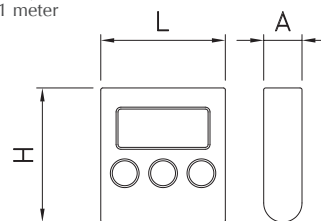

L	A	H	Gr	Barcode	€
65	70	70	80,0	480842	33,00

Termómetro para horno

Oven thermometer
Thermomètre pour four



Características:

Rango de -50°C a 300°C
Acero inoxidable
Colgante

Caractéristiques:

Mesurage de -50° C à 300 ° C
En inox
Avec crochet

Characteristics:

Measurement from -50° C to 300°C
Stainless steel
With hook

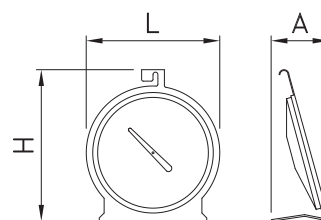

L	A	H	Gr	Barcode	€
83	35	95	100,0	480844	12,00

Termómetro compacto

Compact thermometer
Thermomètre compact



Características:

Sonda de acero inoxidable de 80 mm. ø 3,5 mm.
Rango de - 50 + 200° C / Resolución 0.1°

Characteristics:

Stainless steel 80 mm. ø 3,5 mm. probe.
Measurement from -50 to 200° C /
Resolution 0.1°

Caractéristiques:

Sonde de 80 mm. ø 3,5 mm. en acier
inoxydable.
Mesurage de -50 à 200° C / Resolution 0.1°

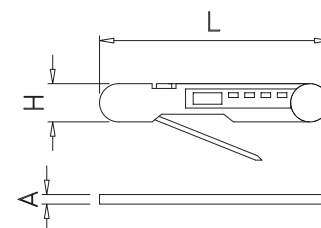

L	A	H	Gr	Barcode	€
140	10	28	80	480821	41,00

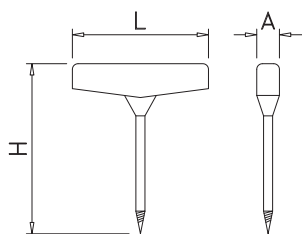

L	A	H	Gr	480830	€
120	20	150	145	480830	77,00

Termómetro con sonda para atornillar

Screw probe thermometer
Thermomètre avec sonde pour filetage

Características:

Sonda de acero inoxidable de 105 mm. ø 8 mm.
Rango de - 50 + 200° C / Resolución 0.1°

Characteristics:

Stainless steel 105 mm. ø 8 mm. probe.
Measurement from -50 to 200° C / Resolution 0.1°

Caractéristiques:

Sonde de 105 mm. ø 8 mm. en acier inoxydable.
Mesurage de -50 à 200° C / Resolution 0.1°

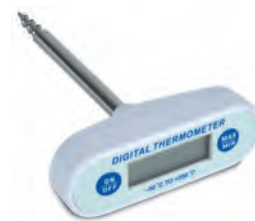

Termómetro pistola con sonda

Pistol thermometer with probe
Thermomètre en forme de pistolet avec sonde

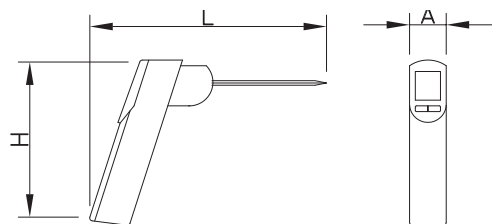

L	A	H	Gr	480832	€
75	30	160	250	480832	52,00

Características:

Sonda de acero inoxidable de 80 mm. ø 3,5 mm.
Rango de - 50 + 200° C / Resolución 0.1°

Characteristics:

Stainless steel 80 mm. ø 3,5 mm. probe.
Measurement from -50 to 200° C / Resolution 0.1°

Caractéristiques:

Sonde de 80 mm. ø 3,5 mm. en acier inoxydable.
Mesurage de -50 à 200° C / Resolution 0.1°



Termómetro con sonda larga

Long probe thermometer
Thermomètre sonde longue

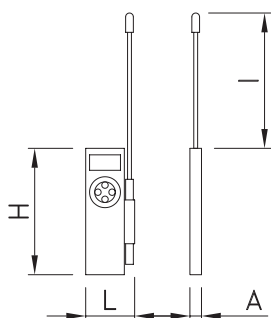

L	I	A	H	Gr	480834	€
60	200	18	180	120	480834	39,00

Características:

Sonda de acero inoxidable de 200 mm. ø 3,5 mm.
Rango de - 50 a 200 °C / Resolución 0.1°
Cable 1000 mm.

Characteristics:

Stainless steel 200 mm. ø 3,5 mm. probe.
Measurement from - 50 to 200 °C / Resolution 0.1°
Cable length: 1000 mm

Caractéristiques:

Sonde de 200 mm. ø 3,5 mm. en acier inoxydable.
Mesurage de - 50 à 200 °C / Resolution 0.1°
Longueur du câble: 1000 mm



Registrador de temperatura y humedad

Temperature and humidity recorder
Enregistreur de température et humidité

Características:

Resolución: 0,1°C.
Precisión: +-1°C.
Resolución humedad: De 1% en 1%.
Sensor interno + Sonda externa.
Sonda: 50 mm ø3mm.
Capacidad de grabación 8000 puntos.
Intervalo de grabación de 10 sg a 24 horas.
Cable 1 metro.

Impermeable IP65.

Conexión USB.

Alarma.

1 pila CR2450-3V.

De -40 a +85°C con la sonda.

De -30 a +60°C sin la sonda.

Registro de humedad de 0 - 99%.

USB connection.

Alarm.

1 battery CR2450-3V included.

Range: -30°C to 85°C with probe.

-30°C to 60°C without probe.

Humidity record: 0 - 99%.

Caractéristiques:

Résolution:0,1°C.

Précision: +-1°C.

Résolution humidité : de 1% en 1%

Capteur interne + la Sonde externe.

Sonde : 50 mms ø3mm.

Capacité d'enregistrement de 8000 points.

Intervalle d'enregistrement de 10 sg à 24 heures.

Câble de 1 mètre.

Imperméable IP65.

Connexion USB.

Alarme.

1 pile CR2450-3V.

De-40 à +85°C avec la sonde.

De-30 à +60°C sans la sonde.

Registre d'humidité de 0-99%

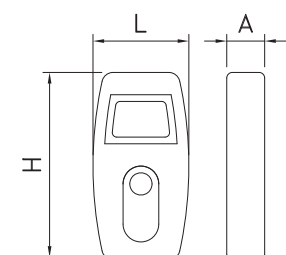

L	A	H	Gr	480852	€
43	17	84	102	480852	159,00

Cronómetro digital de cocina

Kitchen Digital timer
Minuterie de cuisine digital

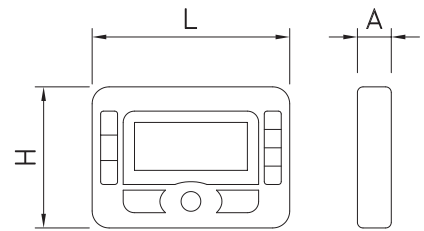

L	A	H	Gr	Barcode	€
70	12	50	120	480836	22,00

Cronómetro de cocina

Kitchen timer
Minuterie de cuisine

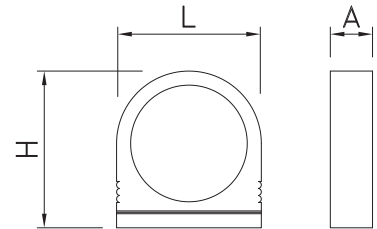

L	A	H	Gr	Barcode	€
60	20	70	120	480838	5,00

Check de cloro

Chlorine check
Check pour chlore



Novedad
ew
nouveaux



Reactivo líquido para
check cloro

Liquid reagents for
chlorine check
Réactifs liquides pour la
vérification du chlore



300 test 480827 **81,00**

Characteristics:

DPD standard method
Range: 0.00 to 2.50 ppm (mg/l)
Resolution: 0.01 ppm (mg/l)
Accuracy: +/-3% reading; +/- 0.03 ppm (mg/l) @ 25°C

Características:

Método estandarizado DPD
Rango: 0.00 a 2.50 ppm (mg/l)
Resolución: 0.01 ppm (mg/l)
Precisión: +/-3% lectura; +/- 0.03 ppm (mg/l) @ 25°C.

Caractéristiques:

DPD méthode standard
Gamme: 0.00 à 2.5 ppm (mg/l)
Résolution: 0.01 ppm (mg/l)
Précision: +/-3% lecture: +/- 0.03 ppm (mg/l) @ 25°C

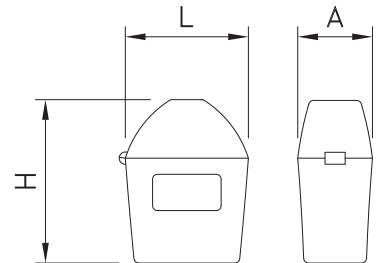

L	A	H	Gr	Barcode	€
61	37	81	64	480826	152,00

Medidor de PH

PH check
Check pour PH



Characteristics:

PH pocket meter
Waterproof with replaceable electrode
Resolution: 0.01 pH
Accuracy: +/- 0.1 pH / +/- 1 digit
Auto-calibration: pH 7.00

Características:

Medidor de PH de bolsillo
Impermeable con electrodo inter-
cambiable
Resolución: 0.01 pH
Precisión: +/-0.1 pH / +/- 1 digit
Auto-calibración: pH 7.00

Caractéristiques:

PH-mètre de poche
Étanche avec électrode remplaçable
Résolution: 0.01 pH
Précision: 0.1 pH +/- / +/- 1 chiffre
Auto-calibration: pH 7.00

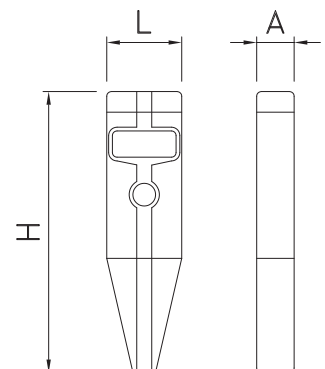

L	A	H	Gr	Barcode	€
40	20	150	350	480828	75,00

¿Qué es el Ozono?

El ozono (O₃) es uno de los componentes naturales del aire y su función es la de regular la temperatura y el grado de humedad del ambiente.

Los objetivos de la ozonización son cuatro:

Asepsia de los locales de manipulación, conservación y distribución de alimentos.

Disminución de pérdidas de peso de los alimentos durante su almacenaje.

Desodorización total de los locales y supresión de olores de unos alimentos a otros.

Posibilidad de aumentar el tiempo de almacenaje de los alimentos en un estado óptimo.

En lo que se refiere al primer objetivo, el ozono asegura la destrucción de los numerosos microorganismos que se encuentran en la superficie de los productos alimenticios al introducirlos en las cámaras frigoríficas. Manteniendo la cámara en las condiciones más asépticas posibles se dificulta el contagio de una pieza a otra.

Respecto a las mermas de peso, éstas se deben a las pérdidas de agua de los tejidos animales y vegetales. El ozono evitará en gran parte este proceso.

La desodorización se consigue gracias a la capacidad del ozono para oxidar la materia orgánica causante de los olores desagradables.

El último objetivo es fácilmente explicable por el amplio espectro antimicrobiano del ozono, capaz de destruir las bacterias, virus, hongos e incluso esporas.

Para más información ponemos a su disposición informes realizados en cámaras frigoríficas destinadas a la conservación de carnes, frutas y pescados.

Tipo de cámara Type of chamber Type de chambre	Coefficiente Coefficient Coefficient
Carnes Meat Viandes	1,5
Pescados Fish Poissons	1,7
Frutas y verduras Fruits & Vegetables Fruits el légumes	1,6
Mixtas Mixed Mixtes	1,5



What is Ozone?

Ozone (O₃) is one of the natural components of the air and its function is to regulate the temperature and the degree of humidity in the atmosphere.

Properties:

The use of ozone in cold-storage chambers is, at present, the only system of environmental decontamination that is radically and definitively effective.

It disinfects, absorbs odours and sterilizes.

It destroys fungi, bacteria and viruses - even the most resistant microbes - and thus losses are significantly reduced in the ozonized chambers. It also prevents the mixing of odours.

For further information, we can provide you with reports produced on refrigerated chambers used for the storage of meat, fruit and fish.

Qu'est-ce que l'ozone ?

L'ozone (O₃) est l'un des composants naturels de l'air et sa fonction consiste à régler la température et le degré d'humidité de l'atmosphère.

Propriétés:

L'apport d'ozone aux chambres frigorifiques est actuellement le seul système de décontamination environnementale qui agisse de façon radicale et définitive.

Il désinfecte, désodorise et stérilise.

Il détruit les champignons, les bactéries et même les microbes les plus résistants, aussi les pertes dans les chambres frigorifiques sont-elles considérablement réduites. Il évite le mélange d'odeurs.

Pour plus d'informations, nous mettons à votre disposition des rapports effectués dans des chambres frigorifiques destinées à la conservation de viandes, de fruits et de poissons.

¿Cómo elegir el equipo idóneo?

Multiplicar el volumen (en m³) de la cámara a ozonizar por el coeficiente correspondiente al tipo de cámara. Debemos escoger el equipo cuya producción de mg/h más se ajuste.

p. ej. En una cámara mixta de 4 x 3 x 3 m el cálculo sería el siguiente:

$$4 \times 3 \times 3 = 36 \text{ m}^3$$

$$36 \times 1,5 = 54$$

En este caso, el modelo necesario sería el H-20.

How to select the ideal equipment ?

Multiply the volume (in m³) of the chamber to be ozonized by the coefficient corresponding to the type in question. We must then choose the equipment whose production in mg/h most closely relates to that figure.

E.g. In a mixed chamber of 4 x 3 x 3 m, the calculation would be as follows:

$$4 \times 3 \times 3 = 36 \text{ m}^3$$

$$36 \times 1.5 = 54$$

In this case, the required model would be the H-20.

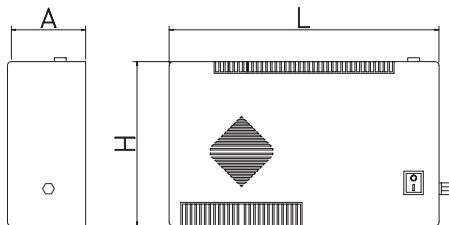

Usos Wearing Usage	Coefficiente Coefficient Coefficient
Olor penetrante Penetrating smell Odeur pénétrant	0,8
Olor intenso Intense smell Odeur intense	0,7
Olor moderado Moderated smell Odeur modéré	0,6

Comment choisir l'équipement idéal ?

Multiplier le volume (en m³) de la chambre à ozoniser par le coefficient correspondant au type de chambre. L'on doit choisir l'équipement dont la production de mg/h s'adapte le mieux. Par ex., dans une chambre mixte de 4 x 3 x 3 m, le calcul sera le suivant:

$$4 \times 3 \times 3 = 36 \text{ m}^3$$

$$36 \times 1.5 = 54$$

Dans ce cas, le modèle nécessaire serait le H-20.

Modelo Type Modèle	L	A	H	Producción Production Production mg/h	Tensión Voltage Tension	Frecuencia Frequency Fréquence	Potencia Power Puissance	Barcode	€
H-10	355	110	220	30	220 V	50 Hz	15 W	485202	528,00
H-20	355	110	220	60	220 V	50 Hz	18 W	485204	555,00
H-30	355	110	220	90	220 V	50 Hz	19 W	485206	581,00
H-50	400	170	450	500	220 V	50 Hz	55 W	485208	2.620,00
H-100	400	170	450	1.000	220 V	50 Hz	70 W	485212	3.200,00

Cañón de ozono portátil

Portable ozone generator
Générateur d'ozone portable



Características:

Diseñado para desinfectar y desodorizar habitaciones de hoteles en pocos minutos.
Rápido y eficiente.
Manejable y fácil de usar.

Characteristics:

Specially designed for disinfection and deodorizing hotel rooms in a few minutes.
Quick and effective.
Handy and easy to use.

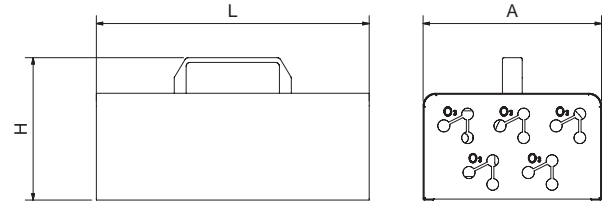

Caractéristiques:

Spécialement conçu pour la désinfection et la désodorisation de chambres d'hôtel en quelques minutes.
Rapide et efficace.
Maniable et facile à utiliser.

L	A	H	Producción Production Production mg/h	Tensión Voltage Tension	Frecuencia Frequency Fréquence	Potencia Power Puissance	Kg	448420	€
345	225	135	7.000	220 V	50 Hz	62 W	3,50		1.058,00

Cortina de ozono especial pescaderías

Ozone curtain, especially for fishmongers
Rideau d'ozone spécial pour poissonneries

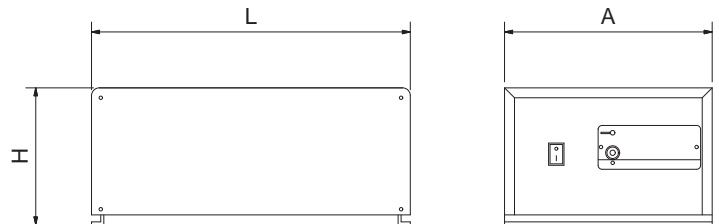

Características:

Reducción máxima del fuerte olor que desprende la sección de pescadería.
Mantiene durante más tiempo el aspecto de los pescados expuestos sobre el mostrador.
Reduce la carga microbiana presente en el pescado.
Fácil instalación.

Characteristics:

Maximum reduction of odors that are generated in fishmongers.
It keeps the good appearance of fishes exhibited in displays.
It eliminates the microbes present in fishes.
Easy to install.

Caractéristiques:

Réduction maximale des odeurs qui sont générés dans les poissonneries.
Il maintient la bonne apparence des poissons exposés dans les écrans.
Il élimine les microbes présents dans les poissons.
Facile à installer.



L	A	H	↔	Tensión Voltage Tension	Frecuencia Frequency Fréquence	Potencia Power Puissance	Kg	448430	€
380	200	160	0-10 mts.	220 V	50 Hz	80 W	5,00		2.443,00

Esterilizador de cuchillos mediante agua caliente para adosar

Hot water knifeholder disinfectant for mounting
Porte-couteaux désinfecteur à l'eau chaude pour adosser

Características:

Entrada de agua y desagüe con llave de corte, rebosadero, resistencia eléctrica protegida con termostato. Capacidad: 24 cuchillos.

Characteristics:

Water inlet and drain with stopcock, overflow, electrical resistance protected with thermostat. Capacity: 24 knives.

Caractéristiques:

Entrée d'eau et robinet d'écoulement, déversoir, résistance électrique avec thermostat. Capacité: 24 couteaux.

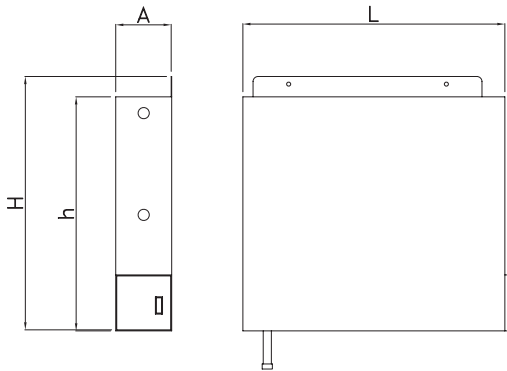

L	A	H	h	Tensión Voltage Tension	Frecuencia Frequency Fréquence	Potencia Power Puissance	Kg	Barcode	€
515	105	490	460	220 V	50 Hz	1.000 W	10,65	040402	680,00



Cuchillero con alojamiento especial para tijeras y chairas.
Knife-holder with special lodging for scissors and sharpeners.
Porte-couteaux avec logement spécial pour ciseaux et fusils à affûter.



Repuestos.
Spare parts.
Pièces de rechange.

360

Esterilizador de cuchillos mediante ozono para adosar

Ozone knifeholder disinfectant for mounting
Porte-couteaux désinfecteur à l'ozone pour adosser

Características:

Interruptor luminoso On/Off. Toma de tierra.

Characteristics:

On/Off lighting switch. Ground.

Caractéristiques:

Interrupteur lumineux On/Off. Prise de terre.

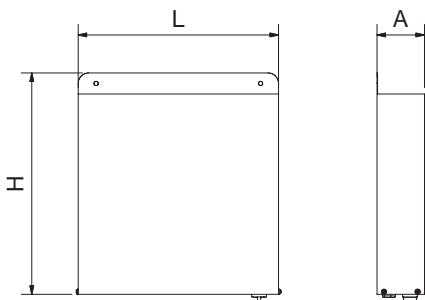

L	A	H	Tensión Voltage Tension	Frecuencia Frequency Fréquence	Potencia Power Puissance	Kg	Barcode	€
380	90	420	220 V	50 Hz	10 W	5	040472	215,00



Capacidad: 20 cuchillos
Capacity: 20 Knives
Capacité: 20 couteaux



Repuestos.
Spare parts.
Pièces de rechange.

360

Armarios esterilizadores de cuchillos rayos U.V.

U.V. knives disinfectant cabinets
Armoires désinfectants de couteaux U.V.



Principios de funcionamiento:

La lámpara emite rayos ultravioleta germicidas que transforman el oxígeno en ozono, destruyendo así las bacterias mediante la hiper-oxidación.

No es preciso demostrar ya el efecto de la radiación U.V.C. Es totalmente bactericida, antiviral, germicida, etc.

Los armarios generadores de U.V.C. aseguran así una excelente descontaminación de los utensilios situados en los cuchilleros.

Estos armarios, en conformidad con las normas de higiene, encuentran su aplicación en todos los sectores de la industria y de los comercios de la alimentación.

Construidos en acero inoxidable, están concebidos para durar y para ser instalados incluso en ambientes húmedos.

Working:

The lamp emits ultraviolet germinated rays, that made oxygen become ozone, destroying the germs by the hiper-rusting. It is not necessary demonstrate the effect of the radiation U.V.C. It is totally bacterized, anti-virus, germicized, etc.

The U.V. generator cabinet assure the excellent descontamination of the tools. These cabinets, obeing the hygienic norms, find application in all the industry sectors and alimentary comeres.

They are made of stainless steel, and are made to last and be installed even in humid places.



Barra para colgar accesorios.

Utensil rack.
Barre pour accrocher des accessoires.

360

Fonctionnement:

La lampe emit des rayons ultraviolets germicides, qui transforment l'oxigen en ozone, en détruiant les bactéries par l'hiper-oxidation. Il n'est pas precis démontrer l'effect de la radiation U.V.C. C'est totalement bactericide, antiviral, germicide, etc.

Les armoires generateur U.V. assurent comme ça une excelente décontamination des outils. Cettes armoires, en obeiant avec le normes d'hygiene, trouvent application dans tout les secteurs de l'industrie et des comeres d'alimentation.

Construit en acier inoxydable, il sont conçus pour une longue durée et pour son installation même sous atmosphères humides.

Características:

Construido en chapa de acero inoxidable acabado esmerilado.

Lámpara U.V.C.

Characteristics:

Made in stainless steel polish finished.
Lamp U.V.C.

Caractéristiques:

Construit en acier inoxydable.
Lamp U.V.C.



Enchufe con mando a distancia.

Remote controlled RF socket.
Connectez avec télécommande.

359

Includo / Included / Inclus Opcional / Optional / Optionnel



Capacidad 20 y 40 cuchillos respectivamente

Capacity 20 and 40 knives respectively
Capacité 20 et 40 couteaux respectivement



Repuestos.

Spare parts.
Pièces de rechange.

360

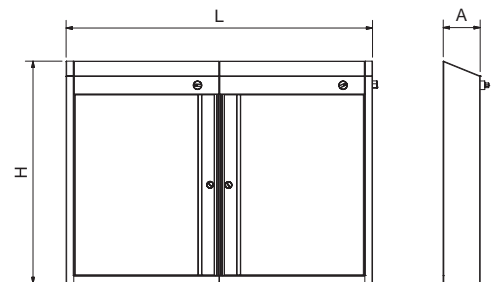

L	A	H	Tensión Voltage Tension	Frecuencia Frequency Fréquence	Potencia Power Puissance	Kg	Barcode	€
523	120	723	220 V	50 Hz	15 W	9,00	040450	475,00
996	120	723	220 V	50 Hz	30 W	17,00	040452	850,00

Armario esterilizador de cuchillos mediante Ozono

Ozone sterilizing cabinet for knives
Armoire stérilisateur de couteaux à l'ozone

Características:

Armario construido en acero inoxidable de gran espesor.
Interruptor luminoso On/Off.
Toma de tierra.

Characteristics:

Cabinet made of stainless steel.
On/Off lighting switch.
Ground.

Caractéristiques:

Construit en acier inoxydable.
Interrupteur lumineux On/Off.
Prise de terre.

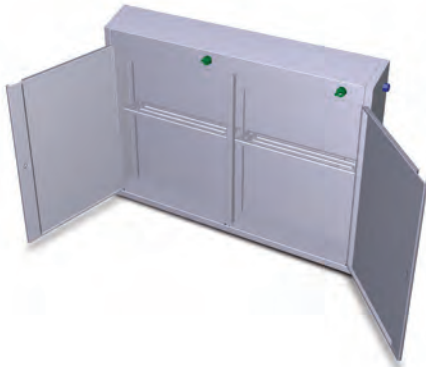

Barra para colgar accesorios.
Utensil rack.
Barre pour accrocher des accessoires.

 360



Enchufe con mando a distancia.
Remote controlled RF socket.
Connectez avec télécommande.

 359

 **Incluido** / Included / Inclus  **Opcional** / Optional / Optionnel

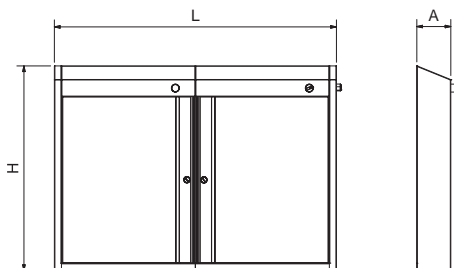

Capacidad 20 y 40 cuchillos
respectivamente
Capacity 20 and 40 knives respectively
Capacité 20 et 40 couteaux respectivement

L	A	H	Tensión Voltage Tension	Frecuencia Frequency Fréquence	Potencia Power Puissance	Kg		€
523	120	723	220 V	50 Hz	10 W	9	040460	460,00
996	120	723	220 V	50 Hz	20 W	17	040462	750,00



360

Repuestos.
Spare parts.
Pièces de rechange.

Armario inox esterilizador de utillaje y calzado

Stainless steel sterilisers wardrobe for tools and shoes

Armoire inoxydable pour la stérilisation des outils et des chaussures



Características:

3 niveles para colgar botas y zapatos
Sistema de desinfección por ozono.

Characteristics:

3 racks for hanging boots and shoes
Disinfection system: Ozone

Caractéristiques:

3 niveaux pour ranger bottes et chaussures
Système de désinfection: Ozone



El pomo admite la colocación de candado.
Handle-holder kit.
Kit porte-manches.



336





Opcional / Optional / Optionnel

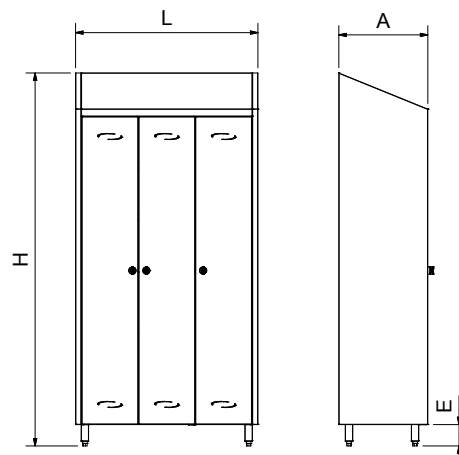

Posibilidad de acoplar ruedas ver pág 466
Possibility of assembly wheels, see page 466
Possibilité d'accoupler rouelles, voir page 466



L	A	H	E		Tensión Voltage Tension	Frecuencia Frequency Fréquence	Potencia Power Puissance			€
985	480	2010	115	3	220 V	50 Hz	10 W	57,50	081610	1.650,00



Portacuchillos inox portátil

Portable stainless steel knife holder
Porte couteaux inoxydable transportable



Válido para acoplar a los siguientes modelos de esterilizadores de cuchillos:
Valid for being adapted to the following models knife sterilisers:
Valable pour être adaptés aux modèles suivants de stérilisateur à couteaux:



040472

040450
040460

040452
040462

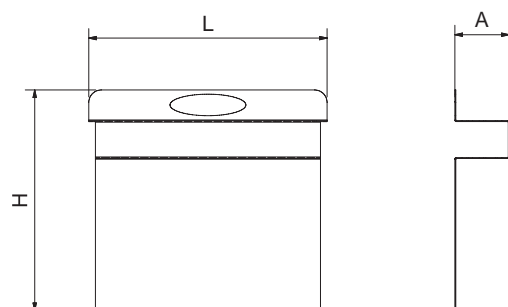

Capacidad: 20 cuchillos
Capacity: 20 Knives
Capacité: 20 couteaux

L	H	A	Kg	Barcode	€
377	349	86	2,40	041050	51,00

Accesorios

Accessories
Accessoires



Enchufe con mando a distancia Remote controlled RF socket Connectez avec télécommande	Tensión Voltage Tension	Frecuencia Frequency Fréquence	Range	Battery	Gr	Barcode	€
	240V	50 Hz	30 mts.	A23-12v	215	485892	25,00







Consumo máximo admisible 3.600 W.
3.600 W Maximum admissible consumption.
Consommation maximale autorisée 3.600 W.

Repuestos para esterilizadores

Spare parts for sterilizing cabinets

Pièces de rechange pour stériliseurs

		Gr	Barcode	€
		Resistencia Résistance Resistance	900 449040	193,00
		Transformador Transformer Transformateur	1.150 448458	109,00
		Válvula con malla de 170 mm 170 mm wire netting lamp Lampe à grille de 170 mm	50 448454	44,00
		Válvula con malla de 350 mm 350 mm wire netting lamp Lampe à grille de 350 mm	65 448456	66,00
		Interruptor luminoso On/Off On/Off lighting switch Interrupteur lumineux On/Off	10 448480	47,00
		Adhesivo ventana Sticker for door screen Autocollant pour fenêtre à porte	10 480222	8,00
		Cerradura Lock Serrure	41 481404	7,00
		Lámpara de 15 W 15 W lamp Lampe de 15 W	80 448508	63,00
Lámpara de 30 W 30 W lamp Lampe de 30 W		150 448510	79,00	
		Estárter para 15 W Starter for 15 W Starter pour 15 W	7 448516	4,00
	Estárter para 30 W Starter for 30 W Starter pour 30 W	7 448518	5,00	
	Barra para colgar accesorios Utensil rack Barre pour accrocher des accessoires	9 240438	3,00	

Exterminador de insectos mediante parrilla eléctrica serie UK-INOX

UK-INOX model insect exterminator by electric grill
Exterminateur d'insectes à grill électrique modèle UK-INOX

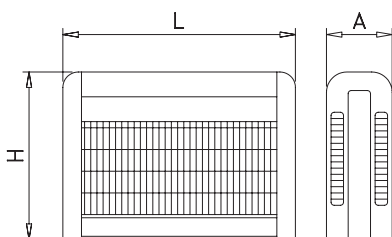

L	A	H	Modelo Model Modèle	Potencia Power Puissance	Frecuencia Frequency Fréquence	Tubo Tube Tube	Cobertura Coverage Couverture	Consumo Consumption Consommation	Kg	Barcode	€
380	105	260	UK-40 INOX	16 w	50 Hz	2x8 W	40 m ²	23 W	2,7	485844	79,00
530	105	260	UK-80 INOX	30 w	50 Hz	2x15 W	80 m ²	38 W	3,9	485846	99,00
695	105	285	UK-240 INOX	80 w	50 Hz	2x40 W	240 m ²	89 W	5,7	485848	135,00

Exterminador de insectos mediante trampa adhesiva serie UL

UL model insect exterminator by adhesive trap
Exterminateur d'insectes à trappe adhésif modèle UL



Características:

Silencioso y discreto. Diseño moderno y compacto. Placa adhesiva de fácil sustitución, con mayor área de captación. El aparato no sólo atrae más insectos que los aparatos convencionales, sino que además lo hace de forma más higiénica. Material de alta calidad, fácil mantenimiento. 2 años de garantía.

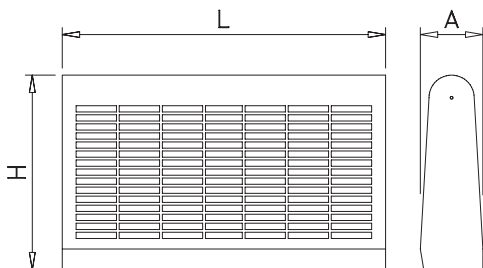

Characteristics:

Silent and sober. Modern and compact design. Easy to replace adhesive trap, with higher coverage area. This device not only appeals more insects than the conventional ones, but it also does it in a more hygienic way. High quality material and easy maintenance. 2 years of guarantee.

Caractéristiques:

Silencieux et sobre. Design d'avant garde et compact. Trappe adhésif facile à substituer, avec plus grande zone de couverture. L'appareil non seulement attire plus d'insectes mais encore il les attire d'une forme plus hygiénique. Matériel d'haute qualité et facile maintien. Garantie de 2 années.

L	A	H	Modelo Model Modèle	Potencia Power Puissance	Frecuencia Frequency Fréquence	Tubo Tube Tube	Cobertura Coverage Couverture	Consumo Consumption Consommation	Kg	Barcode	€
470	95	290	UL-80	30 W	50 Hz	2x15 W	80 m ²	45 W	3,85	485838	150,00

Exterminador de insectos mediante trampa adhesiva serie MR

MR model insect exterminator by adhesive trap
Exterminateur d'insectes à trappe adhésif modèle MR



Características:

Silencioso y discreto. Diseño moderno y compacto. Placa adhesiva de fácil sustitución, con mayor área de captación. El aparato no sólo atrae más insectos que los aparatos convencionales, sino que además lo hace de forma más higiénica. Material de alta calidad, fácil mantenimiento. 2 años de garantía.

Characteristics:

Silent and sober. Modern and compact design. Easy to replace adhesive trap, with higher coverage area. This device not only appeals more insects than the conventional ones, but it also does it in a more hygienic way. High quality material and easy maintenance. 2 years of guarantee.

Caractéristiques:

Silencieux et sobre. Design d'avant garde et compact. Trappe adhésif facile à substituer, avec plus grande zone de couverture. L'appareil non seulement attire plus d'insectes mais encore il les attire d'une forme plus hygiénique. Matériel d'haute qualité et facile maintien. Garantie de 2 années.

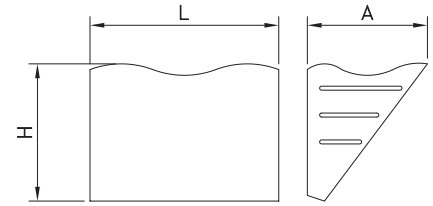

L	A	H	Modelo Model Modèle	Potencia Power Puissance	Frecuencia Frequency Fréquence	Tubo Tube Tube	Cobertura Coverage Couverture	Consumo Consumption Consommation	Kg	Barcode	€
330	210	240	MR-40	18 W	50 Hz	1x18 W	40 m ²	25 W	2,4	485894	70,00

Exterminador de insectos serie SP-80

SP model insect exterminator by adhesive trap
Exterminateur d'insectes à trappe adhésif modèle SP

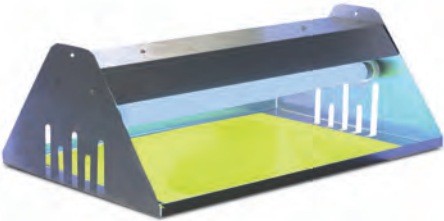

Características:

Silencioso, discreto, sin explosión de insectos y sin olores. El aparato no sólo atrae más insectos que los aparatos convencionales, sino que además lo hace de una manera más higiénica al quedar el insecto atrapado en su trampa de film adhesivo. Resistente a la humedad y rayos UV. Permite una instalación colgante o mural, incluye kit necesario de cadena y soportes.

Characteristics:

Silent, discreet and odor free. No insect explosion. This device not only attracts more insects than the conventional ones, but also does it in a more hygienic way since the insects are trapped on its glue trap, resistant to moisture and UV rays. For hanged or wall installation, chain and supports included.

Caractéristiques:

Silencieux, discret, sans explosion d'insectes et sans odeurs. Le dispositif non seulement attire plus d'insectes que les dispositifs classiques, mais aussi le fait de forme plus hygiénique car l'insecte reste attrapé dans son piège de film adhésif, résistant à l'humidité et aux rayons UV. Il permet une installation en suspension ou murale, le kit comprend la chaîne et les supports.

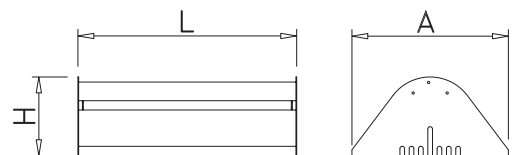

L	A	H	Modelo Model Modèle	Potencia Power Puissance	Frecuencia Frequency Fréquence	Tubo Tube Tube	Cobertura Coverage Couverture	Consumo Consumption Consommation	Kg	Barcode	€
485	350	160	SP-80	30 W	50 Hz	2x15 W	80 m ²	30 W	3,6	485832	176,00

Atrapador de insectos Tephri Trap

Tephri Trap insect trap
Piège à insectes Tephri Trap



Características:

Atrapador de insectos con cuatro agujeros para aumentar el flujo de los atrayentes

Versátil, puesto que puede trabajar en seco mediante parches atrayentes y en húmedo mediante proteínas hidrolizadas (Nulure, Buminal, etc). Capacidad 400 cc.

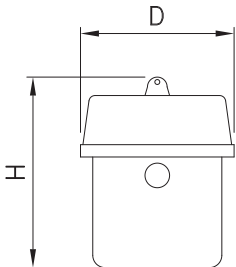

D	H	Gr	485802	€
125	155	136	485802	7,00

Characteristics:

Insect trap provided with four holes to increase the flow of the attractant lure

Versatile since it can operate in dry mode by means of attractant patches or in wet mode by means of hydrolyzed proteins (Nulure, Buminal, etc.) Capacity: 400 cc.

Caractéristiques:

Piège à insectes avec 4 trous pour augmenter le flux des insectes attirés

Versatile puisqu'on peut l'utiliser en sec avec des patches et en humide avec des protéines hydrolysées -Capacité 400 cc.

Atrapador de insectos Easy Trap

Easy Trap insect trap
Piège à insectes Easy Trap



Características:

Fácil manejo, posibilidad de trabajar en seco y en húmedo. Gran eficacia.

Diseñado especialmente para atrapar todas las moscas de las frutas (Ceratitis, Bactrocera, Ragholetis, Anastrepha, etc.), pero puede atrapar otros muchos insectos si se usa con los atrayentes adecuados (por ej. Drosophilas, moscardas y avispas).

Revolucionario diseño que permite una óptima dispersión de los atrayentes de su interior y un dispositivo seguro de retención de los insectos.

Facilidad para ser colgado por su percha adaptable.

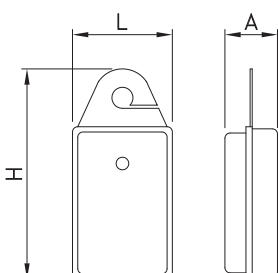

Characteristics:

Easy to use. Two operating modes: dry and wet. High efficiency.

Designed to catch fruit flies (Ceratitis, Bactrocera, Ragholetis, Anastrepha, etc.) In addition, if the adequate attractant lures are used, it can also trap many other insects such as drosophilas, blow flies and wasps.

State of the art design for an optimal spreading of the attractant lures outwards with an insect retention security device

Its adaptable sling bar makes it easy to hang.

Caractéristiques:

Facile usage, possibilité d'utiliser en sec ou en humide, Grande efficacité

Conçu pour attraper spécialement toutes les mouches (Cératit, Bactrocera, Ragholetis, Anastrepha, etc) mais peut également attraper d'autres insectes si on l'utilise avec les appâts appropriés (par ex. Drosophilas, moscardas et guêpes)

Révolutionnaire design qui permet une dispersion optimum des appâts en son intérieur et un dispositif sûr de retenue des insectes

S'accroche facilement grâce à son crochet adaptable

L	A	H	Gr	485804	€
95	50	200	56	485804	6,00

Exterminador de insectos mediante trampa adhesiva serie BC

BC series insect exterminators by adhesive trap
Exterminateurs d'insectes à trappe adhésif serie BC

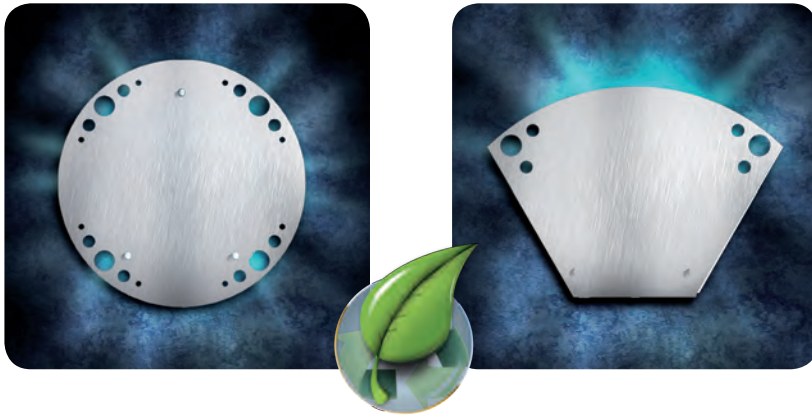

Características:

El diseño innovador de la serie BC agrupa la eficiencia del control de insectos voladores y la estética contemporánea y moderna de un aplique de luz. Sus diferentes diseños permiten escoger el modelo que mejor se integre con el lugar de utilización.

Sus ventajas con respecto a otros aparatos son:

Construidos en acero inoxidable.

Diseño exclusivo. Carátulas intercambiables.

Silenciosos.

Ahorro energético: Lámpara de bajo consumo. Sin transformadores, cebadores, etc. garantizando fiabilidad y poco mantenimiento.

Posibilidad de lavarlos o esterilizarlos al poderse introducir en máquinas de lavado, lavavajillas o directamente bajo el agua, desmontando fácilmente y sin herramientas la parte eléctrica.

Ideal para cualquier lugar donde el control de los insectos deba ser discreto y el uso de un exterminador convencional resultaría inapropiado. Recomendado para restaurantes, cafeterías, bares, hoteles, oficinas, tiendas de alimentación, zonas de manipulación de alimentos etc.

Characteristics:

The innovative design the BC series joins the efficiency in flying insect control and the contemporary and modern aesthetic of a wall lamp. Its different designs allow you to choose the most suitable model for the place of usage.

Its advantages in relation to other devices are:

Made of stainless steel.

Exclusive design with exchangeable covers.

Silent.

Power saving with low consumption lamps. Without transformers, chokes, etc. It guarantees liability and low maintenance.

Possibility of washing or sterilizing in washing machines, dishwashers or directly under water, just dismantling the electrical components easily, without any tool.

Perfect for any place where the insect control must be discrete and the usage of a conventional insect killer would be improper. It is recommended for restaurants, cafes, bars, hotels, offices, food shops, food handling zones, etc.

Caractéristiques:

Le design innovateur du modèle BC attache l'efficacité du control des insectes volants et l'esthétique contemporaine et moderne d'un applique. Son designs différents permettent choisir le modèle que plus s'intègre avec l'endroit d'utilisation.

Les avantages par rapport autres modèles sont :

Construit en acier inoxydable.

Design exclusif avec façades interchangeables.

Silencieuses.







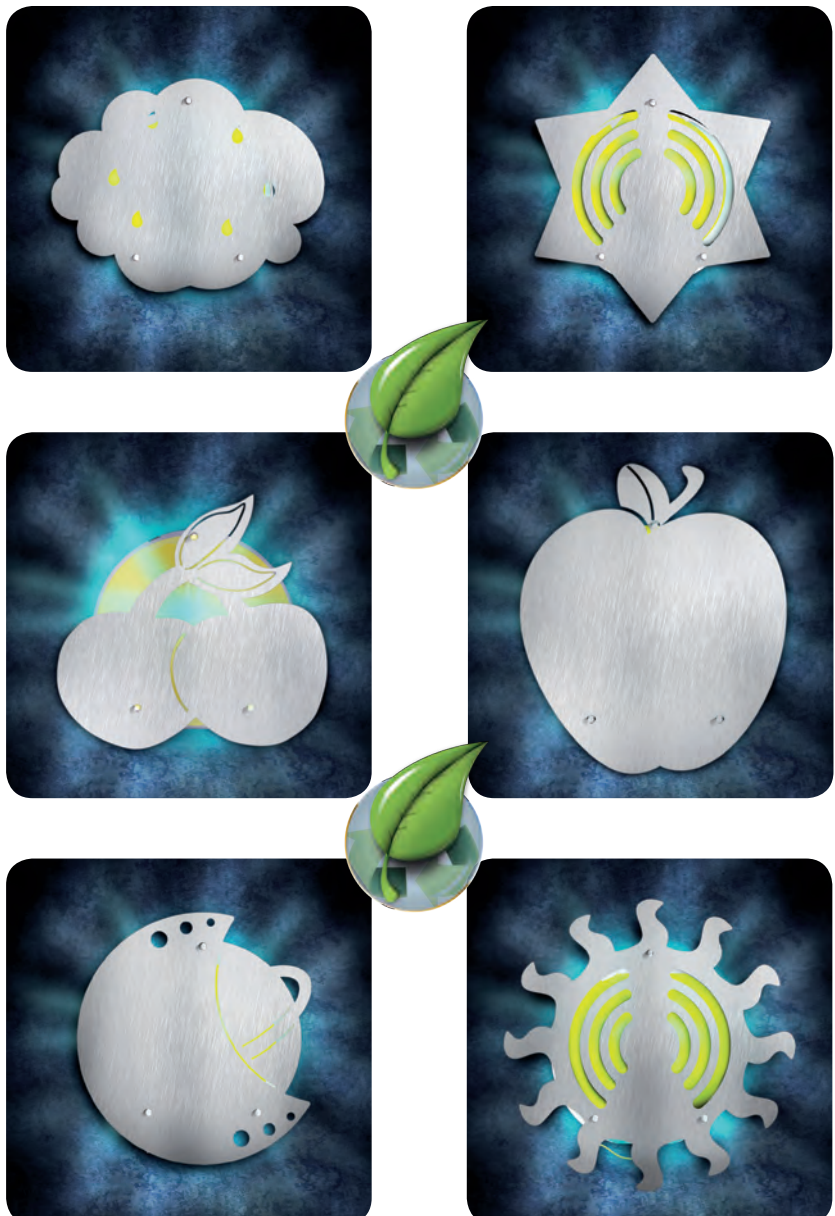

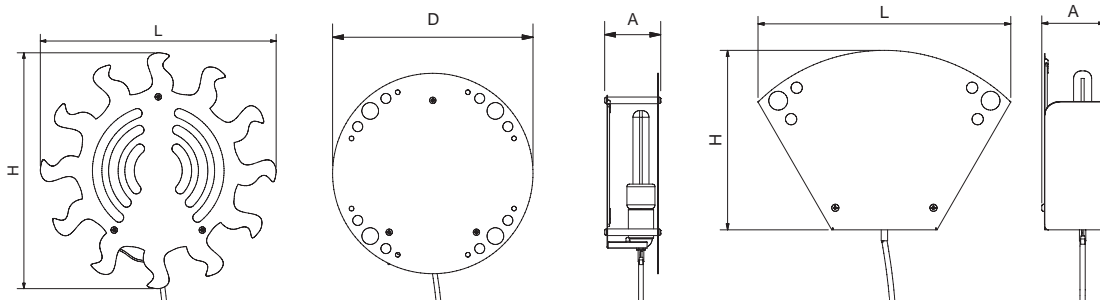























Économie énergétique. Lampe de consommation bas sans transformateur ou poire qui garantie fiabilité et maintenance

Possibilité de le laver ou le stériliser puisque il peut se mettre dans machines à laver, lave-vaisselles ou directement sous l'eau. Facile à démonter sans outils.

Parfait pour quelque endroit ou le control des insectes doit être discret et l'usage d'un exterminateur conventionnel serait inadéquat. Racommandé pour restaurants, cafés, bars, hôtels, bureaux, magasins d'alimentation, zones de manipulation d'aliments, etc.

















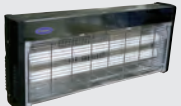





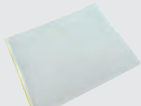

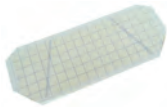
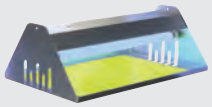
	L	D	A	H	Modelo Model Modèle	Potencia Power Puissance	Cobertura Coverage Couverture	W	Tensión Voltage Tension	Frecuencia Frequency Fréquence	Kg	Barcode	€
		300	84		Industrial	 20 W	50 m ²	20 W	220/240 V	50/60 Hz	1,1	085810	110,00
						 20 W						086010	129,00
	336		84	240	AP-INOX	 20 W	50 m ²	20 W	220/240 V	50/60 Hz	1,7	085812	120,00
						 20 W						086012	139,00
	350		84	350	Sol	 20 W	50 m ²	20 W	220/240 V	50/60 Hz	0,96	085802	135,00
						 20 W						086002	154,00
	280		84	300	Luna	 20 W	50 m ²	20 W	220/240 V	50/60 Hz	1,13	085804	135,00
	300		84	345	Estrella	 20 W	50 m ²	20 W	220/240 V	50/60 Hz	0,94	085806	135,00
	343		84	269	Nube	 20 W	50 m ²	20 W	220/240 V	50/60 Hz	1,10	085808	135,00
	271		84	315	Manzana	 20 W	50 m ²	20 W	220/240 V	50/60 Hz	1,04	085814	135,00
	310		84	293	Cerezas	 20 W	50 m ²	20 W	220/240 V	50/60 Hz	0,96	085816	135,00
	300		84	300	Pollería	 20 W	50 m ²	20 W	220/240 V	50/60 Hz		085818	135,00
	300		84	300	Queso	 20 W	50 m ²	20 W	220/240 V	50/60 Hz		085821	135,00
	300		84	300	Carnicería	 20 W	50 m ²	20 W	220/240 V	50/60 Hz		085822	135,00
	300		84	300	Charcutería	 20 W	50 m ²	20 W	220/240 V	50/60 Hz		085824	135,00
	300		84	300	Variantes	 20 W	50 m ²	20 W	220/240 V	50/60 Hz		085826	135,00
	300		84	300	Panadería	 20 W	50 m ²	20 W	220/240 V	50/60 Hz		085828	135,00
	300		84	300	Pescadería	 20 W	50 m ²	20 W	220/240 V	50/60 Hz	1,09	085829	135,00

Repuestos para exterminadores de insectos







Spares for insect exterminators
Recharges pour exterminateurs d'insectes

Modelo Model Modèle	Bombilla Light bulb Ampoule	Trampas adhesivas Adhesive traps Trappes adhésives
 485844	 485856	<input type="checkbox"/>
 485844	 485857	<input type="checkbox"/>
 485846	 485860	<input type="checkbox"/>
 485848	 485866	<input type="checkbox"/>
 485838	 485860	<input type="checkbox"/>
 485894	 485862	 485897
 485894	 485862	 485898
 485832	 485860	 485852
 0858xx	 485886	 485880
	 485887	

Repuestos para exterminadores de insectos serie BC

BC series spares for insect exterminators
Recharges pour exterminateurs d'insectes serie BC

		Unidades por caja Box units Unités par boîte				
						
	Trampas adhesivas Adhesive traps Trappes adhésives	6	250	485880	18,00	* Luz negra: especial para atraer a los insectos tanto durante el día como durante la noche. Black light special to attract insects during the day and at night. La lumière noire spéciale pour attirer les insectes pendant le jour et la nuit.
	20 W - Luz negra * 20 W - Black light 20 W - Lumière noire	1	110	485886	18,00	** Luz blanca: especial para atraer a los insectos durante la noche o simplemente para su uso como luminaria. White light special to attract insects at night or simply for use as a luminaire. La lumière blanche spéciale pour attirer les insectes de nuit ou tout simplement pour une utilisation comme luminaire.
	20 W - Luz blanca ** 20 W - White light 20 W - Lumière blanche	1	120	485887	16,00	
	9 W - Bombilla LED RGB E27 con mando a distancia RGB LED bulb E27 9W with remote control Ampoule LED RGB E27 9 W avec télécommande	1	200	485891	36,00	

		Tensión Voltage Tension	Frecuencia Frequency Fréquence					
	Enchufe con mando a distancia Remote controlled RF socket Connectez avec télécommande	240V	50 Hz	30 mts.	A23-12v	215	485892	25,00

Adaptador enchufe tipo H

Type H plug adapter
Adaptateur pour prise électrique type H







Novedad
ew
ouveau

Tensión Voltage Tension	Frecuencia Frequency Fréquence			
220 V	50 Hz	56	485878	6,00

Repuestos para exterminadores de insectos

Spares for insect exterminators

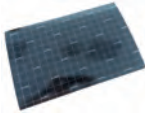
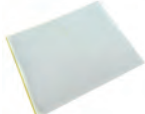
Rechanges pour exterminateurs d'insectes

	Modelo Modèle Model	Unidades por caja Box units Unités par boîte				
	SP-80	6	530	485852		  €
	UL	6	110	485872		
Trampas adhesivas Adhesive traps Trappes adhésives		MR-40	5	485897		15,00
		MR-40 BIS	6	250	485898	18,00
		MR-70	6	290	485899	23,00
	Tubo 8 W	UK-40 INOX	1	25	485856	7,00
	Tubo 11 W	UK-40 INOX (Bis)	1	25	485857	7,00
	Tubo 15 W	MR-70	1	25	485858	12,00
	Tubo 15 W	UL-80 / UK-80 INOX / SP-80	1	70	485860	8,00
	Tubo 18 W	MR-40	1	75	485862	18,00
	Tubo 40 W	UK-240 INOX	1	155	485866	11,00

Contenedor de desperdicios

Waste bin

Conteneur à ordures

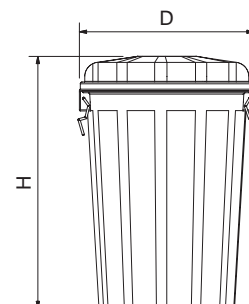

H	D	lit	Kg		€
600	455	70 lts	5	486023	26,00
730	495	95 lts	6	486022	27,00

Contenedor de desperdicios con tapa y ruedas

Waste bin with lid and wheels
Conteneur à ordures avec couvercle et roulettes

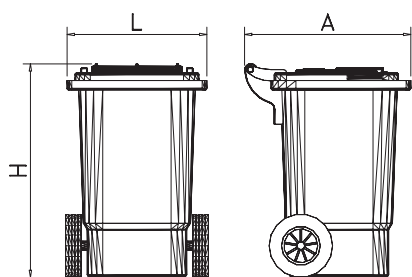

L	A	H	D	It	Kg	€
						486002
						486042
470	550	670		60 lts	8,75	486038 77,00
						486040
						486044
						486034
470	550	925		120 lts	10,50	486032 82,00
						486036
						486030
						486084
580	740	1.070		240 lts	14,50	486082 154,00
						486086
						486080

Características:

Ampliamente resistentes al calentamiento, a las heladas y a los productos químicos.

Characteristics:

Highly resistant to heat, extreme cold and chemical products.

Caractéristiques:

Très résistant aux hautes températures, aux gelées et aux produits chimiques.

It	€
Pedal opcional Optional pedal Pédale en option	60 lts 486050 26,00
Pedal opcional Optional pedal Pédale en option	120 lts 486060 27,00



L	A	It	Gr	€
				486090
				486091
470	550	60 lts	230	486092 25,00
		120 lts		486093
				486094
				486120
				486122
580	740	240 lts	300	486124 33,00
				486126
				486128



Novedad
new
nouveau

L	It	Gr	€
	60 lts		
	120 lts	680	486096 20,00
	240 lts		
460	60 lts	110	486097 20,00
	120 lts		
550	240 lts	150	486098 25,00



El precio es por pareja.
The pair is included in the price.
Le paire est inclus dans de prix.

Contenedor inoxidable con tapa

Stainless container with lid
Conteneur inoxydable avec couvercle

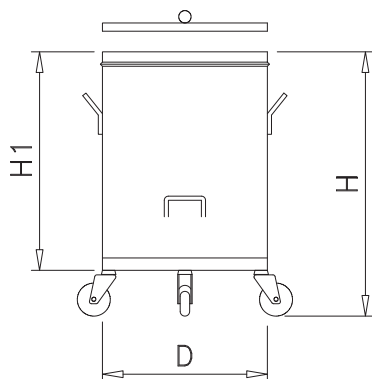

Características:

Construido totalmente en acero inoxidable AISI 304. Esquinas interiores redondeadas para favorecer la limpieza. Ruedas pivotantes para facilitar el desplazamiento.

Characteristics:

Made entirely out of AISI 304 stainless steel. With pivoting wheels for easy movement. Interior bends to favour its cleaning.

Caractéristiques:

Entièrement construit en acier inoxydable AISI 304. Equipé de roues pivotantes pour faciliter les déplacements. Courbures intérieures pour favoriser son nettoyage.

H	H1	D				€
600	530	400	60 lts	7,10	486004	247,00

Contenedor inoxidable con tapa de apertura a pedal

Pedal operated stainless container with lid
Conteneur inoxydable avec couvercle à pédale

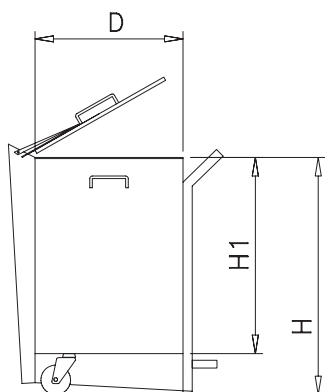

Características:

Construido totalmente en acero inoxidable AISI 304. Esquinas interiores redondeadas para favorecer la limpieza. Ruedas pivotantes para facilitar el desplazamiento. Apertura a pedal.

Characteristics:

Made entirely out of AISI 304 stainless steel. With pivoting wheels for easy movement. Interior bends to favour its cleaning. Pedal-operated cover.

Caractéristiques:

Entièrement construit en acier inoxydable AISI 304. Equipé de roues pivotantes pour faciliter les déplacements. Courbures intérieures pour favoriser son nettoyage. Ouverture du couvercle par pédale.

H	H1	D				€
605	530	400	60 lts	12,25	486006	390,00

Contenedor porta-bolsas con tapa y ruedas

Bag-holder container with lid and wheels
Conteneur porte-sacs avec couvercle et rouelles

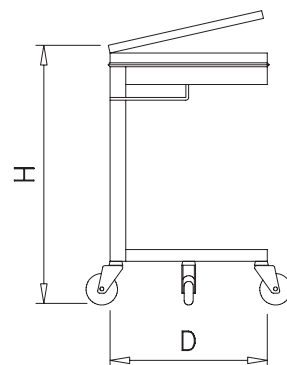

D	H			€
430	900	3,25	486010	255,00

Contenedor porta-bolsas sistema "tijera", apertura a pedal

Pedal operated folding system bag-holder container
Conteneur porte sacs système pliant à pédale

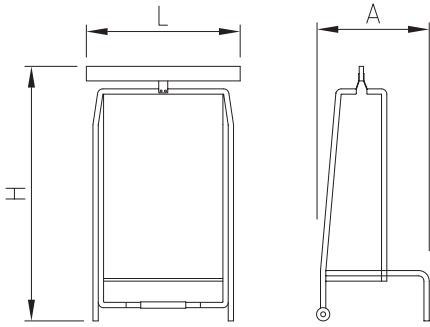

L	A	H	Kg	Barcode	€
470	570	1.000	6,65	486020	155,00



Contenedor inoxidable con tapa y ruedas especial panadería

Stainless steel dustbin with lid and wheels. Special for bakery
Poubelle inoxydable avec couvercle et rouelles. Spécial pour boulangerie

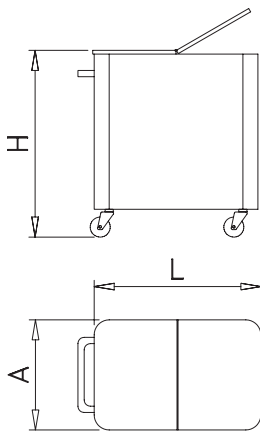

L	A	H	lit	Kg	Barcode	€
725	437	727	170	19,00	486008	690,00



Papelera con tapa y ruedas 70 lt

Container with lid and wheels 70 l.
Poubelle avec couvercle et roulettes 70 lt

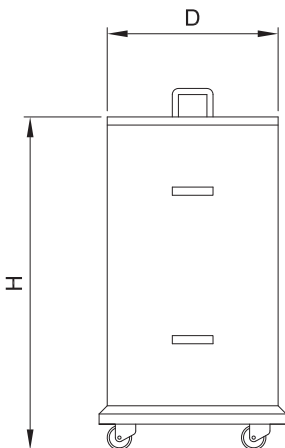

Características:

Fabricada en acero inoxidable acabado brillo.

Characteristics:

Made out of stainless steel, polished finishing.

Caractéristiques:

Fabriquée en acier inoxydable finition brillante.

D	H	lit	Kg	Barcode	€
420	730	70	10,50	486076	210,00



Contenedor inox para vaciado de bandejas de comida rápida

Stainless steel waste bin for fast-food tray's emptying
Poubelle en acier inoxydable spéciale snack restauration rapide



Apertura a pedal
Foot pedal opening
Ouverture à pédale

Patentado
Patented
Breveté



Características de fabricación:

Fabricado totalmente con acero inoxidable.
Sistema patentado de pedal. Permitirá al usuario abrir la trampilla sin necesidad de usar las manos. La trampilla también se puede abrir con la mano en caso de requerirlo.
Las varillas de la parte superior del mueble facilitan la colocación de las bandejas.
La tolva de caída de los desperdicios es de una sola pieza y no posee juntas ni huecos, lo que facilita la limpieza.
Asa de la puerta ergonómica.
El contenedor posee dos ruedas, lo que permite desplazarlo con poco esfuerzo.
Provisto de dos tacos regulables en altura para adaptarse a cualquier clase de suelo, evitando desplazamientos accidentales o no deseados.
Insonorizado en todas sus piezas.

Manufacturing characteristics:

Wholly made of stainless steel.
Pedal operated patented system. It will allow the user to open the lid avoiding the use of his hands. The lid can also be opened with the hand if necessary.
Rods on the top that make easier the placing of the empty trays.
Receptacle for scraps made in one only piece, without joints or hollows.
Ergonomic handle.
It can be moved effortlessly by means of two wheels.
It can be adapted to any floor unevenness thanks to two adjustable blocks.
All its components are soundproofed.



480662 21,00

Adhesivo trampilla
Sticker for lid
Autocollant pour trappe



486022 27,00 368

Contenedor de desperdicios 95 lts
Waste bin 95 lts
Conteneur à ordures 95 lts



486074 31,00 377

Contenedor de plástico con tapa
55 lts
Plastic bin with lid 55 lts
Conteneur 55 lts



480664 21,00

Adhesivo para pedal
Sticker for pedal
Autocollant pour pédale



485024 31,00

Ruedas
Wheels
Rouelles



Caractéristiques de fabrication:

Fabricado totalmente en acero inoxidable.
Système patenté de pédale. Permettra à l'utilisateur ouvrir la trappe sans avoir besoin d'utiliser les mains. La trappe peut aussi être ouverte avec les mains.
Les tiges de la partie supérieure du meuble facilitent le rangement des plateaux.
La trémie de déchets est construite dans une seule pièce et elle ne possède pas de joints, ce qui facilite le nettoyage.
Tireur ergonomique.
La poubelle a deux rouelles, ce qui permet de le déplacer sans effort.
Elle est pourvue de deux vérins réglables en hauteur pour s'adapter au plancher.
Toute la poubelle est insonorisée.

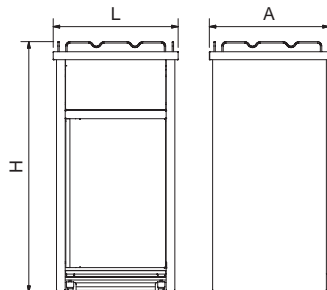

Incluido / Included / Inclus
Opcional / Optional / Optionnel



L	A	H	Kg	Barcode	€
625	600	1.255	46,0	080660	995,00
540	410	1.016	30,5	080662	900,00

Mesa mural desbarasado y reciclaje con puerta

Waste and recycling wall-side table
Table murale pour trémie à déchets et recyclage

Características:

Laterales y trasera forrados en acero inoxidable.
Aro para tolva de desbarasado color azul.
Tapa para aro.

Characteristics:

Sides and bottom lined in stainless steel.
Blue ring for waste chutes.
Ring lid.

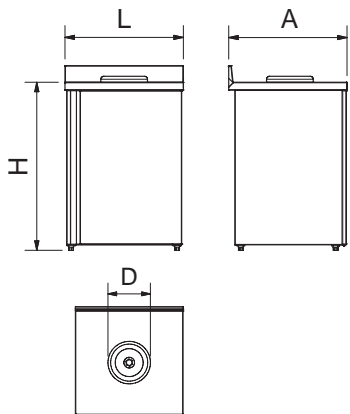

Caractéristiques:

Latérales et fond recouvertes en acier inoxydable.
Cercle bleu pour trémies à déchets.
Couvercle.



(Inc) Incluido / Included / Inclus

(Op) Opcional / Optional / Optionnel

L	A	H	D	Kg	Barcode	€
600	600	850	235	23	074438	630,00
600	700	850	235	28	074437	790,00

Contenedor de desperdicios y reciclaje

Waste and recycling container
Conteneur à ordures et recyclage

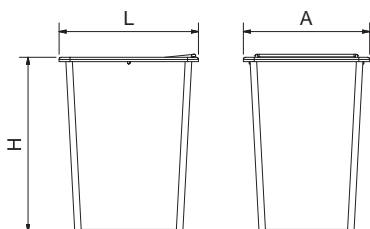

L	A	H	lit	Gr	Barcode	€
315	285	380	26	400	486024	18,00
					486026	
					486028	
					486025	

Centro de reciclado 4 elementos

4 elements recycler
Centre de recyclage de quatre éléments

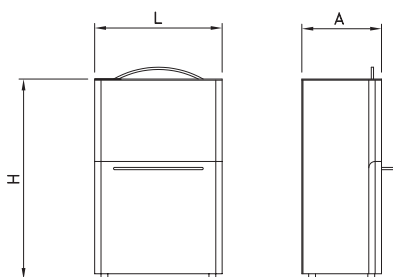

L	A	H	lit	Kg	Barcode	€
560	350	880	72	18,0	486068	600,00

Contenedor de reciclaje vertical

Vertical recycling waste bin
Conteneur de recyclage vertical



Wholly made in stainless steel AISI 304, it has been designed for a selective collection of waste products. Its column-shape design allows you to get a better use of space in working areas.

It is composed of a front door with four lids provided with an automatic shutting that leads to the different inner containers.

Total capacity of 104 litres divided into four tight compartments of 26 litres each one.

With declined roof to avoid dirtiness deposits. Its free space underneath enables an easy cleaning.

Originally it is designed to lodge different kind of waste products:

- Paper and paperboard.
- Cans and plastic containers.
- Glass bottles
- Trash.

Later on you will be able to make your own configuration by means of the rubber ring for wastes and stickers available according to the products you need to recycle.

Faites entièrement en acier inox AISI 304, il a été conçu pour une collecte sélective des déchets. Dessiné en forme de colonne pour une meilleure utilisation de l'espace dans les zones de travail.

Porte frontale avec quatre trappes munies de fermeture automatique. Chaque trappe donne accès à un conteneur différent.

Capacité totale de 104 litres divisé en quatre compartiments de 26 litres chacun.

Avec toit incliné pour éviter les dépôts de saleté. Son espace libre en dessous permet un nettoyage facile.

A l'origine il est destiné à loger des différents types de déchets:

- Papiers et cartons.
- Récipient en plastique.
- Bouteilles en verre
- Des ordures.

Postérieurement vous pourrez faire votre propre configuration à l'aide de la bague en caoutchouc pour les déchets et les autocollants disponibles selon les produits dont vous avez besoin de recycler.

Recipientes interiores estancos, independientes y extraíbles de 26 lts de capacidad fabricados en plástico 100 % reciclable. Disponen de asas para su fácil manipulación.

It is provided with detachable tight containers of 26 litres of capacity, made in plastic 100% recyclable and with handles for an easy handling.

Il est fourni avec conteneurs étanches détachables de 26 litres de capacité, fabriqués en plastique 100% recyclables et avec des poignées pour une manipulation facile.

- Includido / Included / Inclus
 Opcional / Optional / Optionnel

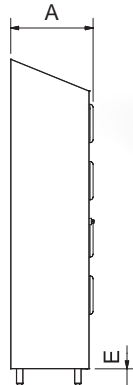

Gestione sus residuos de una manera eficaz, ocupando el menor espacio posible.

Su construcción en acero inoxidable permite su ubicación en exteriores.

Ideal en cocinas, vestuarios, oficinas, instalaciones deportivas, etc.

Arrange your waste products with efficiency and optimize room.

It is made in stainless steel, which allows to be installed at any outdoor space.

Ideal for kitchens, dressing-rooms, offices, sport facilities, etc.

Organisez vos déchets avec efficacité et optimisez votre espace.

Il est fabriqué en acier inoxydable, ce qui permet son installation à tout espace extérieur.

Idéal pour salles de cuisines, dressing-rooms, bureaux, installations sportives, etc.

Armario fabricado totalmente en acero inoxidable, concebido para la recogida selectiva de residuos. Mejor aprovechamiento del espacio en el entorno de trabajo gracias a su diseño en modo de columna.

Formado por una puerta frontal con cuatro trampillas provistas de cierre automático, que dan acceso a los diferentes contenedores interiores.

104 litros de capacidad total repartida en cuatro contenedores de 26 lts cada uno.

Techo inclinado para evitar depósitos de suciedad, el espacio inferior libre permite limpiar debajo del mueble.

En su configuración estándar está preparado para reciclar:

- Papel y cartón.
- Envases.
- Materia orgánica, basura general.
- Vidrio.

Posteriormente usted podrá personalizar su contenedor mediante aros y adhesivos en función de los residuos que desee reciclar.











L	A	H	E			€
370	505	2.010	120	33	081440	875,00

Repuestos para contenedor de reciclaje vertical

Spare parts for vertical recycling waste bin

Pièces de remplacement pour conteneur de recyclage vertical

	Gr	Barcode	€
			481420 25,00
			481422 25,00
			481424 25,00
			481426 25,00
			481428 25,00
	750	081442	43,00
	750	081444	43,00
	750	081446	43,00
	750	081448	43,00

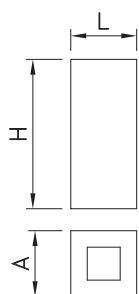

L	A	H	It	Kg	Barcode	€
300	300	680	58 lts	6,8	486102	
					486104	
					486106	225,00
					486108	
					486110	

Papelera de reciclaje con tapa basculante

Recycling bin with swing lid

Poubelle de recyclage avec couvercle basculant



Novedad
SW
Niveau

Contenedor para reciclado

Recycling container
Récipient pour le recyclage

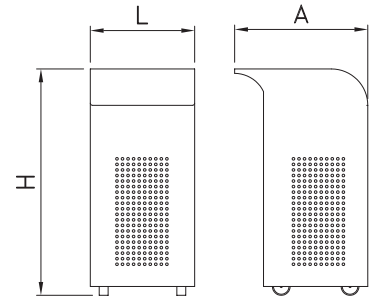

L	A	H	lit	Kg	€
470	600	1.020	270 lts.	28,0	960,00
					486062
					486064
					486066

Papelera inox de 70 lt apertura frontal

Inox wastepaper bin 70 litres, front opening
Corbeille à papier inox 70 litres, ouverture frontale

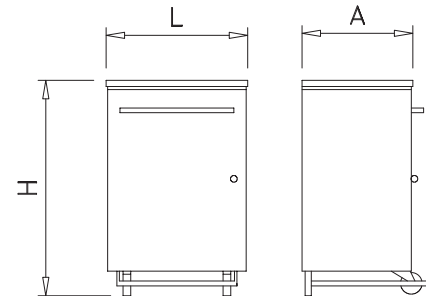

L	A	H	Kg	€
460	360	700	7,0	348,00

Papelera basculante en acero inoxidable

Stainless steel toggling wastebin
Conteneur basculant en acier inox



Características:

Construida totalmente en acero inoxidable.
Fácil apertura para su carga y descarga, tan solo levantando su caperuza superior.

Characteristics:

Totally made in stainless steel. Easy opening for charge and discharge, by only lifting the upper cover.

Caractéristiques:

Fait tout en acier inox. Facile ouverture pour le charger et le décharger, seulement en levant le couvercle supérieur.

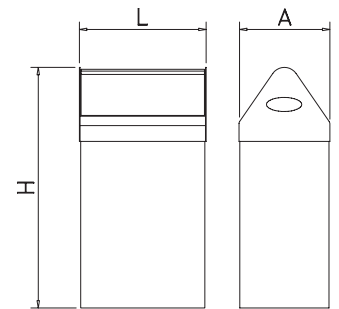

Apertura Opening Ouverture	L	A	H	lit	Kg	€
Manual Manual Manuel	350	250	680	44 lts	6,85	080604 263,00
Pedal opcional Optional pedal Pédale optionel					0,4	080606 42,00

Repuestos para contenedores inoxidables

Spares for inox-dustbin
Rechangements pour poubelles

	Modelos Models Modèles	Gr	€
	486004	120	486052 6,00
	486006		
	486008	30	486054 6,00
		50	486058 6,00
	486010	35	486056 7,00

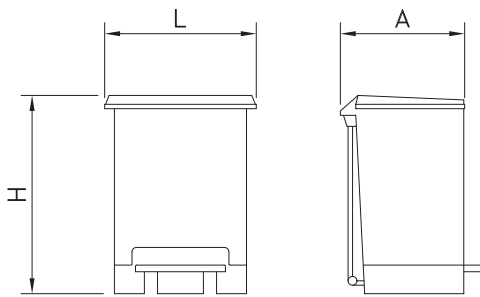

L	A	H	lt	Kg	Barcode	€
330	270	450	26	1,80	486072	18,70

Papelera de plástico con pedal
Plastic bin with pedal
Poubelle en plastique avec pédale



Contenedor higiénico sanitario con apertura a pedal
Pedal operated sanitary bin
Poubelle hygiénique sanitaire à pédale

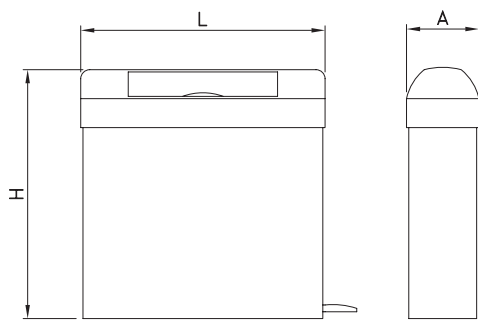

L	A	H	lt	Kg	Barcode	€
540	160	550	23	6,85	460248	92,00

Características:

Unidad diseñada exclusivamente para la recogida de residuos como compresas, tampones y pañales. Construidos en ABS color blanco, cuentan con pedal y tapa basculante integrados, además de cabezal reversible.

Characteristics:

Specially designed for waste collection such as pads, tampons and diapers. Made of white ABS, with integrated pedal, swing top lid and masking tray.

Caractéristiques:

Spécialement conçu pour la collecte des déchets tels que tampons, serviettes-hygiéniques et couches. Fabriqué en ABS blanc, avec pédale intégrée, couvercle pivotant supérieur et vanne de masquage.



Contenedor de plástico con tapa 55 litros
Plastic bin with lid 55 Litre
Conteneur 55 lts

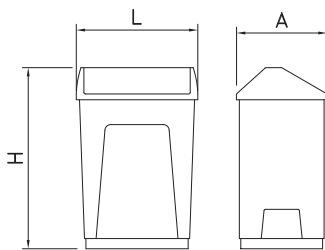

L	A	H	lt	Kg	Barcode	€
415	320	620	55	3,0	486074	31,00



Cubo pedal baño con papelera interior
Pedal bin
Poubelle sale de bains

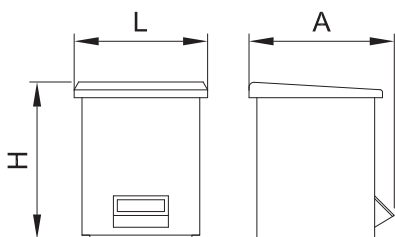

L	A	H	lt	Gr	Barcode	€
270	230	280	8	809	486112	18,00



Papelera

Wastepaper bin
Corbeille à papiers



Características:

Admite colocación mural o de sobremesa. Por sus dimensiones y diseño es ideal para bares, cafeterías, etc. Al estar construida totalmente en acero inoxidable es válida para exteriores.

Characteristics:

It allows its placing on table or on wall. For its dimensions and design it is ideal for bars, cafeterias, etc. Because of its whole construction on stainless steel it is valid for outdoors.

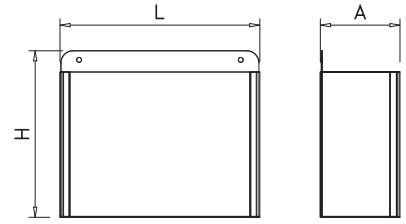

Caractéristiques:

Elle admet d'être placé sur table ou sur mur. Par ses dimensions et dessin c'est idéale pour bars, cafés, etc. Comme c'est construit totalement en acier inoxydable, c'est valide pour extérieurs.

L	A	H	lit	Kg	Barcode	€
330	130	275	11 lts	2,20	080602	58,00

Papelera modelo Design

Design model wastepaper bin
Corbeille à papiers modèle Dèsign



Características:

Admite colocación mural o de sobremesa. Por sus dimensiones y diseño es ideal para bares, cafeterías, etc. Al estar construida totalmente en acero inoxidable es válida para exteriores.

Characteristics:

It allows its placing on table or on wall. For its dimensions and design it is ideal for bars, cafeterias, etc. Because of its whole construction on stainless steel it is valid for outdoors.

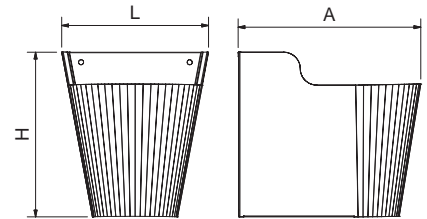

Caractéristiques:

Elle admet d'être placé sur table ou sur mur. Par ses dimensions et dessin c'est idéale pour bars, cafés, etc. Comme c'est construit totalement en acier inoxydable, c'est valide pour extérieurs.

L	A	H	lit	Kg	Barcode	€
340	265	300	18 lts	2,3	080608	68,00

Papelera con tapa y pedal

Pedal operated wastepaper bin with lid
Corbeille à papiers avec couvercle et pédale

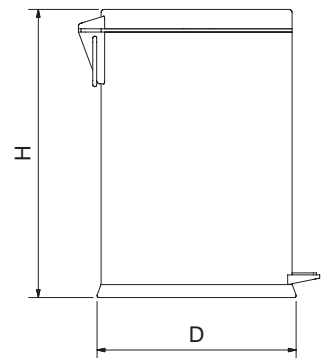

D	H	lit	Kg	Barcode	€
200	310	5 lts	2,0	486012	27,00
250	390	12 lts	3,9	486014	39,00
260	730	30 lts	5,9	486016	70,00

Dispensador de bolsas

Whole dispenser for plastic bags
Conjoint dispensateur de sacs

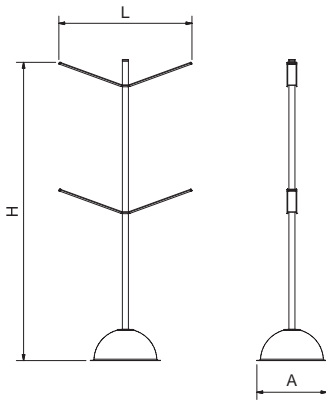

L	A	H	Kg	Barcode	€
550	290	1.245	9,0	080426	165,00



Conjunto dispensador de guantes y bolsas en rollo

Whole gloves and plastic roll bags dispenser
Conjoint dispensateur de gants et sacs en roulot

Características:

El conjunto y sus complementos cumplen con toda la normativa aplicable al respecto de la Unión Europea. Dispensador de guantes que, por separado, admite colocación de sobremesa. Dispensador de bolsas de hasta 370 mm. de longitud, semi-hermético, que, por separado, admite colocación a pared. Soporte para dispensadores y papeleras, construido específicamente para favorecer la estabilidad y la higiene.

Characteristics:

The whole and its items obey with all the applicable norms from the European Union and the Spanish state. Gloves dispenser, that separately, it admits to be put in table. Plastic bags dispenser of 370 length maximum, semi-hermetic, that separately it admits to be put in wall. Dispensers and wastebins support, made specifically to improve the stability and the hygiene. Wastebin. Totaly made in stainless steel.

Caractéristiques:

Le conjoint et ses compléments obéissent avec les norms applicables de la Union Européenne et l'Etat Espagnol. Dispensateur de gants, que par séparé, admet d'être placé sur table. Dispensateur de sacs jusqu'à 370 mm de longueur, semi-hermétique, que par séparé, admet d'être placé sur mur. Support pour dispensateurs et conteneurs, fait spécifiquement pour favoriser l'estabilité et l'hygiène.

L	A	H	Kg	Barcode	€
422	490	1.290	9,6	080402	278,00

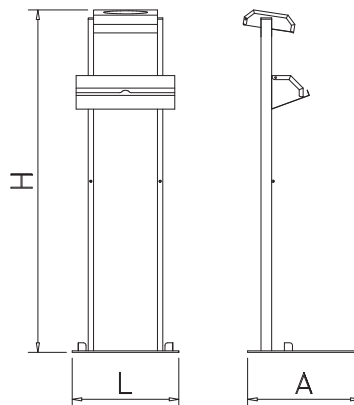

Conjunto dispensador de guantes y bolsas colgantes

Whole dispenser for gloves and hanging plastic bags
Conjoint dispensateur de gants et sacs suspendus

Características:

El conjunto y sus complementos cumplen con toda la normativa aplicable al respecto de la Unión Europea y del Estado Español.

Dispensador de guantes que por separado, admite colocación de sobremesa. Soporte para dispensadores y papeleras, construido específicamente para favorecer la estabilidad y la higiene.

Characteristics:

The whole and its items obey with all the applicable norms from the European Union and the Spanish state. Gloves dispenser, that separately, it admits to be put in table. Dispensers and wastebins support, made specifically to improve the stability and the hygiene.

Caractéristiques:

Le conjoint et ses compléments obéissent avec les norms applicables de la Union Européenne et l'Etat Espagnol. Dispensateur de gants, que par séparé, admet d'être placé sur table. Support pour dispensateurs et conteneurs, fait spécifiquement pour favoriser l'estabilité et l'hygiène.

L	A	H	Kg	Barcode	€
422	490	1.290	8,5	080412	244,00

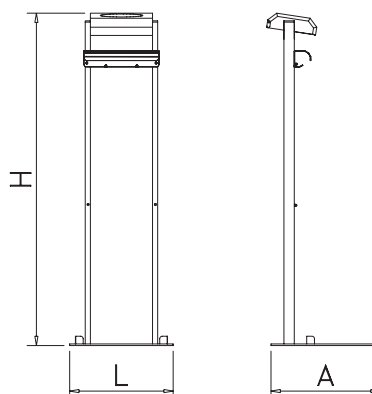

Conjuntos dispensadores de guantes y bolsas con papeleras

Whole gloves and plastic bags dispensers with wastebins
Conjoints dispensateurs de gants et sacs avec conteneurs



€	
Con papelera adosada With joint wastebin Avec conteneur adossé	336,00



Apertura Opening Ouverture		€
Con papelera basculante With toggling wastebin Avec conteneur basculant	Manual Manuel	541,00
	Con pedal With pedal Avec pédale	583,00



€	
Con papelera adosada With joint wastebin Avec conteneur adossé	302,00



Apertura Opening Ouverture		€
Con papelera basculante With toggling wastebin Avec conteneur basculant	Manual Manuel	507,00
	Con pedal With pedal Avec pédale	549,00

Dispensador de guantes

Gloves dispenser
Distributeur de gants



Características:

Construidos totalmente en acero inoxidable acabado satinado. La colocación del dispensador puede ser mural o de sobremesa. Como dotación estándar cuentan con tacos antideslizantes para su colocación de sobremesa.

Characteristics:

Made out totally of stainless steel. The placing of both may be on table or on wall. As standard equipment they have anti-slipping pegs for its placing on table.

Caractéristiques:

Construit totalement en acier inoxydable brillant. Comme équipement standar ils ont ventouses anti-glissants pour se placement sur table.

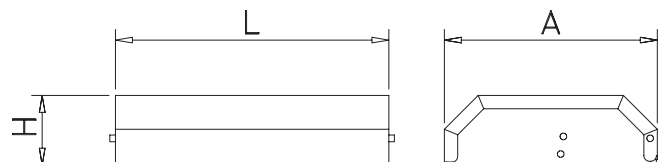

L	A	H	Gr	Barcode	€
270	195	65	900	080404	55,00

Dispensador de bolsas en rollo

Roll bag dispenser
Distributeur de sacs sur rouleau

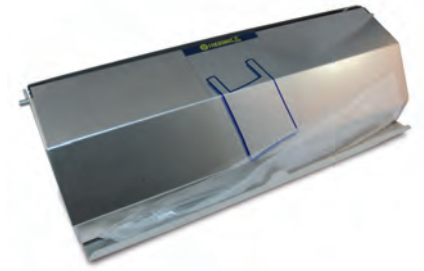
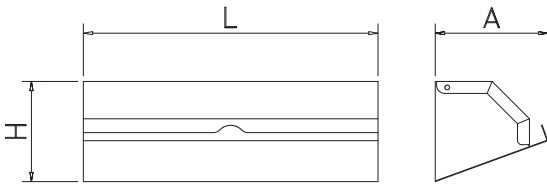

L	A	H	Kg	Barcode	€
375	140	125	1,25	080406	60,00

Dispensador de bolsas colgantes

Hanging bags dispenser
Distributeur de sacs suspendus

Características:

Distancia entre ejes regulable, para adaptarse a cualquier medida entre taladros de la bolsa.

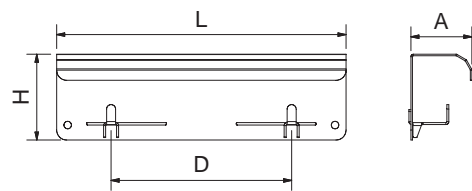

Characteristics:

Adjustable axle distance to adapt any measure between the bag holes.

Caractéristiques:

Distance entre axes réglable afin de s'adapter à quelque mesure entre les trous du sac.

L	A	H	D	Kg	Barcode	€
290	61	86	90-215	0,51	080414	26,00

Dispensador mural de papel alimentario

Food paper wall dispenser
Dispensateur mural de papier alimentaire

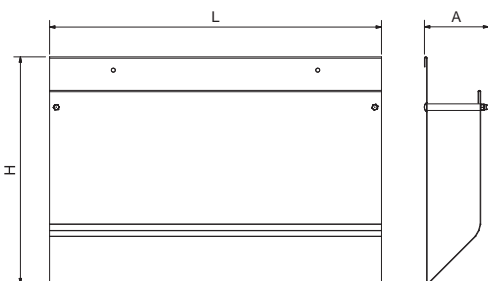

L	A	H	Kg	Barcode	€
500	85	342	2,33	080410	72,00

Papelera-dispensador de bolsas de papel

Wastepaper bin and paper bags dispenser
Corbeille a papiers et distributeur de sacs en papier

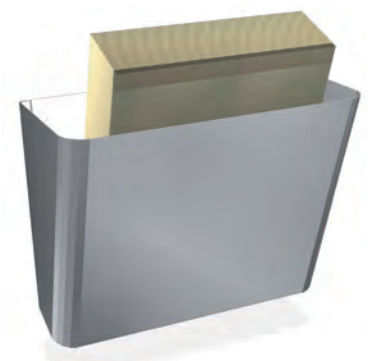
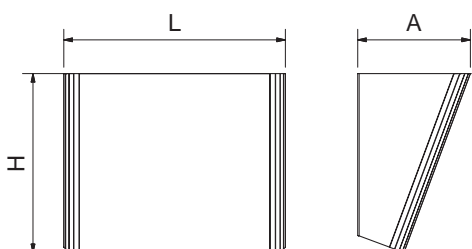

L	A	H	Kg	Barcode	€
315	160	245	1,72	080424	65,00

Dispensadores de bobinas para envolver

Dispenser for rolls of wrapping material
Dévidoirs de rouleaux pour protéger les aliments

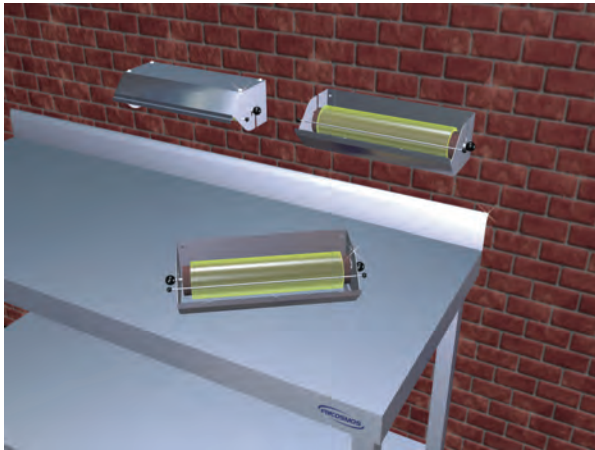

Caractéristiques:

Fabriqués en acier inoxydable, pouvant être placés suivant les trois manières indiquées acuteau, munis d'une lame à dents spéciales pour faciliter la coupe du film ou du papier d'aluminium.

Características:

Construidos en acero inoxidable. Válido para colocarse de las tres maneras al lado representadas. Provisto de filo dentado especial para favorecer el corte del film o papel de aluminio.

Characteristics:

Manufactured from stainless steel, apt for positioning in the three manners demonstrated besides, equipped with a special serrated blade for cutting plastic film or aluminium foil.

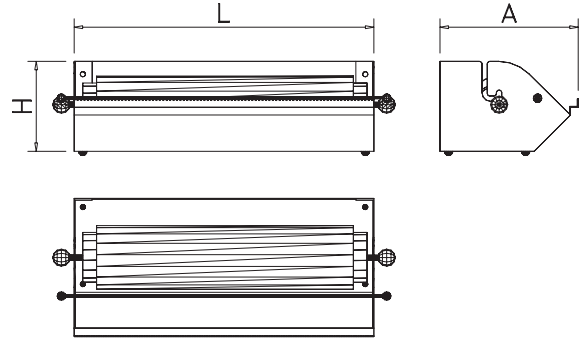

L	A	H	Largo de bobina Roll lenght Longeur du rouleaux	Kg	Barcode	€
350	165	110	300	0,95	080202	60,00
500	165	110	450	1,35	080204	66,00

Kits de portarrollos de papel o film

Paper or film roll holder kit
Kit de porte-rouleaux du papier ou film

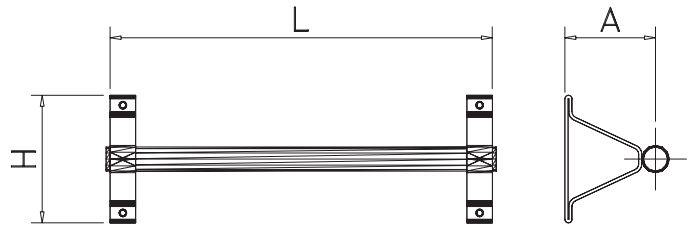
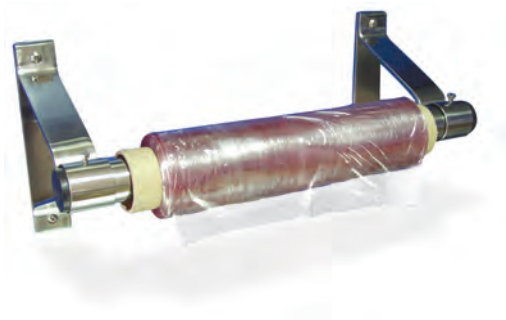

L	A	H	Largo de bobina Roll lenght Longeur du rouleaux	Kg	Barcode	€
450	150	200	300	2,1	080206	194,00
600	150	200	450	2,2	080208	198,00
750	150	200	600	2,3	080210	207,00
1.050	150	200	900	2,6	080212	212,00

Kits de portarrollos de papel o film serie Eco

Eco serie paper or film roll holder kit
Kit de porte-rouleaux du papier ou film serie Eco

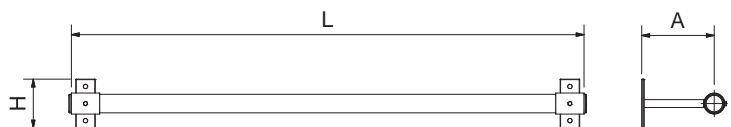

L	A	H	Largo de bobina Roll lenght Longeur du rouleaux	Kg	Barcode	€
450	150	200	300	1,39	080220	113,00
600	150	200	450	1,59	080222	116,00
750	150	200	600	1,80	080224	119,00
1.050	150	200	900	2,21	080226	122,00

Dispensador de tissues, guantes, toallas, etc.
Tissues, towels, gloves dispenser
Dispensateur de tissues, essuie-mains, gants, etc.

Para cajas de medidas Admisse box of dimensions Dimensions		
l	a	h
230	120	70

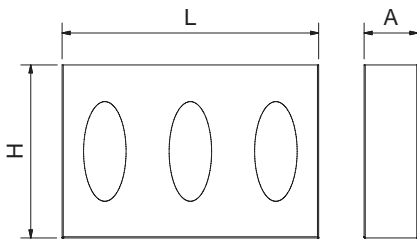
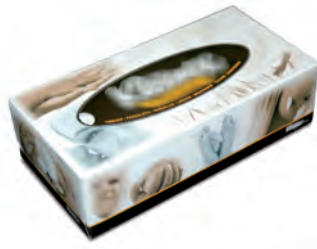

L	A	H		Kg		€
130	80	260	1	0,9	080418	15,00
386	80	260	3	2,1	080420	25,00

Consumibles para dispensadores
Spare accessories for dispensers
Accessoires de rechange pour dispensateurs



Bolsas colgantes 350x450
Pending bags 350x450 mm
Sacs pendants 350x450 mm

500 480052 **9,00**



Bolsas en rollo 350x450
Rolle bags 350x450
Sacs en roulot 350x450 mm

500 480050 **11,00**

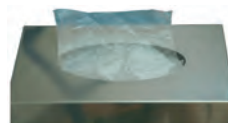

Guantes
Gloves
Gants

500 480054 **3,50**



Bobina de film transparente uso alimentario
Transparent film roll for food use
Rouleaux de film transparent pour usage alimentaire

Ø 90x300 mm 300 m 480056 **9,50**

Ø 90x450 mm 300 m 480058 **12,50**

Ø 120x600 mm 1500 m 480060 **75,00**

Ø 120x900 mm 1500 m 480062 **120,00**

Barra de apoyo mural para lavabo

Wall-side support bar for washbasin
Barre d'appui murale pour lavabo

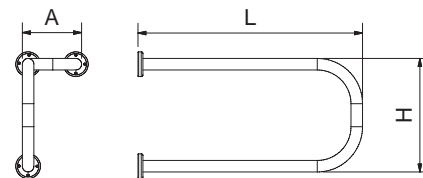

L	A	H	Kg	Barcode	€
---	---	---	----	---------	---



600	155	310	1,5	481654	170,00
-----	-----	-----	-----	--------	--------

Barra de apoyo mural para bañera

Wall-side support bar for bath
Barre d'appui murale pour baignoire

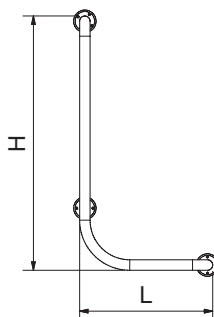

L	H	Kg	Barcode	€
---	---	----	---------	---

380	780	1,33	481658	102,00
-----	-----	------	--------	--------

Barra de apoyo mural vertical

Vertical wall-side support bar
Barre d'appui murale vertical

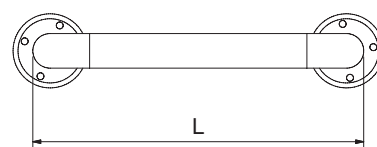

L	Gr	Barcode	€
---	----	---------	---

295	450	481660	33,00
-----	-----	--------	-------

610	600	481662	43,00
-----	-----	--------	-------

915	900	481664	46,00
-----	-----	--------	-------

Barra de apoyo mural vertical abatible

Vertical wall-side hinged support bar
Barre d'appui murale verticale battante

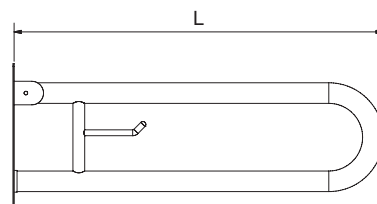
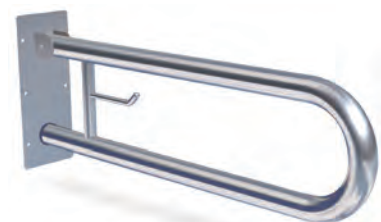

L	Kg	Barcode	€
---	----	---------	---

600	2,35	481666	137,00
-----	------	--------	--------

795	2,68	481668	141,00
-----	------	--------	--------

Barra de apoyo abatible. Anclaje a suelo

Floor-mounted hinged support bar
Barre d'appui battante ancrage au sol

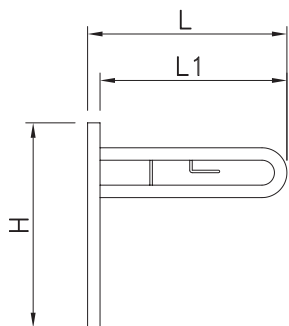

L	H	L1	Kg	Barcode	€
800	820	750	2,90	481670	260,00



Barra de apoyo mural horizontal

Horizontal wall-side support bar
Barre d'appui murale horizontale

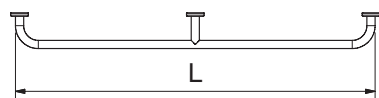

L	Kg	Barcode	€
1.220	1,66	481650	94,00



Barra de apoyo mural horizontal pasamanos

Horizontal wall-side handrail support bar
Barre d'appui murale horizontale main courante

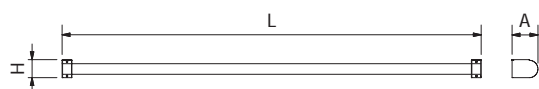

L	A	H	Kg	Barcode	€
2.000	93	65	3,75	083202	65,00



Asiento abatible

Hinged seat
Siège abattable

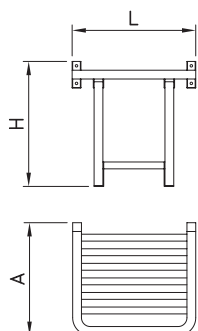

L	A	H	Kg	Barcode	€
450	410	455	3,20	481672	236,00



Lavaojos mural de emergencia en acero inoxidable

Stainless steel wall-mounted emergency eyes-bath
Lave-yeux mural d'urgence en acier inoxydable

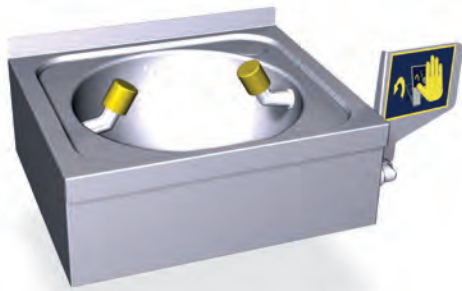

Novedad
ew
nouveau



Con cada aparato, se entrega un rótulo para señalar la unidad.

Every appliance is delivered with a label to mark the unit.
Chaque appareil c'est fourni avec une étiquette pour marquer l'unité.

Características:

Los lavaojos de emergencia ofrecen instantáneamente agua como primera ayuda.

Los lavaojos con dos rociadores y recogedor en ACERO INOXIDABLE, ofrecen un gran caudal de agua aireada a baja presión, que baña la cara y los ojos, sin dañar los delicados tejidos oculares.

Characteristics:

Our emergency eyes baths offers you an instantly first aid of water.

Our eye baths, with twin sprayer and stainless steel bowl provide a high flow of low pressure aired water that washes face and eyes without any damage for the delicate eyes tissue.

Caractéristiques:

Nos lave-yeux muraux d'urgence vous offre une aide instantané d'eau.

Nos lave-yeux, avec deux têtes d'aspersion et avec vasque en acier inoxydable, procurent un grand débit d'eau airée à basse pression pour le lavage des yeux et du visage sans endommager les sensibles tissus oculaires.

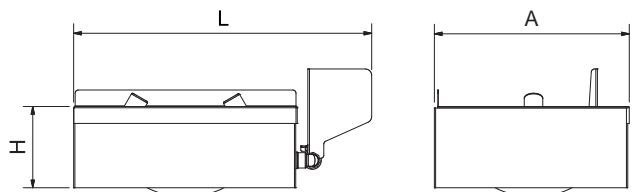

L	A	H	Kg	Barcode	€
469	305	127	5,0	064620	319,00

Ducha mural de emergencia

Wall-mounted emergency shower
Douche d'urgence murale



Novedad
ew
nouveau



Con cada aparato, se entrega un rótulo para señalar la unidad.

Every appliance is delivered with a label to mark the unit.
Chaque appareil c'est fourni avec une étiquette pour marquer l'unité.

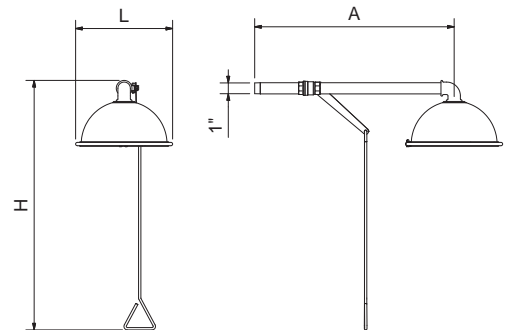

L	A	H	Kg	Barcode	€
294	605	756	2,6	064630	192,00

Lavabotas

Boot washer
Lave bottes

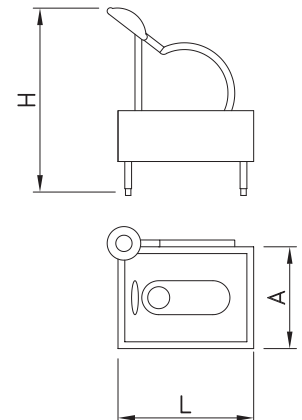
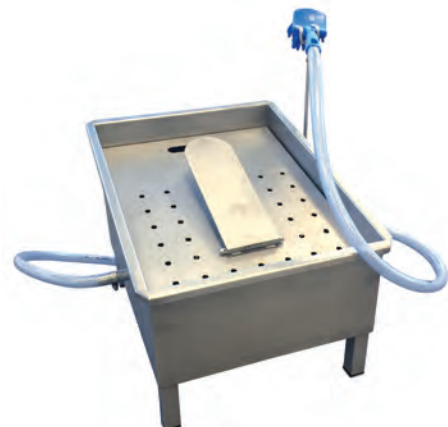

L	A	H	Kg	Barcode	€
550	445	590	11,0	460260	975,00

Armario botiquín
 Medicine chest
 Armoire à pharmacie

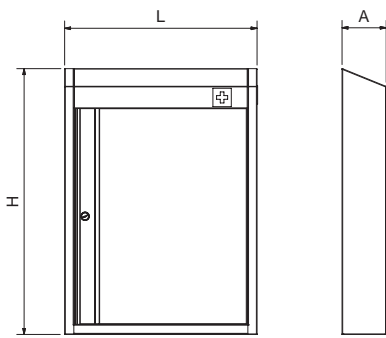

L	A	H	Kg	Barcode	€
523	120	723	9,00	080830	350,00

Indicador de suelo mojado
 Display wet floor
 Affiche sol humide

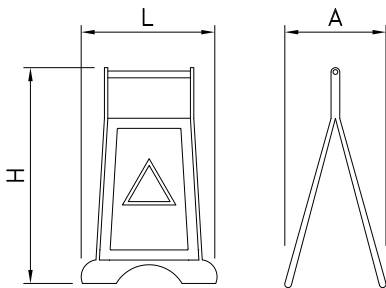

L	A	H	Gr	Barcode	€
290	300	600	400	465622	14,00

Carro de limpieza
 Cleaning cart
 Panier à nettoyage

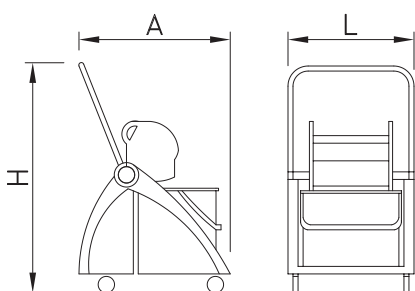

L	A	H	Kg	Barcode	€
600	500	900	8,90	465620	286,00

Espátula plástica, metal detectable
 Plastic spatula, metal detectable
 Spatule plastique, métal détectable, rouge

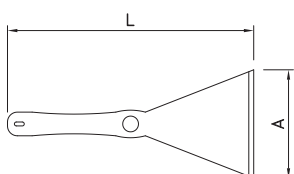

L	A	Gr	Barcode	€
250	110	110	482024	15,00

Espátula de plástico antiestático

Antistatic plastic spatula
Spatule en plastique antistatique



Novedad
ew
ouveau

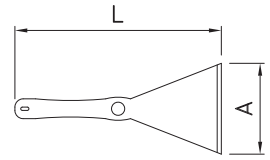

L	H	Gr	Barcode	€
110	50	110	482044	41,00

Rasqueta antiestática flexible para masa sin agujero

Antistatic flexible dough scraper without hole
Grattoir antistatique flexible pour surface sans trous



Novedad
ew
ouveau

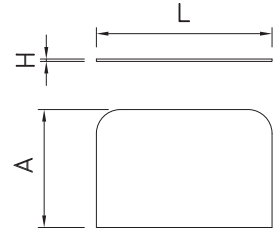

L	A	H	Gr	Barcode	€
145	98	1,65	40	482038	15,00

Cepillo + palo polipropileno alimentario

Broom and stick in polypropylene for food use
Balai et manche en polypropylène pour usage alimentaire

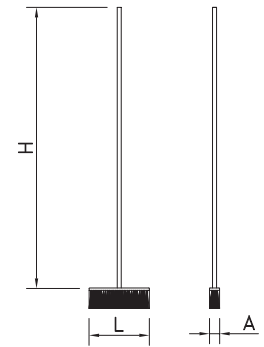

L	A	H	Gr	Barcode	€
300	50	1.500	250	482020	75,00

Cepillo de barrer suave antiestático

Antistatic sweeping brush with soft bristles
Brosse à balai antistatique doux



Novedad
ew
ouveau

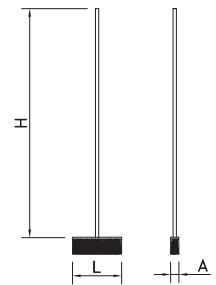

L	A	H	Gr	Barcode	€
280	48	1.500	300	482028	356,00

Cepillo de mano multiusos metal detectable

Multipurpose handheld brush, metal detectable
Brosse à main multi usage métal détectable

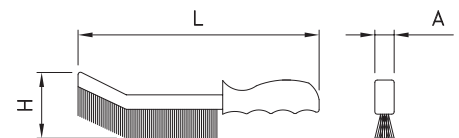

L	A	H	Gr	Barcode	€
410	55	60	270	482022	43,00

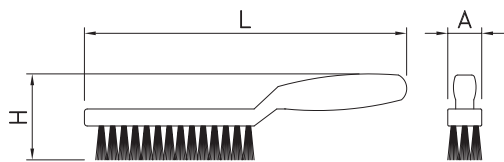

L	H	Gr	Barcode	€
275	20	180	482042	70,00

Cepillo antiestático estrecho para maquinaria

Narrow antistatic brush for machinery
Brosse antistatique étroite pour machines



Novedad
New
nouveau

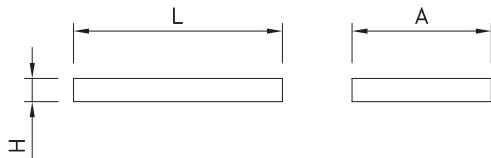

L	A	H	Gr	Barcode	€
135	90	15	48	482026	6,50

Juego de 4 esponjas de colores

4 piece sponge set - different colors
Set de 4 éponges de couleurs



Pala antiestática de mano

Antistatic hand shovel
Pelle antistatique de main

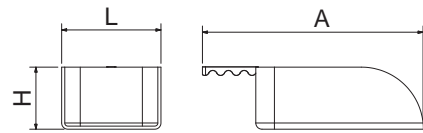

L	A	H	Gr	Barcode	€
110	150	265	150	474455	47,40



Novedad
New
nouveau

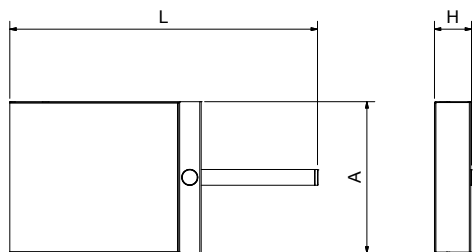

L	A	H	Gr	Barcode	€
390	192	47	600	084404	16,00

Recogedor de mano inox

Long handle stainless dustpan
Peel inoxydable avec manche

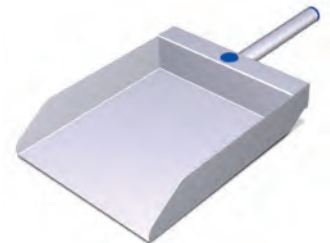

Novedad
New
nouveau

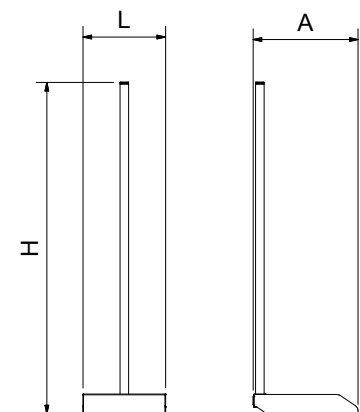

L	A	H	Kg	Barcode	€
244	192	770	1,0	084402	19,00

Recogedor inox

Stainless dustpan
Peel inoxydable



Novedad
New
nouveau

Recogedor con palo metálico

Dustpan with metal handle
Pelle avec manche métallique

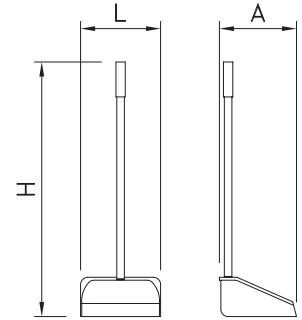

L	A	H	Gr	Barcode	€
275	265	875	250	482006	3,00

Recogedor abatible antiestático con mango una pieza

Antistatic dustpan with foldable handle, one piece
Pelle à ramasser rabattable antistatique avec manche une pièce



Novedad
ew
ouveau

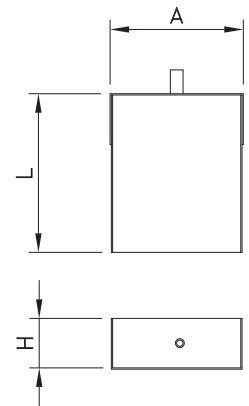

L	A	H	Kg	Barcode	€
330	310	125	1,15	482008	377,00

Cubo de plástico metal detectable

Plastic bucket, metal detectable
Seau en plastique, métal détectable

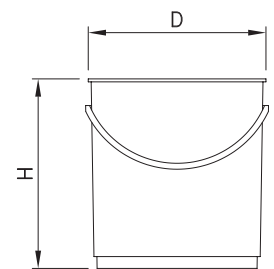

D	H	lit	Gr	Barcode	€
300	320	15 lts	1.150	465624	97,00

Cubo antiestático

Antistatic bucket
Seau antistatique



Novedad
ew
ouveau

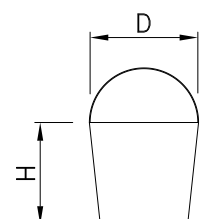

D	H	lit	Kg	Barcode	€
300	320	15 lt	1,15	465628	227,20

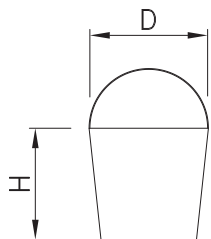

D	H	lit	Gr	Barcode	€
300	280	13	815	474462	18,00

Cubo industrial asa de acero inoxidable

Industrial bucket in stainless steel
Seau industriel en acier inoxydable

Características:

Material: HDPE.

Characteristics:

Material: HDPE.

Caractéristiques:

Matériel: HDPE.

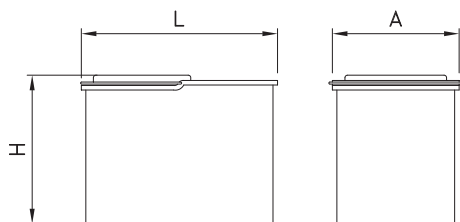

L	A	H	lit	Gr	Barcode	€
390	270	285	16	1.200	465626	12,00

Cubo plástico con asa metálica para fregar

Plastic cleaning bucket, metal handle
Seau de ménage avec poignée métallique

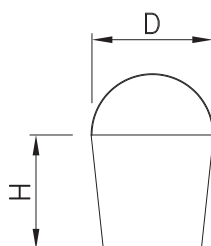

	H	D	lit	Gr	Barcode	€
	288	300	10 lts.	2.200	474492	66,00
	360	325	15 lts.	3.000	474496	77,00
		295	10 lts.	500	474494	19,00
		320	15 lts.	650	474498	22,00

Cubos de acero inox

Stainless steel bucket
Seaux en acier inoxydable

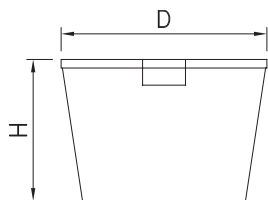
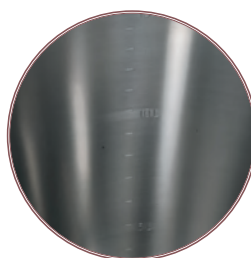

D	H	lit	Gr	Barcode	€
480	220	30	990	483050	20,20
	410	50	1.500	483054	27,40

Barreños

Food tubs
Baquets ronds aliments

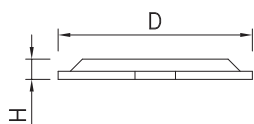

D	H	Gr	Barcode	€
490	50	560	483056	11,00

Tapa para barreños

Food tubs lid
Couvercle pour bassine



Urinaros inox

Inox urinals
Urinoir inox



Características:

Urinaros individuales y colectivos, para fijación mural, en acero inoxidable.
Entrada de agua superior de 3/8" conectada a tubo con reparto de descarga por toda la superficie del urinario.
Cubeta con desagüe central, diámetro de salida 1 y 1/2".
Incluye kit de fijación y un filtro aromatizante, color azul.

Characteristics:

Single and collective urinals, for wall mounting, stainless steel.
Upper water inlet 3/8" connected with discharge distribution across the surface of the urinal.
Tank fitted with central drain, outlet diameter 1 1/2"
Mounting kit and blue scented filter included.

Caractéristiques:

Urinoirs individuels et collectifs, pour montage mural, en acier inoxydable.
Entrée d'eau supérieure 3/8" relié au tube de distribution pour décharge en long de la surface de l'urinoir. Muni de drain, diamètre de sortie de 1 1/2"
Kit de montage et filtre bleu parfumée inclus.

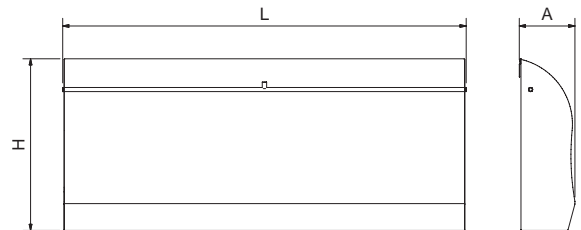
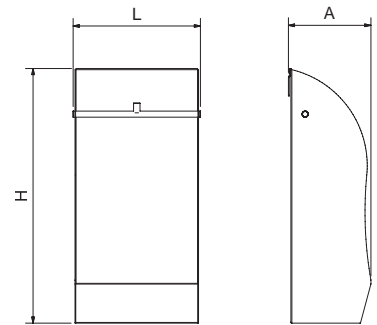

No incluye válvulas de agua.
Water valves not included.
Robinets d'eau non inclus.



Ver pág. 260.
See p. 260.
Voir p. 260.

L	A	H	Kg	Barcode	€
335	217	670	7,00	065002	385,00
1.575	217	670	22,00	065004	575,00

Filtro aromatizante para urinaros

Scented filter for urinals
Filtres parfumées pour urinoirs



Filtro específico para urinaros, con agentes neutralizantes y aromatizantes que reaccionan al contacto con la orina o el agua, desprendiendo una agradable fragancia. Su diseño evita atascos y su envasado es individual junto con un guante desechable para facilitar de una manera higiénica su mantenimiento.

Filter specifically for urinals, with neutralizing and scenting agents that react on contact with urine or water, emitting a pleasant fragrance.
Its design prevents clogging and is individually packaged with a disposable glove for ease of maintenance in a hygienic manner.

Filtre spécifiquement pour urinoirs, avec des agents neutralisants et odorisants qui réagissent au contact de l'urine ou l'eau et dégage un parfum agréable.
Sa conception évite le colmatage et est emballé individuellement avec un gant jetable pour faciliter la maintenance d'une manière hygiénique.

Barcode	€
465010	3,50

WC inox
Inox WC pan
Cuvette WC inox



456022 € (Op) 62,00

Tapa
Toilet lids
Toilette couvercle

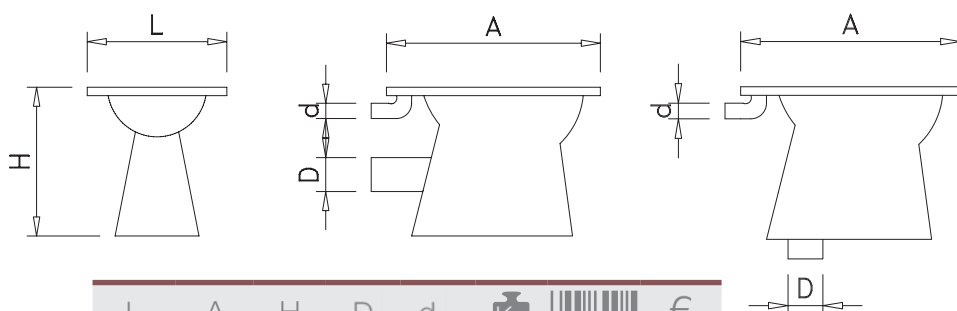

	L	A	H	D	d	Kg	Barcode	€
	366	521	390	3 1/2"	1 1/4"	7,89	456018	847,00
	366	521	390	3 1/2"	1 1/4"	7,89	456020	847,00

Taza turca inox
Inox squat toilet
Toilette turque inox

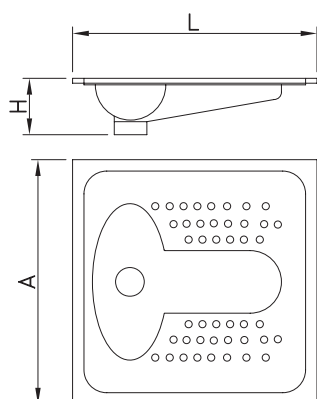

L	A	H	Kg	Barcode	€
750	750	133	6,27	456010	325,00

Set de cepillo y soporte inoxidable para baño
Brosse et support inoxydable pour bains
Brush and stainless support set for toilet

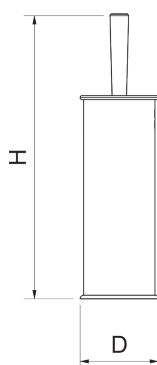

Incluye fijación a pared.
Includes wall fixing.
Comprend fixation murale.

H	D	Gr	Barcode	€
450	90	565	460240	37,00

Plato ducha inox

Inox shower tray
Plateaux douche inox



Novedad
ew
ouveau

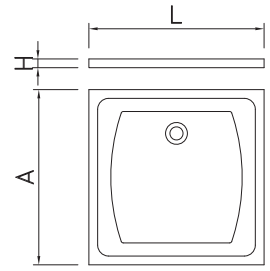

L	A	H	Kg	Barcode	€
750	750	40	5,50	456002	413,00
800	800	40	5,70	456004	458,00

Plato ducha lacado

Lacquer shower tray
Plateaux douche laqués



Novedad
ew
ouveau

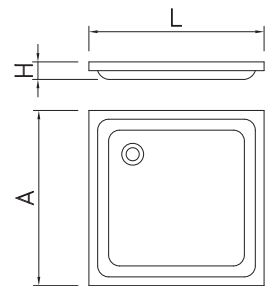

L	A	H	Kg	Barcode	€
600	700	70	4,61	456006	52,00
800	800	70	6,49	456008	70,00

Jabonera

Soap dish
Porte savon



L	A	H	Gr	Barcode	€
350	121	70	170	460270	41,00

Toallero

Towel bar
Barre porte serviette

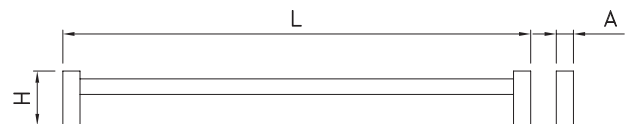

L	A	H	Gr	Barcode	€
600	70	22	150	460274	21,00

Portarrollos papel higiénico
Toilet paper roll dispenser
Distributeur papier hygiénique

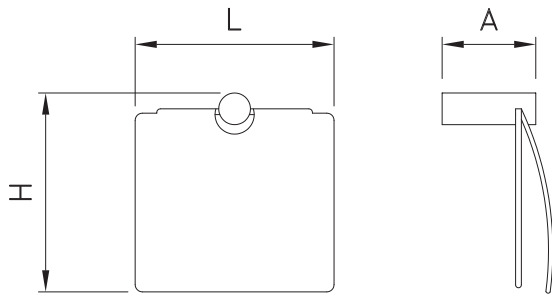

L	A	H	Gr	460272	€
122	55	115	160	460272	22,00

Perchero individual
Individual hanger
Patère individuel

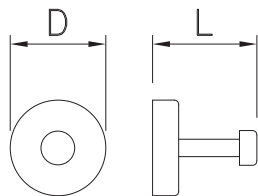

L	D	Gr	460276	€
60	55	80	460276	18,00

Repisa
Towel shelf
Tablette porte-serviettes

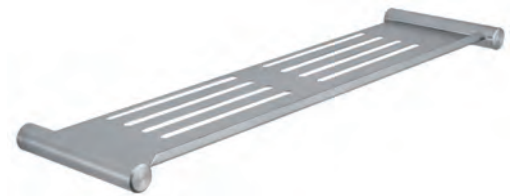
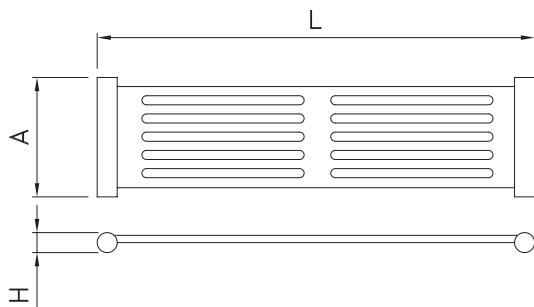

L	A	H	Gr	460278	€
480	131	22	210	460278	43,00

Tendedero retráctil
Retractable hanger
Fil à linge retractable

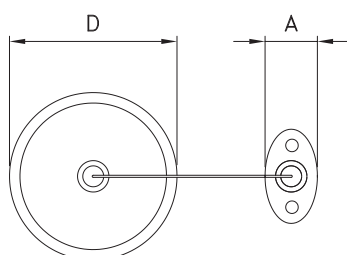

A	D	↔	Gr	481450	€
55	90	2,2 mts	140	481450	26,00

Espejo inox

Stainless steel mirror
Miroir inox



065004 575,00 392

Urinarios inox
Inox urinals
Urinoir inox



061440 795,00 191

Lavamanos mural colectivo
Wall-mounted collective washbasin
Lave-main mural collectif

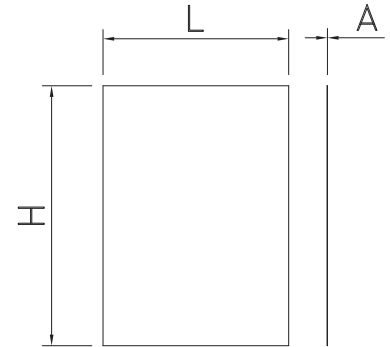

Características:

Completamente fabricado en acero inoxidable tipo 304 y con acabado pulido espejo.

Characteristics:

Wholly made in stainless steel polished mirror finish.

Caractéristiques:

Entièrement fabriqué en acier inoxydable poli, finition miroir.

L	A	H	Kg	Barcode	€
500	1	700	2,8	460252	132,00

Cambia pañales

Changing table
Table à langer



Características:

Fabricado 100% en polietileno de baja densidad microtexturizado con ausencia de puntos de fricción, superficie cóncava, correa de seguridad ajustable, cierre neumático. Superficie fácil de limpiar, dispensador de toallas de 30 uds. Y doble ganchos para bolsas.

Alta protección para los niños.

Hasta 100 kg de capacidad de carga.

Cumple con los códigos de acceso de discapacitados.

Characteristics:

Concave shaped easy-to-clean surface made 100% in low density microtextured polyethylene with no rubbing points. Provided with adjustable safety belt, pneumatic lock, dispenser for 30 towels and double bag hooks.

High safety for children.

Up to 100 kg load.

Complies with disabled access codes.

Caractéristiques:

Surface 100% en polyéthylène basse densité microtexturée sans points de friction. Pourvu avec ceinture de sécurité réglable, blocage pneumatique, distributeur de 30 serviettes et crochets double pour sacs.

Haute sécurité pour les enfants.

Jusqu'à 100 kg de charge.

Conforme aux codes d'accès handicapés.

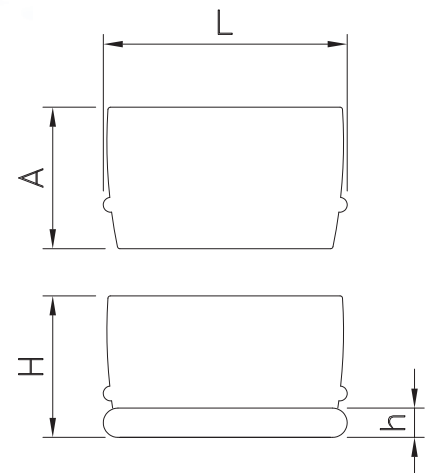

L	A	H	h	Kg	Barcode	€
872	510					
			102	8,90	460256	459,00
872	510	513				

Puesto de lavado y desinfección
Sanitary work station
Poste de lavage et de désinfection

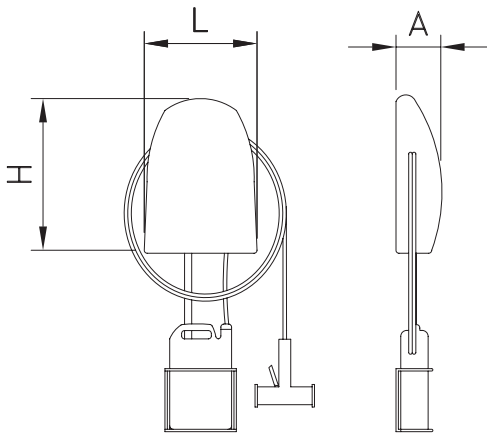

Características:
Soporte inox. para 1 garrafa de 5 litros.

Characteristics:
Inox holder for 5 litres tank

Caractéristiques:
Support inox pour réservoir de 5 litres



Longitud de manguera: 15 mts.
Hose length: 15 mts.
Longueur du tuyau: 15 mts.



L	A	H	Kg	Barcode	€
270	80	400	8,0	465602	553,00

Esterilizador automático de manos
Automatic hand sanitizer
Désinfecteur automatique de mains

Características:

Construcción en acero inoxidable.
Sensor infrarrojo de aplicación.
Visor para la comprobación del nivel y embudo para su relleno.
Fácil instalación.
Limpio, robusto y duradero.

La operación se realiza sin contacto evitando la contaminación cruzada de patógenos. Al colocar las manos debajo, expulsa una dosis de solución alcohólica evaporable.

Lugares de instalación: hospitales, clínicas, fábricas de productos alimenticios, comedores colectivos, aeropuertos, restaurantes, etc...



4 baterías AA de 1,5 V.
Capacidad 1 litro.
500 pulverizaciones.
Instalación mural.

Characteristics:

Wholly made of stainless steel.
Infrared sensor controlled.
Viewer for liquid level tracking and funnel for refilling.
Easy installation and maintenance.
Robust and lasting.

Touch-free operation to avoid pathogen cross-contamination: when placing your hands underneath, it ejects a dose of evaporable alcoholic solution.

Suitable for hospitals, food manufacturing plants, collective dining, airports, restaurants, etc...

4 batteries AA - 1,5 V.
Capacity of liquid container: 1.000 ml.
500 doses.
Wall-mounted.

Caractéristiques:

Entièrement en acier inoxydable.
Fonctionnement par senseur infrarouge.
Visueur pour vérifier le niveau de liquide et entonnoir pour le remplir.
Facilité d'installation et d'entretien.
Robuste et durable.

Désinfectez vos mains sans contact pour éviter la contamination croisée des agents pathogènes. Lorsque vous placez vos mains en dessous, il est éjecté une dose de solution évaporable alcoolique.

Convient pour les hôpitaux, les usines alimentaires, restauration collective, les aéroports, restaurants, etc...

4 piles AA - 1,5 V.
Capacité du réservoir de liquide: 1.000 ml.
500 doses.
Fixation murale.

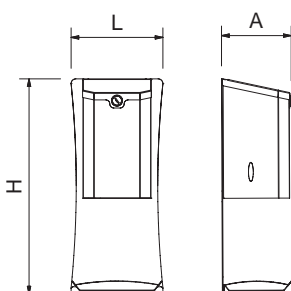

L	A	H	Kg	Barcode	€
192	145	450	2,6	064602	165,00

Dosificador de jabón

Soap dispenser
Doseur de savon

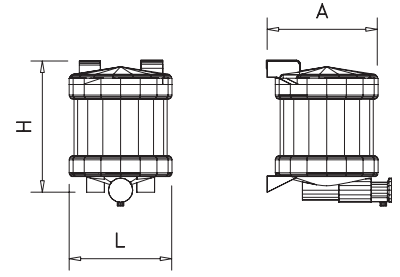

L	A	H	lit	Gr	Barcode	€
130	135	140	1 lts	400	460202	24,00

Dosificador de jabón

Soap dispenser
Doseur de savon



Características:

La tapa y el pulsador, por su diseño, no permite el apoyo de cigarrillos manteniendo un aspecto inmejorable. La estructura del vaso no permite que penetren impurezas en el conjunto pulsador, prolongando la vida del dispensador.

Characteristics:

The cover and the push-button, for their design, do not allow the support of cigarettes, maintaining an excellent aspect. The structure of the vase does not allow the penetration of impurities, prolonging the length of the dispenser.

Caractéristiques:

La couverture et le bouton-poussoir, par son desine, ne permettent pas l'appui des cigarettes et maintiennent un aspect excellent. La esturcture du vase ne permette pas que pénètrent impuretés dans le conjoint pousoir, prolongant ainsi la durée du dispensateur.

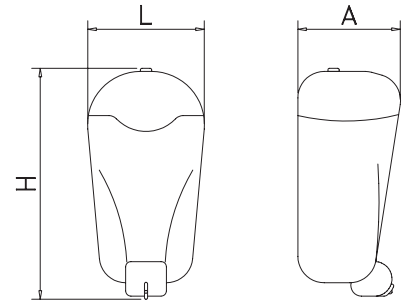

L	A	H	lit	Gr	Barcode	€
105	120	200	0,8 lts	375	460204	23,00

Dosificador de jabón modelo Nube

Soap dispenser, Cloud model
Distributeur de savon modèle Nuage

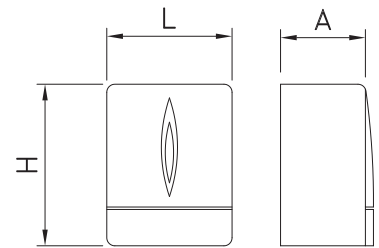

L	A	H	Gr	Barcode	€
155	115	201	544	460282	21,00

Dosificador de gel-espuma

Foam gel dispenser
Doseur pour gel à mousse

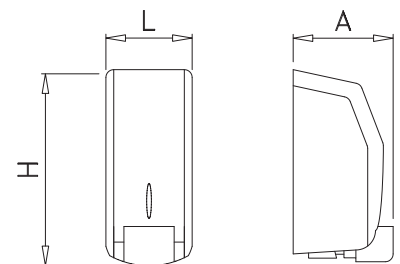

L	A	H	lit	Gr	Barcode	€
110	105	205	0,7 lts	500	460222	42,00

Jabonera electrónica (funcionamiento a pilas)

Hands-free soap dispenser (battery working)

Doseur de savon automatique (à piles)

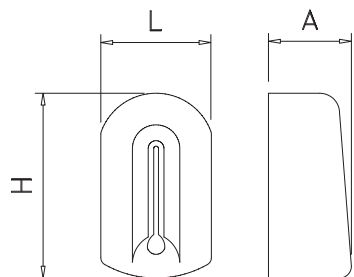

4 baterías AA de 1,5 V.

4 batteries AA - 1,5 V.

4 piles AA - 1,5 V.

L	A	H	lit	Gr	Barcode	€
140	105	235	1 lts	525	460236	38,00



Dosificador de jabón inox

Stainless steel soap dispenser

Doseur de savon en acier inoxydable

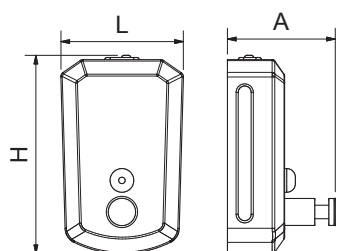

L	A	H	lit	Gr	Barcode	€
115	100	178	0,8 lts	700	460219	33,00
130	105	203	1,2 lts	900	460220	38,00



Dosificador de jabón inox encastrable

Stainless steel soap dispenser to be embedded

Doseur de savon en acier inoxydable pour adosser

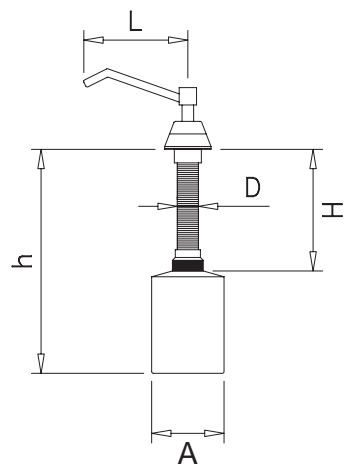

L	A	H	h	D	lit	Gr	Barcode	€
105	75	132	240	22	500 ml	580	460218	70,00



Secamanos inox con pulsador y tobera

Stainless push-button operated hand dryer with nozzle

Sèche-mains inox avec poussoir et tuyère

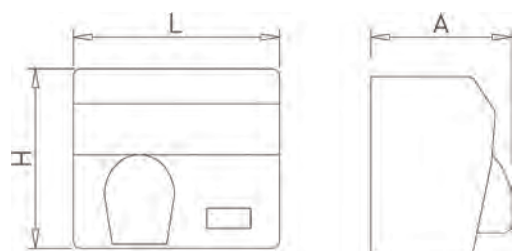

L	A	H	r.p.m.	Tensión Voltage Tension	Frecuencia Frequency Frecuence	Potencia Power Puissance	Kg	Barcode	€
265	210	240	7.500	230 V	50 Hz	2500 W	6,30	460290	238,00



Novedad
ew
ouveau

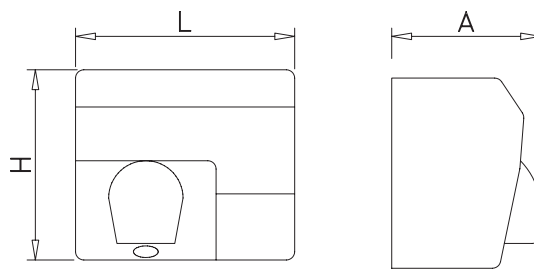

Secamanos óptico inox satinado con tobera

Stainless satiny optic hand drier with nozzle
Sèche-mains optique inoxydable satiné avec tuyère





L	A	H	 r.p.m.	Tensión Voltage Tension	Frecuencia Frequency Frecuence	Potencia Power Puissance	 Kg		€
270	200	240	7.500	230 V	50 Hz	2500 W	6,00	460228	228,00

Secamanos óptico inox satinado sin tobera

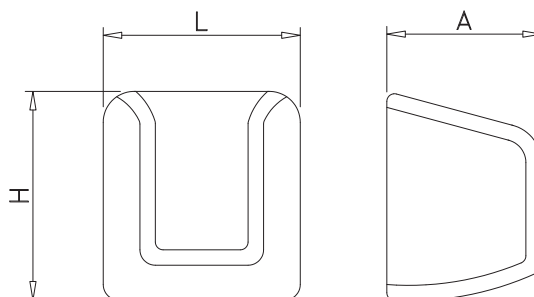
Stainless satiny optic hand drier without nozzle
Sèche-mains optique inoxydable satiné sans tuyère





L	A	H	 r.p.m.	Tensión Voltage Tension	Frecuencia Frequency Frecuence	Potencia Power Puissance	 Kg		€
260	180	260	7.500	230 V	50 Hz	2.100 W	3,16	460226	180,00

Secamanos óptico en ABS

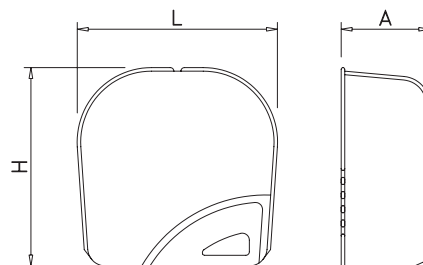
ABS optic hand drier
Sèche mains optique ABS





L	A	H	 r.p.m.	Tensión Voltage Tension	Frecuencia Frequency Frecuence	Potencia Power Puissance	 Kg		€
275	127	250	6.000	230 V	50 Hz	1.750 W	2,7	460206	130,00

Secamanos óptico en ABS sin tobera modelo Nube

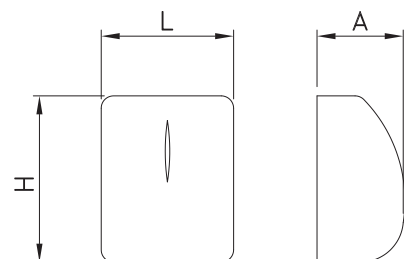
ABS automatic hand dryer without nozzle, Cloud model
Sèche-mains optique ABS sans tuyère modèle Nuage



L	A	H	Tensión Voltage Tension	Frecuencia Frequency Frecuence	Potencia Power Puissance	 Kg		€
215	140	270	230 V	50 Hz	1.800 W	1,3	460286	151,00

Secamanos inox de bajo consumo

Stainless steel low consumption hand drier
Sèche mains inox consommation bas

Características:

Seca las manos mediante aire comprimido a alta velocidad.

Sin resistencia eléctrica, consigue calentar el aire mediante el aprovechamiento de la potencia del motor, reduciendo al máximo el consumo eléctrico.

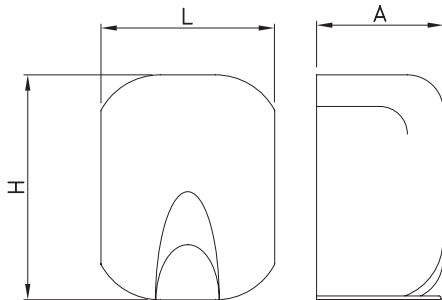

Characteristics:

Dries hands with a high flow of compressed air.

Without electrical resistance, the air gets heated by using the power of the engine, minimizing the electricity consumption.

Caractéristiques:

Séchage de mains avec air comprimé à fort débit.

Sans résistance électrique, l'air est chauffé à l'aide de la puissance du moteur, réduisant la consommation d'électricité.



L	A	H	rp.m.	Tensión Voltage Tension	Frecuencia Frequency Frequence	Potencia Power Puissance	Kg	Barcode	€
221	157	285	26.000	220/240 V	50/60 Hz	550 W	3,0	460250	400,00

Secamanos óptico ultrarápido Jet-01

Ultra-fast optic hand drier Jet-01
Seche mains optique ultra-rapide Jet-01

Características:

Secado ultra rápido.
Carcasa de aluminio antivandálico color epoxi gris.
Detector de proximidad.
Efecto luminoso.
Cierre con llave.

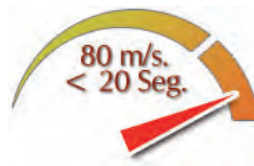
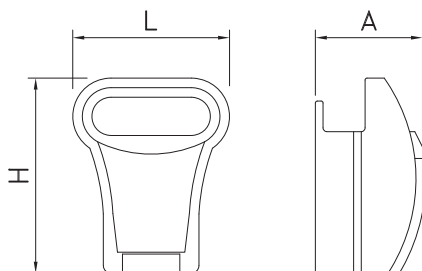

Characteristics:

Ultra-fast drying.
Vandal-proof aluminium casing, grey epoxy color.
Proximity switch.
Lighting effect.
Key locking.



Caractéristiques:

Séchage ultra-rapide.
Boîtier en aluminium anti-vandalisme, couleur gris époxy.
Détecteur de proximité.
Effet lumineux.
Fermeture avec clef.

L	A	H	rp.m.	Tensión Voltage Tension	Frecuencia Frequency Frequence	Potencia Power Puissance	Kg	Barcode	€
343	232	430	30.000	230 V	50 Hz	1.750 W	7,0	460251	690,00

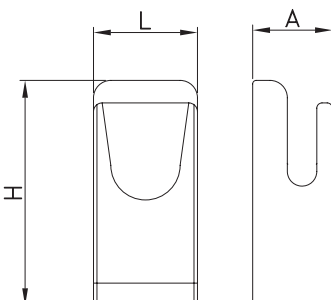
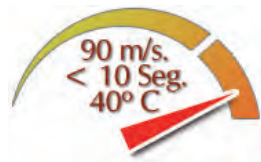

Características:

Nuevo concepto de diseño ergonómico para el secado de manos.
Menor consumo energético al no lleva resistencia para calentar el aire, ahorra hasta un 80 % los costes de secado frente a sistemas de papel especial o algodón.
Secado perfecto ultrarrápido gracias a su doble flujo de aire comprimido. Construido en ABS.

Characteristics:

New conception of ergonomic design for hand driers.
It does not need a resistance for heating air, which means an 80% of drying consumption reduction in comparison with paper or cotton systems.
Ultra-fast and thorough drying, thanks to its double flow of compressed air. Made of ABS.

L	A	H	rp.m.	Tensión Voltage Tension	Frecuencia Frequency Frequence	Potencia Power Puissance	Kg	Barcode	€
300	220	685	30.000	230 V	50 Hz	1.650 W	12,0	460238	700,00

Secamanos ultrarápido

Ultra-fast hand drier
Sèche-main ultra-rapide



Caractéristiques:

Nouvelle conception ergonomique pour sèche à mains.
Il n'a pas besoin d'une résistance pour chauffer l'air, ce pour cela qu'il économise un 80% la consommation de séchage par rapport aux systèmes papier ou de coton.
Séchage complet ultra-rapide grâce à son double flux d'air comprimé. Fabriqué en ABS.

Dispensador de rollos de papel higiénico

Dispenser for rolls of toilet paper
Dévidoirs de rouleaux de papier hygiénique

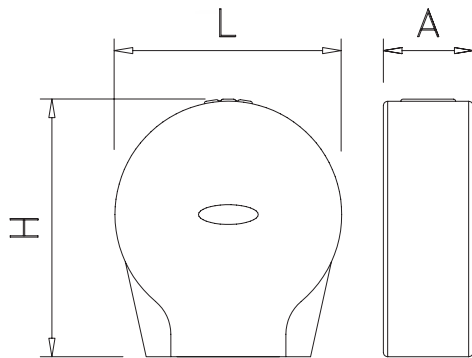

Características:

Pensado para los tipos de bobina más usuales del mercado.
Dispone de cierre de seguridad que reduce el mal uso del producto.

Tipo de rollo: Bobina de 250/300 m
Ejes: Ø de 25, 45 y 60 mm

Characteristics:

Thought for the more usual kind of rolls in the market.
Provided with a security shut that reduces the wrong usage of the product.

Type of roll: 250/300 m
Axes: Ø 25, 45 y 60 mm

Caractéristiques:

Conçu pour les types de rouleaux les plus usuels du marché.
Il a une fermeture de sécurité qui réduit le mal usage du produit.

Type de rouleau: 250/300 m
Axes: Ø 25, 45 y 60 mm

L	A	H	Gr	Barcode	€
265	132	284	700	460210	20,00

Dispensador de rollos de papel higiénico inoxidable

Stainless steel dispenser for rolls of toilet paper
Dévidoirs de rouleaux de papier hygiénique en acier inoxydable

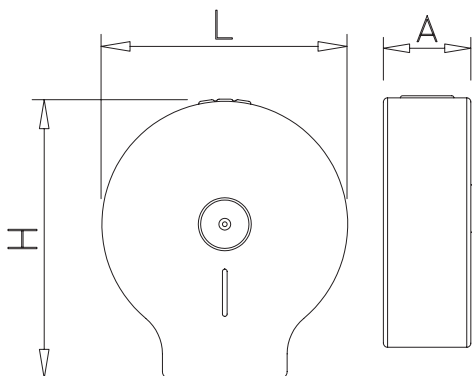

Características:

Pensado para los tipos de bobina más usuales del mercado.
El cierre de seguridad reduce el mal uso del producto y ofrece sencillez en la reposición del papel.

Tipo de rollo: Bobina de 250/300 m
Ejes: Ø de 40 mm

Characteristics:

Thought for the more usual kind of rolls in the market.
The security lock reduces the wrong usage of the product and offers easiness when replacing the toilet paper.

Type of roll: 250/300 m
Axes: Ø 40 mm

Caractéristiques:

Conçu pour les types de rouleaux les plus usuels du marché.
Le fermeture de sécurité réduit le mal usage de ce produit et offre facilité pour la reposition du papier.

Type de rouleau: 250/300 m
Axes: Ø 40 mm

L	A	H	Kg	Barcode	€
250	120	260	1,6	460212	36,00

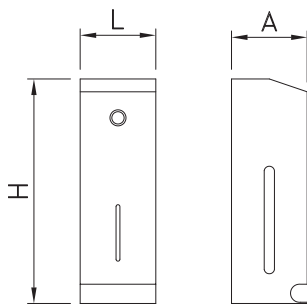

Dispensador de papel higiénico triple

Triple dispenser for toilet paper
Dévidoir de papier hygiénique triple



L	A	H	Kg	460254	€
118	110	370	2,50	460254	65,00

Dispensador de toallas

Towels dispenser
Dispensateur d'essuie-mains

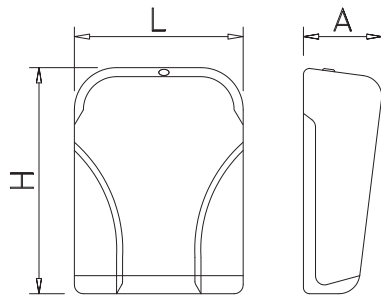

Características:

El innovador diseño del conjunto llave-cerradura ofrece seguridad al producto, evitando un mal uso del papel. Sus formas redondeadas de mayor resistencia al impacto permiten ofrecer un producto robusto y capaz de adaptarse a cualquier entorno.

Characteristics:

The innovating design of the set key-lock offers security to this product and avoids a wrong usage of the paper. Its rounded shapes of a higher impact resistance let offer a strong product capable to be adapted at any place.

Caractéristiques:

L'innovateur dessin du conjoint clé-fermeture, offre sécurité au produit, en évitant le mal usage du papier. Ses formes arrondis d'une plus grande résistance au impacte permettent offrir un produit robuste et capacité pour s'adapter a quelque endroit.

L	A	H	600 servicios	Kg	460214	€
275	130	370	Use for 600 applications 600 applications d'usage	1,1	460214	23,00

Dispensador en acero inoxidable de toallas de papel

Stainless steel towel dispenser
Dispensateur en acier inoxydable d'essuie-mains

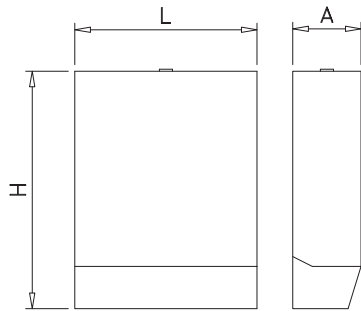

L	A	H	400/600 servicios	Kg	460224	€
280	105	365	Use for 400/600 applications 400/600 applications d'usage	2,45	460224	42,00

Dispensador de bolsitas higiénicas

Higienic bags dispenser
Distributeur de sacs hygiéniques

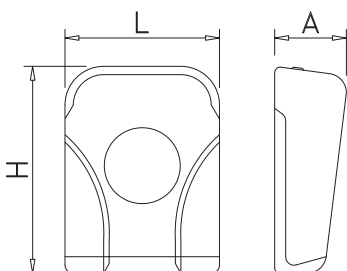

L	A	H	Gr	460258	€
120	40	155	130	460258	12,00

Dispensador automático de toallas

Automatic towel dispenser
Distributeur automatique de serviettes



Novedad
ew
ouveau

Características:

Cerradura con llave para prevenir el robo.
Adecuado para la mayoría de rollos no perforados de toallas hasta 20,32 cm de ancho y 20,32 cm de diámetro al utilizar centros de diámetro interno de 3,81cm.
Suministra hojas de 279,4 mm.
Bandeja para rollo residual o reserva incluida.
Funcionamiento suave y confiable.
Plástico de alto impacto en frente y parte posterior.

Characteristics:

Key and lock for paper roll protection.
Intended for most of the non-perforated towel rolls.
Provides towels up to 279,4 mm.
Tray for spare roll included.
Smooth and reliable functioning.
Front and rear high-impact resistance plastic.

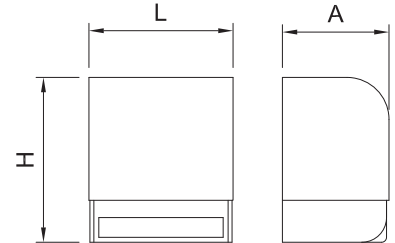

Caractéristiques:

Serrure avec clef pour protéger le rouleau.
Approprié pour la majorité de rouleaux non perforés de serviettes jusqu'à 20,32 cm de largeur et 20,32 cm de diamètre, en usant des centres de diamètre interne de 3,81 cm.
Fournit des feuilles de 279,4 mm
Plateau pour rouleau résiduel ou de réserve, inclus.
Fonctionnement fiable.
Plastique de grand impact frontal et postérieur.

L	A	H	Tensión Voltage Tension	Frecuencia Frequency Frecuence	Potencia Power Puissance	Kg	Barcode	€
292	216	335	240 V	50 Hz	300 W	1,8	460266	128,00

Dispensador de papel mini-mecha modelo Nube

Centre feed mini towel dispenser, Cloud model
Distributeur de papier cheminé modèle Nuage

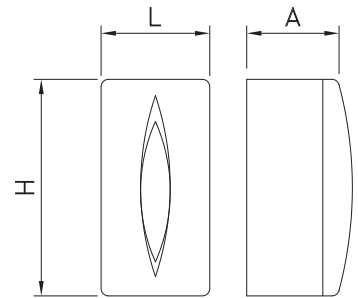

L	A	H	Gr	Barcode	€
147	143	293	170	460280	19,80

Dispensador de papel higiénico modelo Nube

Toilet paper dispenser, Cloud model
Distributeur de papier toilette modèle Nuage

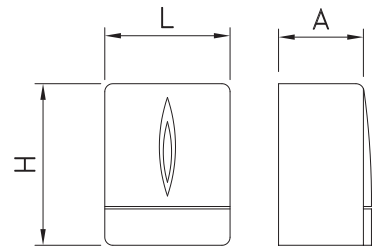
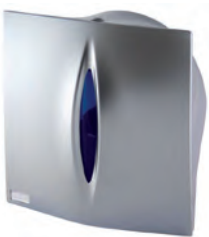

L	A	H	Gr	Barcode	€
276	143	275	765	460284	23,00

Dispensador de toallas modelo Nube

Towel dispenser, Cloud model
Distributeur de papier essuie-mains modèle Nuage

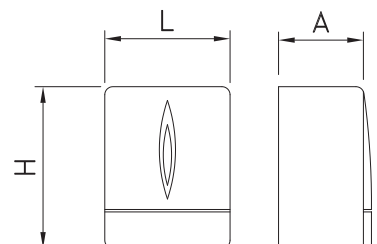

L	A	H	Gr	Barcode	€
308	149	331	1.057	460288	24,00

Dispensador de papel mecha
Wick-paper dispenser
Dispensateur de papier-mèche

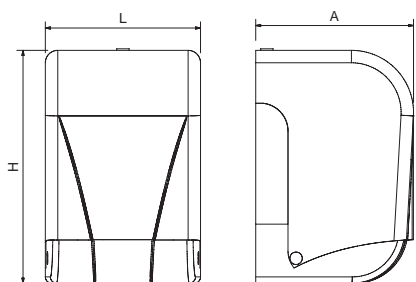

L	A	H	Gr	Barcode	€
260	260	370	800	460216	33,00

Características:
Dispensador de papel mecha muy funcional por su tamaño y sencillez. Para todo tipo de papel mecha con o sin precorte.

Characteristics:
Very useful wick-paper dispenser because of its size and simplicity. For all kinds of wick-paper, with or without cut.

Caractéristiques:
Dispensateur de papier-mèche très fonctionel par ses dimensions et simplicité. Pour tous les types de papier-mèche, sans et avec coupure.



Dispensador de papel mecha en acero inox
Stainless steel wick-paper dispenser
Dispensateur de papier-mèche en acier inoxydable

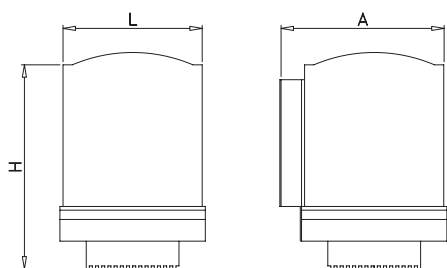

L	A	H	Kg	Barcode	€
250	270	320	3,3	460208	133,00



Dispensador de bobina industrial
Industrial roll dispenser
Distributeur de bobine industrielle

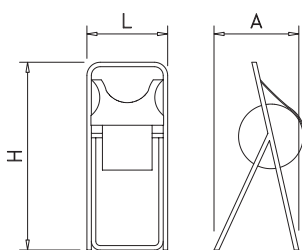

L	A	H	Gr	Barcode	€
400	420	930	270	460262	33,00



Dispensador mural de bobina industrial
Industrial roll wall-dispenser
Distributeur mural de bobine industrielle

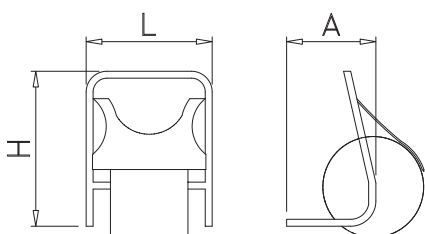

L	A	H	Gr	Barcode	€
390	240	460	100	460264	25,00



Dispensador y cepillos para limpieza de manos y uñas

Brushes and dispenser for hands and nails washing
Dispensateur et brosse pour le lavage des mains et ongles



Características:

Los cepillos son desechables y ayudan a prevenir contagios en el lavamanos. El diseño único del cepillo elimina la suciedad y las bacterias de poros, arrugas, uñas y cutículas. Tan sólo utilícelo un día y deséchelo.

Color azul para fácil identificación y seguridad alimentaria.
Canal central para limpieza bajo las uñas.

El dispensador puede colocarse atornillado a la pared o de sobremesa.

Characteristics:

The brushes are disposable and help prevent cross-contamination at the hand washing sink. The unique design of the brush effectively removes soil and bacteria from pores, wrinkles, nails and cuticles. Simply use for a day and then throw it away.

Food safe blue colour for easy identification.
Centre channel for cleaning under nails.
Wall dispenser can be placed over sink for easy access.

Caractéristiques:

Les brosses sont jetables et aident à prévenir des contagés dans le lave-main. Le dessin unique du brosse élimine la saleté et les bactéries des pores, rides, ongles et cuticules. Uniquement utilisez-le un jour et jetez-le.

Couleur bleu pour son facile identification et sécurité alimentaire.
Channel central pour nettoyer dessus les ongles.
Le dispensateur peut s'installer visé au mur ou sur table.

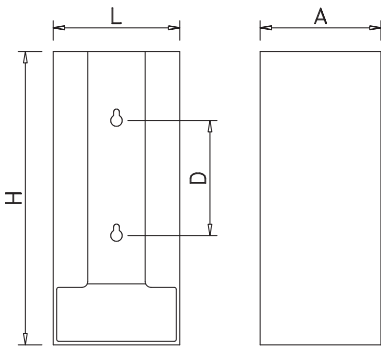

Dispensador Dispenser Dispensateur	L	A	H	D	Gr	€
	110	105	255	100	270	46,00

					Uds. Units Unités	
Caja con limpiaúñas Nail wiper box Boite avec nettoyeur d'ongles	Gr				€	
	0,5	36	460232	48,00		

Dispensador inox para cepillos de limpieza de manos y uñas

Stainless steel dispenser for hands and nails washing-brusher
Dispensateur inoxydable de brosses à mains et ongles

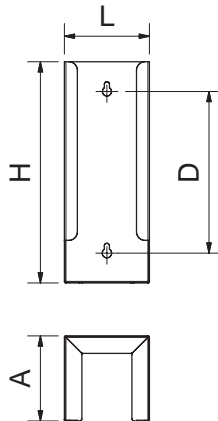

L	A	H	D	Gr	€
100	100	260	190	600	15,00

Cepillo limpiaúñas de uso personal

Nail brush for personal use
Brosse à ongles pour usage personnel



Características:

Elimina la suciedad y las bacterias de poros, arrugas, uñas y cutículas.

Characteristics:

Remove dirtiness and bacteria from pores, wrinkles, nails and cuticles.

Caractéristiques:

Éliminer saleté et bactéries des pores, rides, ongles et cuticules.

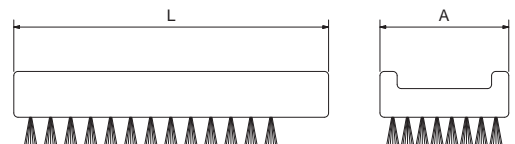

L	A	Gr	€
110	45	70	9,50

Hacha de cámara con mango de fibra
Chamber axe with polyethylene fibre
Hache de chambre avec manche en fibre



Aplicación:

Especial para el cumplimiento del reglamento de Industria ("Reglamento de Seguridad para Plantas e Instalaciones Frigoríficas", RD 3099/77) para cámaras frigoríficas de gran superficie cuya temperatura de trabajo sea inferior a 0 grados.

Se recomienda su instalación, como buena práctica, en otros casos (restaurantes, comercios, etc.) donde se pueden encontrar cámaras no afectadas por el reglamento de Industria, pero que son de congelación y en las que los trabajadores puedan trabajar en el interior de las mismas con la puerta cerrada.

Use:

Special for the compliance of the EU regulations on cold rooms of wide area which can work with temperatures below zero.

It is recommended to install it as a good use in other cases (restaurants, butcher shops, fish shops, etc.) where you can find cold rooms not affected by with this regulation, but that are also cold rooms where workers can work inside them with the door closed.

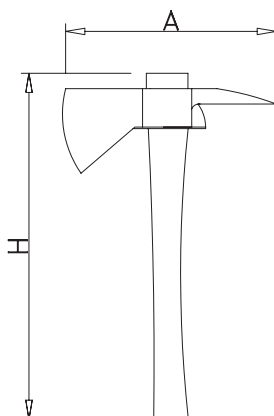

H	A	Gr	Barcode	€
450	270	1.200	449202	125,00

Applications:

Spéciale pour l'accomplissement de le règlement du UE pour chambres frigorífiques à grande superficie dont température de fonctionnement soit au-dessous de zéro.

On recommande son installation comme bonne coutume dans autres cases (restaurants, boucheries, poissonneries, etc.) ou on peut trouver chambres qui ne sont pas touchées par ce règlement, mais qui sont aussi à congélation et les travailleurs peuvent travailler dans s'intérieur avec la porte fermée.

Hacha de bombero con mango de fibra
Firefighter axe with polyethylene fibre
Hache de pompier avec manche en fibre



Aplicación:

Especial para el cumplimiento del reglamento de Industria ("Reglamento de Seguridad para Plantas e Instalaciones Frigoríficas", RD 3099/77) para cámaras frigoríficas de gran superficie cuya temperatura de trabajo sea inferior a 0 grados.

Se recomienda su instalación, como buena práctica, en otros casos (restaurantes, comercios, etc.) donde se pueden encontrar cámaras no afectadas por el reglamento de Industria, pero que son de congelación y en las que los trabajadores puedan trabajar en el interior de las mismas con la puerta cerrada.

Use:

Special for the compliance of the EU regulations on cold rooms of wide area which can work with temperatures below zero.

It is recommended to install it as a good use in other cases (restaurants, butcher shops, fish shops, etc.) where you can find cold rooms not affected by with this regulation, but that are also cold rooms where workers can work inside them with the door closed.

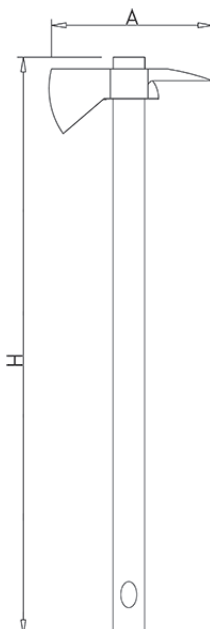

H	A	Gr	Barcode	€
910	290	1.900	042004	91,00

Applications:

Spéciale pour l'accomplissement de le règlement du UE pour chambres frigorífiques à grande superficie dont température de fonctionnement soit au-dessous de zéro.

On recommande son installation comme bonne coutume dans autres cases (restaurants, boucheries, poissonneries, etc.) ou on peut trouver chambres qui ne sont pas touchées par ce règlement, mais qui sont aussi à congélation et les travailleurs peuvent travailler dans s'intérieur avec la porte fermée.



COMPLEMENTOS

Complements
Complements

NOVEDADES

News
Nouveautés

Lavaporcionador de helados para encastrar Built-in ice-cream scoop washer Rince bouliers à glace pour encastrer.....	410	Dispensador de vasos universal Universal cup dispenser Distributeur universel de gobelets	432
Lavaporcionador de helados mural Wall-mounted ice-cream scoop washer Rince bouliers à glace mural	411	Cepillo lavavasos Glass washer brush Brosse pour lave-verres.....	434
Porcionadores de helado Stainless steel and nylon ice cream scoop Boulier à glace.....	411	Vitrina expositora Counter-top store display showcase Vitrine d'exposition	438
Cubetas GN para identificación de alérgenos Gastronorm containers for allergen marking Bac en polypropylène antiallergique.....	417	Gaveta expositora Pick and mix bin Casier de rangement	438
Tapa para cubetas GN para identificación de alérgenos Lid for Gastronorm containers for allergen marking Couvercle pour Cuvettes GN pour identification d'allergènes	417	Portaprecios en varilla inox con pincho Inox price-holder rod with spike Porte-prix en tige inox avec broche.....	440
Tapas de polipropileno GN de colores Perforated bottoms for Gastronorm containers high temperatures Couvercles en polypropylène GN plusieurs couleurs.....	419	Portaprecios en varilla inox Inox price-holder rod Porte-prix en tige inox.....	440
Bandejas de presentación BP1 Presentation tray BP1 Plateau de présentation BP1.....	422	Envasadora al vacío Vacuum packaging machine Machine d'emballage sous vide.....	442
Bandejas de presentación BP2 Presentation tray BP2 Plateau de présentation BP2.....	423	Columna señalización con cinta Belt barrier post Colonne de signalisation avec bande	448
Bandeja Gastronorm de presentación BP3 Gastronorm presentation tray BP3 Plateau Gastronorm de présentation BP3.....	423	Plataforma con freno para transporte de cestos de lavavajillas Cart for racks with break Plate-forme pour transport de paniers de lave-vaisselle.....	454
Bandeja de camarero especial jarras de cerveza Trays for beer Plateau garçon de café spécial pour pichet de bière.....	424	Buzón inoxidable Mailbox stainless steel Boîte aux lettres inoxydable.....	455
Caja alimentaria apilable Stackable box for food use Boîte alimentaire empilable	428	Buzón inoxidable Plus Mailbox stainless steel Plus Der rostfreie Plus Briefkasten.....	455
Tapa para caja alimentaria apilable Lid for stackable food box Couvercle pour boîte alimentaire empilable.....	428	Pincho antipalomas en acero inoxidable Stainless steel deterrent spikes for pigeons Tige anti-pigeons en acier inoxydable.....	455
Tapa para cubrir cestos de lavavajillas Lid cover for racks Couvercle pour boîte alimentaire empilable.....	430	Cenicero melamina "Lucky" Melamine ashtray "Lucky" Cendrier en mélamine "Lucky"	461
Cestos de vasos para lavavajillas Dishwasher rack for glasses Paniers pour verres pour lave-vaisselle...	430	Kit golpeador para cajón pequeño Coffee grounds striker kit for small drawer Barre pour petit tiroir de marc à café	465
		Adaptador enchufe tipo H Type H plug adapter Adaptateur pour prise électrique type H..	468



Cubetas para helado

Ice cream container
Bac à crème glacée



Características:

Cubetas conforme a la norma EN 631, utilizadas para el sector del helado.

Characteristics:

Set of containers normalized according to the norm EN 631, used for ice cream.

Caractéristiques:

Série de bacs normalisés selon la norme EN 631, utilisées pour glacée.

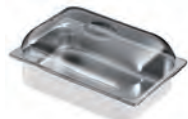
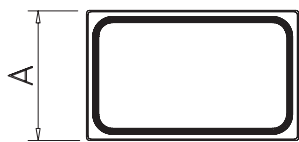
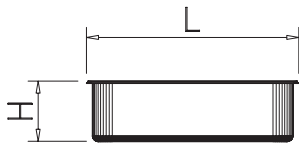

L	A	H	lit	Gr	Barcode	€
180	165	120	2,50	325	487400	22,00
330	165	120	5,35	610	487402	20,00
360	165	120	5,91	635	487404	15,00
330	250	80	5,50	600	487405	20,00
360	250	80	5,97	745	487406	14,00
265	160	80	3,60	310	487410	11,00
330	165	80	3,90	400	487412	13,00
360	165	80	3,80	430	487414	12,00
265	160	120	3,00	450	487416	14,00
330	250	120	7,00	890	487418	32,00

ø200	250	15,70	520	487408	47,00
------	-----	-------	-----	--------	-------

330	165	20		120	487450	4,50
-----	-----	----	--	-----	--------	------

360	165	20		135	487452	4,60
-----	-----	----	--	-----	--------	------

360	250	80		180	487454	5,00
-----	-----	----	--	-----	--------	------

260		∅		487480	4,50
-----	--	---	--	--------	------

300		50 mm.		487482	4,50
-----	--	--------	--	--------	------

Lavaporcionador de helados para encastrar

Built-in ice-cream scoop washer
Rince bouliers à glace pour encastrar



Características:

Entrada de agua con válvula de 3/8"
Desagüe con válvula de 1/2"

Characteristics:

Inlet valve 3/8"
Outlet valve 1/2"

Caractéristiques:

Entrée d'eau avec bonde de 3/8"
Bonde d'évacuation de 1/2"

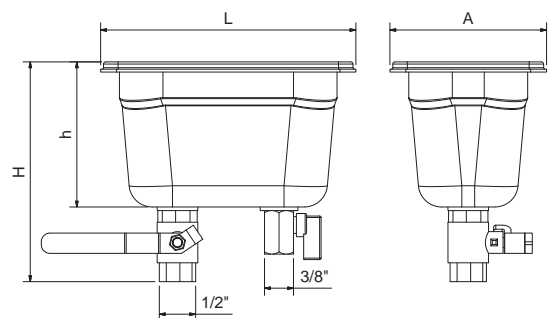

L	A	H	h	Gr	Barcode	€
176	108	151	100	500	082830	73,00

Lavaporcionador de helados mural

Wall-mounted ice-cream scoop washer
Rince bouliers à glace mural

Características:

Entrada de agua con válvula de 3/8"
Desagüe con válvula de 1/2"

Characteristics:

Inlet valve 3/8"
Outlet valve 1/2"

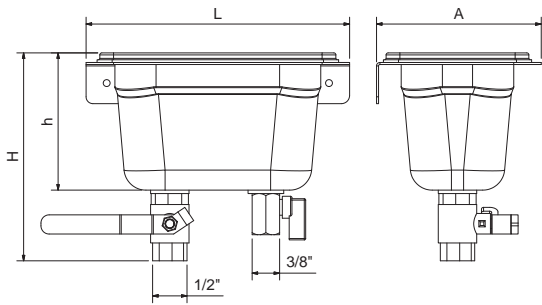

Novedad
ew
ouveau

Caractéristiques:

Entrée d'eau avec bonde de 3/8"
Bonde d'évacuation de 1/2"

L	A	H	h	Gr	Barcode	€
192	120	151	100	700	082832	90,00

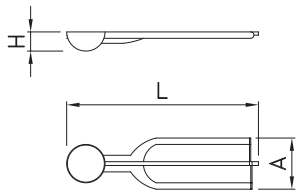

L	A	H	Color	Gr	Barcode	€
190	65	33		200	487470	28,00
				200	487472	
				200	487474	
				200	487476	



Ver pag. 414
See page 414
Voir page 414

Novedad
ew
ouveau

∅
50
mm.



Porcionadores de helado

Stainless steel and nylon ice cream scoop
Boulier à glace

Porcionador automático de helado

Spring action ice-cream scoop
Cuillère à crème glacée avec lame intérieur

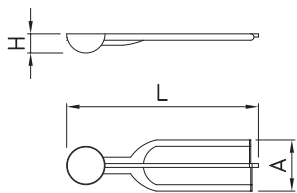

L	A	H	Gr	Barcode	€
190	65	33	220	440016	11,00



∅
50
mm.

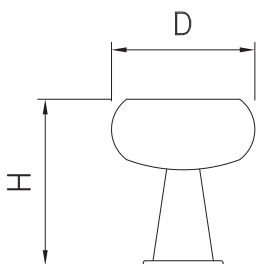

H	D	Gr	Barcode	€
110	85	150	487490	20,00
110	95	180	487492	24,00
110	105	200	487494	26,00



Copa helado

Ice cream bowl
Bowl pour crème glacée



Cubetas Gastronorm lisas

Non-perforated Gastronorm containers
Bacs Gastronorm lisses



Características:

Cubetas conforme a la norma EN 631, utilizadas para la preparación, cocción, congelación, descongelación y distribución de alimentos.

Fabricadas en acero inoxidable.

Posibilidad de encargar bajo pedido: Cubetas con asas, tapaderas con orificio para cuchara y tapaderas con junta hermética.

Characteristics:

Set of containers normalized according to the norm EN 631, used for the preparation, cooking, freezing, defrosting and distribution of foodstuffs.

Made in stainless steel.

Possibility of make to order: container with handles, kitchen spoon lids, lids with hermetic joints.

Caractéristiques:

Série de bacs normalisés selon la norme EN 631, utilisées pour la préparation, cuisson, surgélation, décongélation et distribution des aliments.

Fabriquées en acier inoxydable.

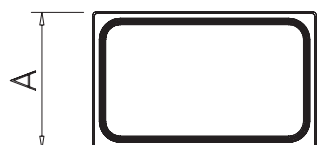
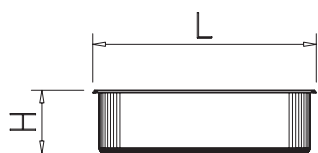

Possibilité de demander sur commande: bac avec poignées, couvercles avec découpage pour louche, couvercles avec joint hermétique.



Modelo Model Model	L	A	H				€
2/1 - 20	650	530	20	5,70	2.726	486802	39,89
2/1 - 40	650	530	40	10,50	2.957	486804	41,93
2/1 - 65	650	530	65	18,50	3.255	486806	48,91
2/1 - 100	650	530	100	28,00	3.650	486808	57,77
2/1 - 150	650	530	150	42,00	4.230	486810	83,62
2/1 - 200	650	530	200	56,50	4.800	486812	94,10
1/1 - 20	530	325	20	2,75	1.100	486814	17,90
1/1 - 40	530	325	40	5,50	1.269	486816	20,78
1/1 - 65	530	325	65	9,50	1.365	486818	23,00
1/1 - 100	530	325	100	14,00	1.652	486820	30,39
1/1 - 150	530	325	150	21,00	1.965	486822	44,02
1/1 - 200	530	325	200	28,00	2.292	486824	51,34
2/3 - 20	354	325	20	1,85	708	486826	13,56
2/3 - 40	354	325	40	3,20	803	486828	15,08
2/3 - 65	354	325	65	5,50	830	486830	17,10
2/3 - 100	354	325	100	8,70	1.116	486832	22,11
2/3 - 150	354	325	150	13,00	1.380	486834	36,36
2/3 - 200	354	325	200	18,00	1.639	486836	42,39
1/2 - 20	325	265	20	1,38	475	486838	10,18
1/2 - 40	325	265	40	2,20	573	486840	12,25
1/2 - 65	325	265	65	3,70	663	486842	14,03
1/2 - 100	325	265	100	6,50	818	486844	17,13
1/2 - 150	325	265	150	9,50	944	486846	26,85
1/2 - 200	325	265	200	12,50	1.350	486848	33,60
2/4 - 20	530	162	20	1,37	550	486890	13,18
2/4 - 40	530	162	40	2,75	634	486892	15,92
2/4 - 65	530	162	65	4,75	682	486894	18,51
2/4 - 100	530	162	100	7,00	826	486896	28,07
2/4 - 150	530	162	150	10,50	982	486898	36,55
1/3 - 20	325	176	20	0,90	317	486850	9,29
1/3 - 40	325	176	40	1,50	380	486852	10,75
1/3 - 65	325	176	65	2,50	488	486854	12,27
1/3 - 100	325	176	100	3,70	581	486856	14,63
1/3 - 150	325	176	150	5,70	698	486858	21,36
1/3 - 200	325	176	200	7,70	770	486860	28,40
1/4 - 20	265	162	20	0,69	236	486862	8,69
1/4 - 40	265	162	40	1,37	286	486864	10,02
1/4 - 65	265	162	65	1,60	355	486866	10,85
1/4 - 100	265	162	100	2,80	449	486868	13,20
1/4 - 150	265	162	150	4,20	559	486870	19,29
1/4 - 200	265	162	200	5,80	644	486872	24,31
1/6 - 20	176	162	20	0,46	167	486874	7,48
1/6 - 40	176	162	40	0,90	236	486876	9,10
1/6 - 65	176	162	65	1,00	267	486878	9,86
1/6 - 100	176	162	100	1,80	346	486880	11,25
1/6 - 150	176	162	150	2,40	398	486882	18,00
1/6 - 200	176	162	200	2,60	640	486884	28,40
1/9 - 65	176	108	65	0,50	195	486886	9,07
1/9 - 100	176	108	100	0,90	230	486888	13,09

Cubetas Gastronorm perforadas

Perforated Gastronorm containers
Bacs Gastronorm perforé

Modelo Model Model	L	A	H				€
2/1 - 40	650	530	40	10,50	2.764	487002	54,00
2/1 - 65	650	530	65	18,50	3.087	487004	61,00
2/1 - 100	650	530	100	28,00	3.480	487006	84,00
2/1 - 150	650	530	150	42,00	3.870	487008	121,00
2/1 - 200	650	530	200	56,50	4.480	487010	142,00
1/1 - 40	530	325	40	5,50	1.320	487012	23,00
1/1 - 65	530	325	65	9,50	1.305	487014	25,00
1/1 - 100	530	325	100	14,00	1.570	487016	36,00
1/1 - 150	530	325	150	21,00	1.820	487018	55,00
1/1 - 200	530	325	200	28,00	2.053	487020	65,00
2/3 - 40	354	325	40	3,20	757	487022	18,00
2/3 - 65	354	325	65	5,50	790	487024	19,00
2/3 - 100	354	325	100	8,70	1.051	487026	27,00
2/3 - 150	354	325	150	13,00	1.278	487028	43,00
2/3 - 200	354	325	200	18,00	1.500	487030	50,00
1/2 - 40	325	265	40	2,20	598	487032	14,00
1/2 - 65	325	265	65	3,70	660	487034	15,50
1/2 - 100	325	265	100	6,50	745	487036	20,00
1/2 - 150	325	265	150	9,50	890	487038	32,00
1/2 - 200	325	265	200	12,50	1.275	487040	42,00

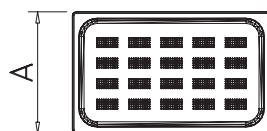
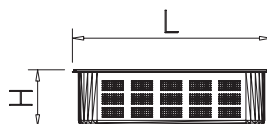

Tapas para cubetas Gastronorm

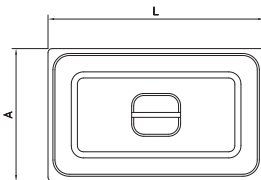

Lid for Gastronorm containers
Couvercle pour bacs Gastronorm

Modelo Model Model	L	A			€
1/1	530	325	1.100	487202	20,00
2/3	354	325	662	487204	14,22
2/4	530	162	331	487216	13,74
1/2	325	265	500	487206	12,16
1/3	325	176	350	487208	10,00
1/4	265	162	255	487210	8,50
1/6	176	162	180	487212	7,50
1/9	176	108	110	487214	7,00



Tapas herméticas para cubetas Gastronorm

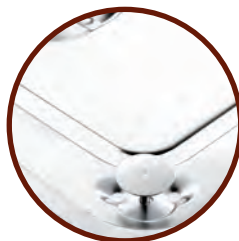

Gastronorm form fitting seal lids
Couvercle hermétique pour bacs Gastronorm

Modelo Model Model			€
1/1	1.150	487232	58,00
1/2	540	487234	41,00
1/3	380	487236	35,00
1/4	275	487238	28,00
1/6	195	487240	25,00
2/3	680	487242	43,40



Fondos perforados para cubetas Gastronorm

Perforated bottoms for Gastronorm containers
Fonds pour bacs Gastronorm

Modelo Model Model	L	A	H			€
2/1	650	530	10	2,0	487250	36,34
1/1	530	325	10	1,0	487252	20,00
2/3	354	325	10	0,6	487254	17,00
1/2	325	265	10	0,5	487256	14,00

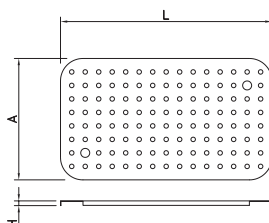



BPA o Bisphenol A es una sustancia tóxica presente en algunas cubetas, biberones y otros elementos de plástico. Se libera principalmente al calentar estos productos tanto en microondas o al esterilizarlos en agua de manera convencional.

BPA FREE garantiza que este producto no está fabricado con BPA.

BPA or Bisphenol A is a toxic substance that is present in some containers, feeding bottles and other plastic elements. It is particularly released when these materials are heated in a microwave or conventionally sterilized in water.

BPA FREE guarantees that this product does not contain BPA.

BPA ou Bisphénol A est une substance toxique qui est présent dans certains bacs, biberons et des autres éléments en plastique. Il est particulièrement libérée lorsque ces produits sont chauffés dans un four micro-ondes ou sont stérilisés dans l'eau de façon conventionnelle.

BPA FREE garantit que ce produit ne contient pas de BPA.

Cubetas Gastronorm polycarbonato

Gastronorm containers in polycarbonate
Bacs Gastronorm en polycarbonate

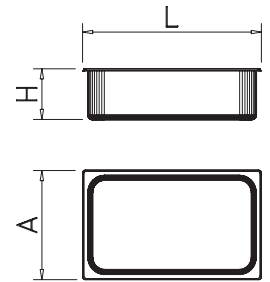

Ver pag. 414
See page 414
Voir page 414



Modelo Model Model	L	A	H		Gr		€
2/1 - 200	650	530	200	10,50	2.400	487602	50,70
1/1 - 65	530	325	65	9,50	700	487604	16,70
1/1 - 100	530	325	100	14,00	800	487606	19,30
1/1 - 150	530	325	150	21,00	980	487608	23,00
1/1 - 200	530	325	200	28,00	1.145	487610	27,00
1/2 - 65	325	265	65	3,70	330	487612	8,70
1/2 - 100	325	265	100	6,50	410	487614	9,30
1/2 - 150	325	265	150	9,50	470	487616	11,20
1/2 - 200	325	265	200	12,50	675	487618	13,80
1/3 - 65	325	176	65	2,50	240	487620	7,20
1/3 - 100	325	176	100	3,70	290	487622	8,00
1/3 - 150	325	176	150	5,70	350	487624	9,60
1/3 - 200	325	176	200	7,70	390	487626	11,50
1/4 - 65	265	162	65	1,60	180	487628	5,70
1/4 - 100	265	162	100	2,80	230	487630	6,60
1/4 - 150	265	162	150	4,20	280	487632	8,30
1/4 - 200	265	162	200	5,80	325	487634	10,00
1/6 - 65	176	162	65	1,00	135	487636	4,30
1/6 - 100	176	162	100	1,80	175	487638	5,20
1/6 - 150	176	162	150	2,40	200	487640	6,20
1/6 - 200	176	162	200	2,60	325	487642	7,60
1/9 - 65	176	108	65	0,50	100	487644	3,50
1/9 - 100	176	108	100	0,90	120	487646	4,00

Tapas para cubetas Gastronorm policarbonato
 Lids for Gastronorm containers in polycarbonate
 Couvercle pour bacs Gastronorm en polycarbonate



Ver pag. 414
 See page 414
 Voir page 414

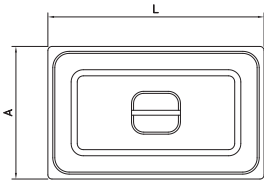

Modelo Model Model	L	A	Gr	Barcode	€
2/1	650	530	920	487218	29,50
1/1	530	325	660	487220	11,40
1/2	325	265	300	487222	7,00
1/3	325	176	210	487224	6,50
1/4	265	162	153	487226	6,50
1/6	176	162	110	487228	5,60
1/9	176	108	70	487229	4,80

Fondos perforados para cubetas Gastronorm policarbonato
 Perforated bottom for Gastronorm containers in polycarbonate
 Fond pour bacs Gastronorm en polycarbonate

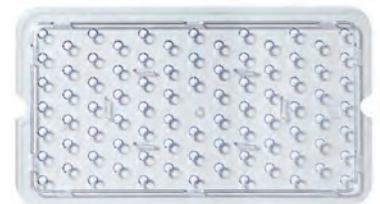

Ver pag. 414
 See page 414
 Voir page 414

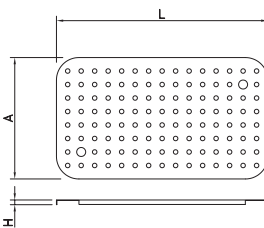

Modelo Model Model	L	A	H	Gr	Barcode	€
2/1	650	530	10	200	487258	17,20
1/1	530	325	10	550	487260	7,30
1/2	325	265	10	250	487262	4,50

Cubetas Gastronorm alta temperatura

Gastronorm containers high temperatures
Bacs Gastronorm hautes températures

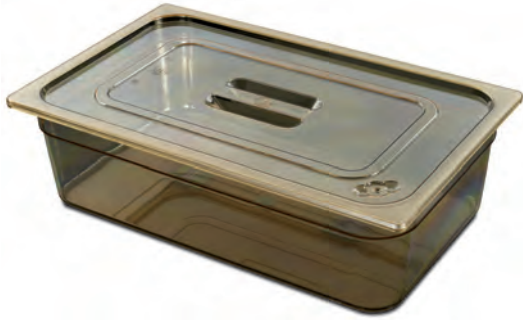

Ver pag. 414
See page 414
Voir page 414

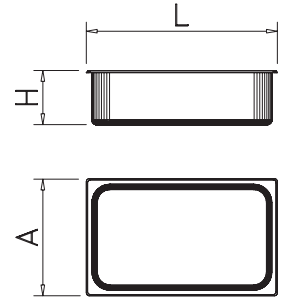

Características:

Fabricado con materiales de conformidad con la FDA.
Cumple con la normativa UNI EN 631-1.
BPA Free.

Sus principales cualidades son su gran resistencia a los golpes, identificación cómoda del contenido al poder ver a través de ellas, equipadas con una escala graduada con el sistema métrico y americano, preparadas para ser apiladas, fácil de limpiar, higienizables.

Resistentes a temperaturas de -40°C a +150 °C.
Ideales para hornos microondas, baños maria etc.

Characteristics:

Made with FDA-approved materials.
Designed and manufactured in compliance with the UNI EN 631-1 Free of Bisphenol A BPA Free.
The type of materials and thicknesses of the containers guarantee a perfect shock-resistance; they cannot easily be dented in case of accidental spills.
Completely smooth walls which allows for easily identification of the internal content and facilitates easy washing.
Equipped with a graded scale according both the metric and American system.
Edges for easy stacking.
Available with easy to place over lids.
Easy to clean and sanitizable.
Can withstand temperatures from -40 °C +150 °C.
Ideal for microwave ovens, bain-marie and general warming facilities.

Caractéristiques:

Fabriqué à la conformité de la FDA.
Conforme à la norme UNI EN 631-1.
BPA Free.
Ses principales qualités sont sa haute résistance aux chocs, l'identification du contenu pratique de pouvoir voir à travers eux, avec un gradient équipé d'un système métrique et américain, prêt à être empilés, facile à nettoyer, à l'échelle de higienizables.
Résistant de -40 °C à +150 °C. Température.
Idéal pour les fours à micro-ondes, des bains d'eau, etc..

Modelo Model Model	L	A	H		Gr		€
1/1 - 65	530	325	65	9,50	1.365	488002	42,00
1/1 - 100	530	325	100	14,00	1.652	488004	54,00
1/1 - 150	530	325	150	21,00	1.965	488006	70,00
1/2 - 65	325	265	65	3,70	663	488008	26,00
1/2 - 100	325	265	100	6,50	818	488010	30,00
1/2 - 150	325	265	150	9,50	944	488012	38,00
1/3 - 65	325	176	65	2,50	488	488014	19,00
1/3 - 100	325	176	100	3,70	581	488016	24,00
1/3 - 150	325	176	150	5,70	698	488018	29,00
1/4 - 65	265	162	65	1,60	355	488020	15,00
1/4 - 100	265	162	100	2,80	449	488022	18,00
1/4 - 150	265	162	150	4,20	559	488024	23,00
1/6 - 65	176	162	65	1,00	267	488026	11,00
1/6 - 100	176	162	100	1,80	346	488028	14,00
1/6 - 150	176	162	150	2,40	398	488030	17,00
1/9 - 65	176	108	65	0,50	195	488032	7,00
1/9 - 100	176	108	100	0,90	230	488034	9,00

Tapas para cubetas Gastronorm alta temperatura

Lids for Gastronorm containers high temperatures
Couvercle pour bacs Gastronorm hautes températures

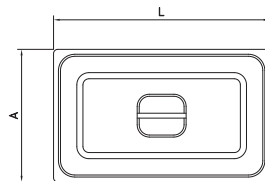
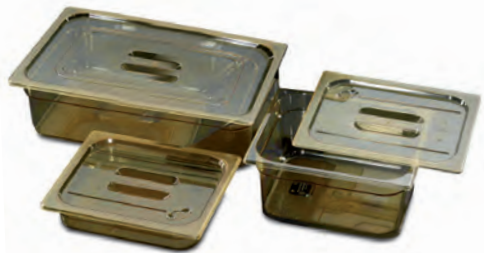

Ver pag. 414
See page 414
Voir page 414



Modelo Model Model	L	A	Gr		€
1/1	530	325	1.100	488070	38,00
1/2	325	265	500	488072	19,00
1/3	325	176	350	488074	13,00
1/4	265	162	255	488076	11,00
1/6	176	162	180	488078	9,00
1/9	176	108	110	488080	6,00

Fondos perforados para cubetas Gastronorm alta temperatura

Perforated bottoms for Gastronorm containers high temperatures
Fonds perforé pour bacs Gastronorm hautes températures

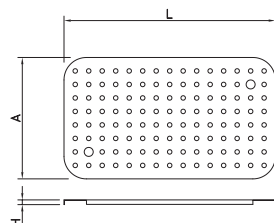
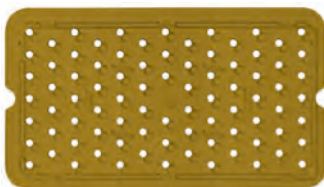

Ver pag. 414
See page 414
Voir page 414



Modelo Model Model	L	A	H	Gr		€
1/1	530	325		1.000	487264	21,00
1/2	325	265		500	487266	13,00

Cubetas GN para identificación de alérgenos

Gastronorm containers for allergen marking
Cuvettes GN pour identification d'allergènes

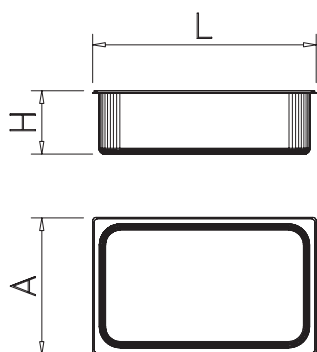

Novedad
ew
ouveau

Modelo Model Model	L	A	H	lit	Gr	Barcode	€
1/1 - 65	530	325	65	9,00	700	488402	9,50
1/1 - 100	530	325	100	13,30	800	488404	11,00
1/1 - 150	530	325	150	20,00	980	488406	12,00
1/1 - 200	530	325	200	26,40	1.145	488408	14,00
1/2 - 65	325	265	65	4,00	330	488410	6,00
1/2 - 100	325	265	100	6,10	410	488412	7,00
1/2 - 150	325	265	150	9,00	470	488414	8,00
1/2 - 200	325	265	200	11,90	975	488416	9,00
1/3 - 65	325	176	65	2,50	240	488418	5,00
1/3 - 100	325	176	100	3,80	290	488420	6,00
1/3 - 150	325	176	150	5,50	350	488422	7,00
1/3 - 200	325	176	200	7,10	390	488424	8,00
1/4 - 65	265	162	65	1,70	180	488426	4,50
1/4 - 100	265	162	100	2,60	230	488428	5,00
1/4 - 150	265	162	150	3,80	280	488430	6,00
1/4 - 200	265	162	200	4,80	325	488432	7,00
1/6 - 65	176	162	65	1,00	135	488434	4,00
1/6 - 100	176	162	100	1,60	175	488436	4,60
1/6 - 150	176	162	150	2,30	200	488438	5,30
1/6 - 200	176	162	200	2,80	325	488440	5,60
1/9 - 65	176	108	65	0,60	100	488442	3,30
1/9 - 100	176	108	100	0,90	120	488444	4,00

Características:

La nueva línea de cubetas para identificación de alérgenos Gastronorm es una valiosa ayuda para todos los lugares donde pueden ser utilizadas, hoteles, restaurantes, clínicas, hospitales..., para asegurar un alto nivel de servicio a sus clientes o pacientes, cumpliendo con todas las normativas.

En diciembre de 2014 entró en vigor la nueva normativa EU 1169/2011 sobre el etiquetado de los productos alimenticios. Tiene como objetivo garantizar un elevado nivel de protección del consumidor en el campo de información de alimentos. Este Reglamento introduce, entre otras cosas, la obligación de los restaurantes a proporcionar información detallada a los clientes sobre la presencia de sustancias alergénicas contenidas en los alimentos.

Characteristics:

The new line of Gastronorm containers with allergen identifying labels is a valuable assistance for any place where they can be used, such as hotels, restaurants, clinics, hospitals ..., to ensure a high level of service to their customers or patients. It will comply with all regulations.

In December 2014, the new EU regulation 1169/2011, on labeling of foodstuffs, came into force, with the aim of guaranteeing a high level of consumer protection in the field of food information. This Regulation introduces, among other things, the obligation of restaurants to provide detailed information to customers about the presence of allergenic substances contained in food.

Caractéristiques:

La nouvelle gamme de cuvettes GN pour identification d'allergènes sera d'une aide précieuse pour tous les endroits où ils peuvent être utilisés, hôtels, restaurants, cliniques, hôpitaux ..., pour assurer un haut niveau de service à leurs clients, patients, en respectant toutes les réglementations.

En décembre 2014, le nouveau règlement 1169/2011 de l'UE sur l'étiquetage des denrées alimentaires est entré en vigueur, dans le but de garantir un niveau élevé de protection des consommateurs dans le domaine de l'information sur les denrées alimentaires. Ce règlement introduit, entre autres, l'obligation des restaurants de fournir des informations détaillées aux clients sur la présence de substances allergènes contenues dans les aliments.

Tapa para cubetas GN para identificación de alérgenos

Lid for Gastronorm containers for allergen marking
Couvercle pour Cuvettes GN pour identification d'allergènes

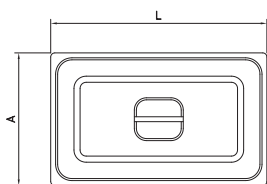

Novedad
ew
ouveau

Modelo Model Model	L	A	Gr	Barcode	€
1/1	530	325	660	488460	5,00
1/2	325	265	300	488462	3,00
1/3	325	176	210	488464	2,80
1/4	265	162	153	488466	2,60
1/6	176	162	110	488468	2,30
1/9	176	108	70	488470	2,10

Recipientes de polipropileno

Containers in polypropylene
Bacs en polypropylene

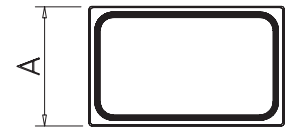
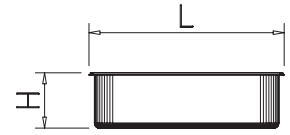

Características:

Fabricadas con materiales en conformidad con la FDA.
Solución económica para la preparación, almacenamiento y exposición de los alimentos.
Buena transparencia que permite fácilmente la identificación del contenido interior.
Resistente a temperaturas de -40 °C a +80 °C.
Equipado con una escala graduada con los sistemas métrico y estadounidense.
Apilables.

Characteristics:

Made with FDA-approved materials.
Excellent economical solution for the preparation, display and storage of food.
Excellent shock resistance at room temperature.
Good transparency allowing easily identification of the inside contents. Can withstand temperatures from -40 °C to +80 °C.
Equipped with a graded scale according both the American and metric systems.
Edges for easy stacking.
Available with transparent or colored hermetic lids.

Caractéristiques:

Fabriqué avec des matériaux conformes à la FDA.
Solution économique pour la préparation, le stockage et l'affichage de la nourriture.
Bonne transparence qui permet l'identification facile du contenu à l'intérieur.
Résistant à des températures de -40 °C à +80 °C.
Équipé d'un diplôme de niveau des systèmes métrique et US.
Empilable.

Modelo Model Model	L	A	H		Gr		€
1/1 - 65	530	325	65	9,50	700	488202	7,20
1/1 - 100	530	325	100	14,00	800	488204	8,50
1/1 - 150	530	325	150	21,00	980	488206	9,70
1/1 - 200	530	325	200	28,00	1.145	488208	12,00
1/2 - 65	325	265	65	3,70	330	488210	4,10
1/2 - 100	325	265	100	6,50	410	488212	4,50
1/2 - 150	325	265	150	9,50	470	488214	5,70
1/2 - 200	325	265	200	12,50	675	488216	6,50
1/3 - 65	325	176	65	2,50	240	488218	3,30
1/3 - 100	325	176	100	3,70	290	488220	3,80
1/3 - 150	325	176	150	5,70	350	488222	5,00
1/3 - 200	325	176	200	7,70	390	488224	5,60
1/4 - 65	265	162	65	1,60	180	488226	3,00
1/4 - 100	265	162	100	2,80	230	488228	3,40
1/4 - 150	265	162	150	4,20	280	488230	4,40
1/4 - 200	265	162	200	5,80	325	488232	4,95
1/6 - 65	176	162	65	1,00	135	488234	2,60
1/6 - 100	176	162	100	1,80	175	488236	2,75
1/6 - 150	176	162	150	2,40	200	488238	3,71
1/6 - 200	176	162	200	2,60	325	488240	4,26
1/9 - 65	176	108	65	0,50	100	488242	2,34
1/9 - 100	176	108	100	0,90	120	488244	2,48

Tapas para recipientes de polipropileno

Lids for containers in polypropylene
Couvercles pour bacs en polypropylene

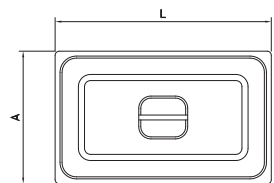
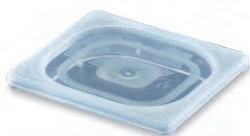

Modelo Model Model	L	A	Gr		€
1/1	530	325	660	488270	3,50
1/2	325	265	300	488272	2,20
1/3	325	176	210	488274	1,80
1/4	265	162	153	488276	1,60
1/6	176	162	110	488278	1,30
1/9	176	108	70	488280	1,20

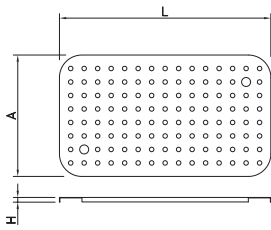

Fondos perforados para recipientes de polipropileno

Perforated bottoms for containers in polypropylene
Fonds pour bacs en polypropylène



Modelo Model Model	L	A	H	Gr	Barcode	€
1/1	530	325	10	550	487268	3,50
1/2	325	265	10	250	487269	2,50

Tapas de polipropileno GN de colores

Polypropylene colored Gastronorm lids
Couvercles en polypropylène GN plusieurs couleurs

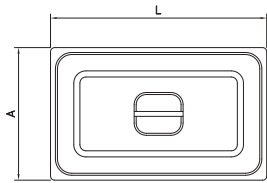

Novedad
New
Nouveau

Modelo Model Model	L	A	Gr	Color	Barcode	€
1/1	530	325	660	Red	488302	5,00
				Blue	488304	
				Yellow	488306	
				Green	488308	
1/2	325	265	300	Red	488310	2,40
				Blue	488312	
				Yellow	488314	
				Green	488316	
1/3	325	176	210	Red	488318	1,95
				Blue	488320	
				Yellow	488322	
				Green	488324	
1/4	265	162	153	Red	488326	1,65
				Blue	488328	
				Yellow	488330	
				Green	488332	
1/6	176	162	110	Red	488334	1,40
				Blue	488336	
				Yellow	488338	
				Green	488340	
1/9	176	108	70	Red	488342	1,10
				Blue	488344	
				Yellow	488346	
				Green	488348	

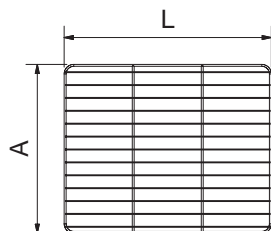

Rejillas Gastronorm

Gastronorm grilles
Grilles gastronorm



Modelo Model Model	L	A	V Kg	Kg	Barcode	€
2/1	650	530	71	1,97	487270	47,00
1/1	530	325	45	0,89	487272	27,00
1/2	325	265	31	0,48	487274	19,00
Euronorm	600	400	17	0,88	487276	26,00

Perfiles divisorios para cubetas Gastronorm

Dividing section for Gastronorm containers
Profil diviseur pour cuveaux Gastronorm

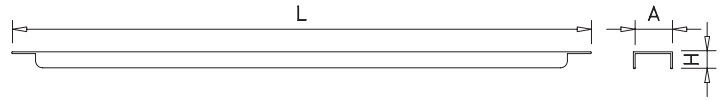
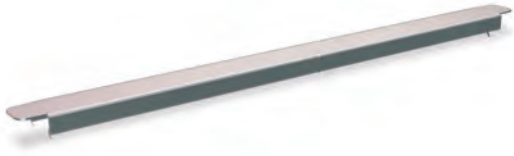

L	A	H	Gr	Barcode	€
325	22	9,8	86	082820	4,00
530	22	9,8	146	082822	5,50

Contenedor Gastronorm aislamiento térmico

Gastronorm container for thermic isolation
Bac Gastronorm d'isolation thermique

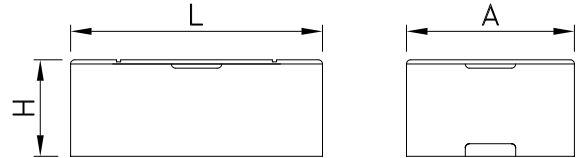
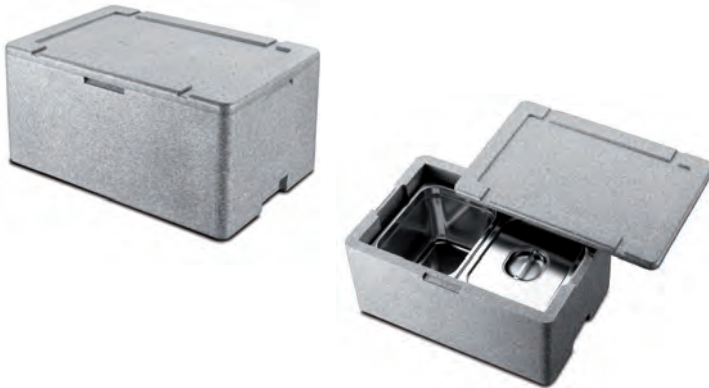

Modelo Model Model	L	A	H	Gr	Barcode	€
1/1 - 120	600	400	170	550	487802	52,00
1/1 - 170	600	400	230	620	487804	56,00
1/1 - 220	600	400	270	710	487806	61,00

Asa universal para cubetas Gastronorm

Standard handle for Gastronorm containers
Manche universel pour bacs Gastronorm



Introducing the fastest, safest and cleanest way to place and remove insert pans at your food service facilities.

A tool that ends the injuries and food contamination that may occur when kitchen staff and food servers switch out pans at steam tables and buffet lines.
Heavy gauge stainless steel construction.
Pan removers lock-on when pushed inward and won't slip, allowing a steady and safe handling.
Prevents burns and pinched or broken fingers at hot tables.
Prevents food contamination.
Easy to use.
Dishwasher safe.

Nous présentons la forme la plus rapide, secrete, et propre de placer et retirer cuveaux dans vos équipements de restauration.

Un outil qui finit avec les accidents et avec la contamination alimentaire qu'il peut se produire quand les cuisiniers et serveurs retirent des cuveaux du bain-marie et des buffets.
Construction en acier inoxydable à grand épaisseur.
L'anse se bloque quand est pressé vers dehors et ne se glisse pas.
Prévient des brûlures et des doigts coincés dans les tables chaudes.
Prévient la contamination alimentaire.
Facile à user.
Bon pour le lave-vaisselles.

Presentamos la forma más rápida, segura y limpia de colocar y retirar cubetas de sus equipamientos de restauración.



Una herramienta que acaba con los accidentes y con la contaminación alimentaria que pueden producirse cuando cocineros y camareros sacan cubetas de los baños maría y buffets.
Construcción en acero inoxidable de gran espesor.
El asa se bloquea cuando es presionada hacia dentro y no se desliza, garantizando una

maniobrabilidad firme y segura.
Previene quemaduras y dedos aplastados en las mesas calientes.
Previene la contaminación alimentaria.
Fácil de usar.
Apto para lavavajillas.

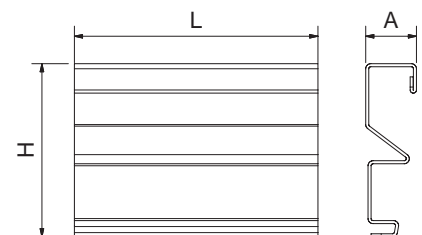

L	A	H	Gr	Barcode	€
120	25	85	200	082802	20,00



El precio es por pareja.
The pair is included in the price.
Le paire est inclus dans de prix.

Contenedor isotermo
Isothermal food container
Thermos

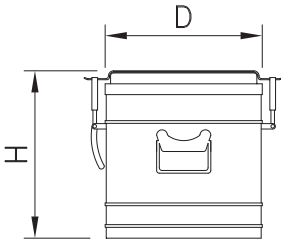

Modelo Model Model	D	H				€
	355	320	10	9,0	480246	665,00
	425	420	25	14,0	480248	833,00
	355	320	10	9,4	480247	775,00
	425	420	25	14,4	480249	943,00

Cubeta de inducción
Induction container
Bac d'induction

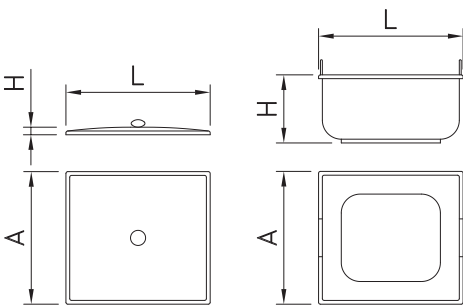

Modelo Model Model	L	A	H			€	
	382	351	180	3,7	487820	96,00	
	1/3	325	176	150	0,81	487824	96,00
	2/3	354	325	150	1,14	487826	162,00
	382	351	20	1,04	487822	25,00	

Bandejas de presentación inox

Stainless steel presentation trays
Plateaux de présentation en acier inoxydable

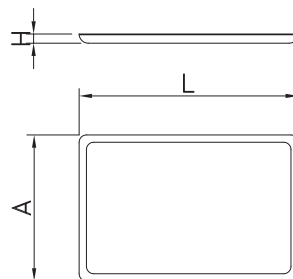

L	A	H	Gr	Barcode	€
250	200	20	320	480675	10,00
320	260	20	530	480676	13,00
360	290	20	670	480677	17,00
400	320	20	820	480678	20,00
500	400	20	1.280	480679	31,00

Bandejas de presentación

Presentation trays
Plateaux de présentation

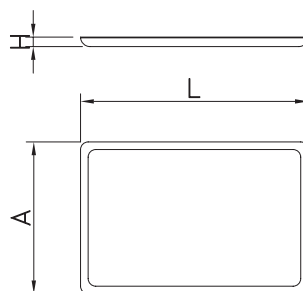

L	A	H	Gr	Barcode	€
600	400	25	1.090	480690	16,50
280	190	12	320	480692	6,00
350	240	12	400	480694	10,70
420	300	12	500	480696	14,00

Bandeja antideslizante Gastronorm 1/1

Non-slip Gastronorm tray 1/1
Bac Gastronorm antidérapant 1/1

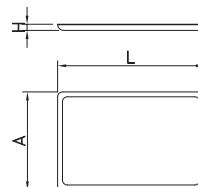

L	A	H	Gr	Barcode	€
530	325	30	150	480686	19,00

Bandejas de presentación BP1

Presentation tray BP1
Plateau de présentation BP1



Novedad
New
Nouveauté

Material polipropileno 100% alimentario.

Polypropylene material, totally food-safe.

Matériaux 100% polypropylène.

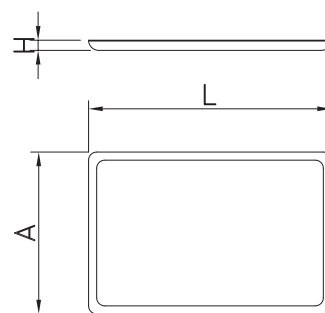

L	A	H	Gr	Barcode	€
345	270	22	200	480730	4,00
415	305	22	400	480750	5,00
456	356	22	500	480760	6,00

Bandejas de presentación BP2

Presentation tray BP2
Plateau de présentation BP2

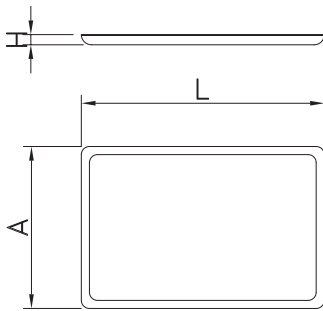

Material polipropileno 100% alimentario.

Polypropylene material, totally food-safe.

Matériaux 100% polypropylène.



L	A	H	Gr	Barcode	€
430	310	31	400	480740	5,00

Bandeja Gastronorm de presentación BP3

Gastronorm presentation tray BP3
Plateau Gastronorm de présentation BP3

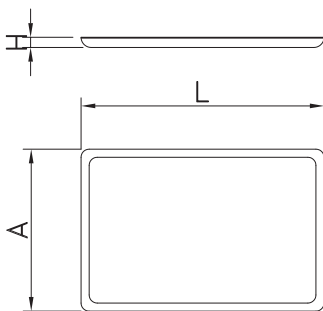

Material polipropileno 100% alimentario.

Polypropylene material, totally food-safe.

Matériaux 100% polypropylène.



L	A	H	Gr	Barcode	€
530	325	14	600	480770	9,00

Bandeja inoxidable con asa

Stainless steel tray with handle
Plateau en acier inoxydable avec manche

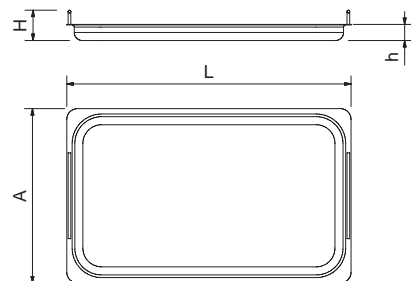

Modelo	L	A	H	h	Gr	Barcode	€
2/1	650	530	60	20	2.920	480670	53,00
1/1	530	325	60	20	1.300	480672	33,00
2/3	354	325	60	20	900	480674	30,00

Bandeja menú inoxidable

Stainless steel menu trays
Plateau repas en acier inoxydable

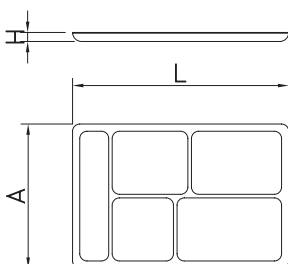

L	A	H	Gr	Grid	Barcode	€
400	300	30	844	4	482802	23,00
440	350	30	1.106	5	482804	24,00

Bandejas de camarero

Waiter trays
Plateaux de serveur

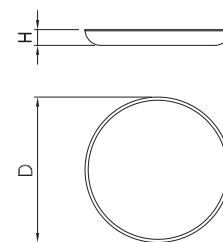

D	H	Gr	Barcode	€
310	20	350	480640	19,00
360	20	600	480642	22,00
410	20	800	480644	30,00

Bandeja de camarero especial jarras de cerveza

Trays for beer
Plateau garçon de café spécial pour pichet de bière



Novedad
nouveau

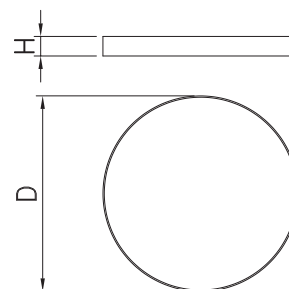

D	H	Gr	Barcode	€
300	30	560	480646	31,00
400	40	920	480648	42,00

Bandeja de cambio sencilla

Simple change tray
Porte-pourboire simple

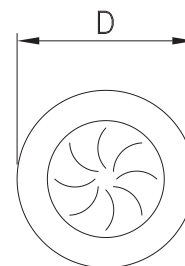

D	Gr	Barcode	€
120	10	486230	1,00

Bandeja de cambio

Change tray
Porte-pourboire

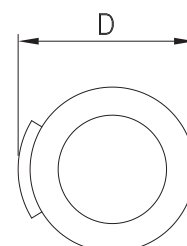

D	Gr	Barcode	€
130	11	486234	1,80

Bandeja de cambio rectangular con clip
 Rectangular change tray
 Porte-pourboire rectangulaire avec clip

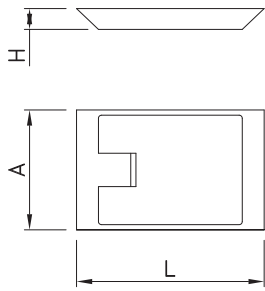

L	A	H	Gr	Barcode	€
180	115	20	20	486232	1,80

Bandejas aluminio antiadherente
 Non-stick aluminium tray
 Plateaux aluminium anti-adhérent

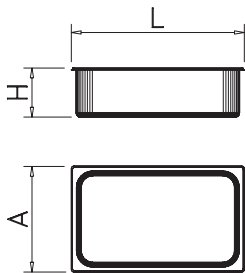

Modelo Model Model	L	A	H	Gr	Barcode	€
1/1	530	325	20	720	480702	33,00
1/1	530	325	40	800	480704	36,00
1/1	530	325	65	880	480706	44,00
2/3	354	325	20	510	480708	22,00
2/3	354	325	40	570	480710	25,00
2/3	354	325	65	650	480712	30,00
1/2	325	265	20	420	480714	19,00
1/2	325	265	40	450	480716	21,00
1/2	325	265	65	520	480718	25,00

Bandeja pastelera en acero inoxidable
 Stainless steel baking tray
 Plateau à pâtisserie en acier inoxydable

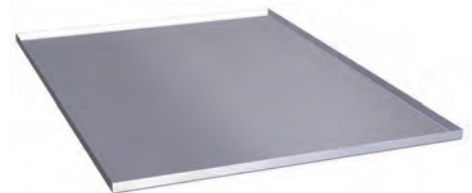

No diseñadas para contener líquidos
 Not intended to contain liquids
 Ne sont pas conçues pour contenir des liquides

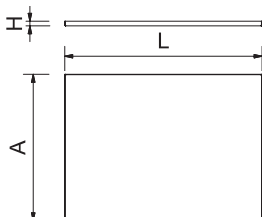

Bordes doblados a 90°
 Edges bent at 90°
 Rebord aplati à 90°

L	A	H	Kg	Barcode	€
300	400	9,5	0,8	083402	17,00
600	400	14,0	1,7	083404	23,00

Bandeja panadería en malla inox

Wire mesh baguette tray. Stainless steel
Plateau cuisson pour baguette en fil inox



Caractéristiques:

Le support grandes mailles est conçu pour la cuisson du pré-cuit.
Cadre en fil plein Ø 7 et 8 mm en inox 304
Toile en inox 304
Vide de maille 12,5 x 12,5 mm
100% recyclable.

Características:

Bandeja de varilla y malla de acero inoxidable para pan pre-cocido.
Estructura de varilla de 7 y 8 mm de acero inoxidable.
Totalmente fabricada en acero inoxidable AISI 304.
Malla de 12,5 x 12,5 mm.
100% reciclable.

Characteristics:

Ø 7 and 8 - 304 stainless steel solid wire frame.
304 stainless steel sheet.
12,5 x 12,5 mm empty mesh space.
Only available without coating.
Designed for pre-baking operations.
100% recyclable.

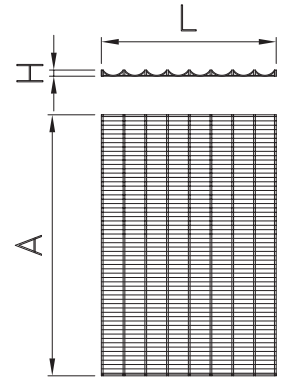

L	A	H		Kg		€
400	600	45	5	0,16	480632	66,00

Bandeja pastelera perforada

Perforated pastry baking tray
Plaque pâtisseries perforée

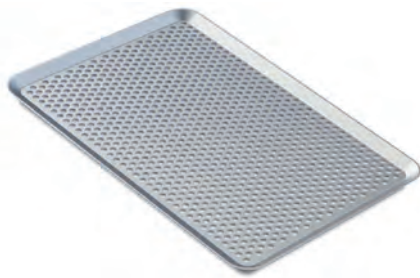

Aluminio reforzado AG5
Espesor 1,5 mm
4 esquinas a 45°
Perforaciones de Ø 6 mm.

AG5 hard aluminium
4 edges at 45°
Thickness 1,5 mm
With Ø 6 mm perforation

Aluminium AG5 dur
Épaisseur 1,5 mm
4 bords à 45°
Avec perforation Ø 6

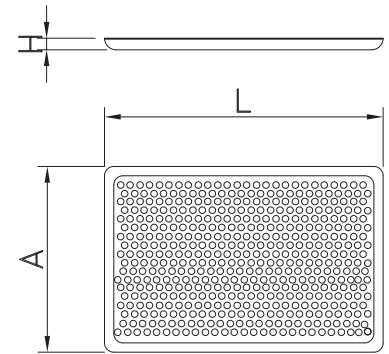

L	A	H	Gr		€
600	400	12	500	480630	20,00

Bandeja para marisco

Seafood tray
Plateau inox pour fruits de mer

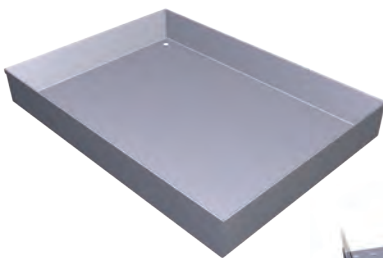

Características:

Sistema modular para un perfecto acoplamiento y organización de la exposición del género en el mostrador de pescadería.
Provista de agujeros a modo de desagüe.
Construida totalmente en acero inoxidable.

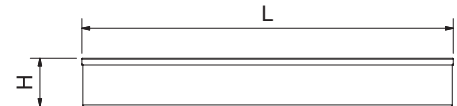

Characteristics:

Modular system for a perfect fit and organization of the exhibition of goods in the fish counter.
With holes for the drain pipe.
Built entirely in stainless steel.

Caractéristiques:

Système modulaire pour l'organisation de la marchandise sur l'étal à poisson.
Avec trous pour le drainage.
Fabriqué totalement en acier inoxydable.

L	A	H	Kg		€
480	287	50	1,35	083420	35,00

Cestas alimentarias
Food baskets
Paniers alimentaires

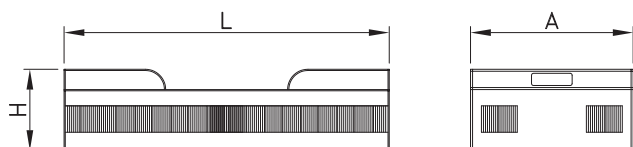

L	A	H		Gr		€
600	400	120		1,15	483008	13,50
600	400	200		1,75	483010	18,00
500	300	200		1,17	483012	14,00

Cesta alimentaria plegable
Foldable food basket
Paniers alimentaires pliables

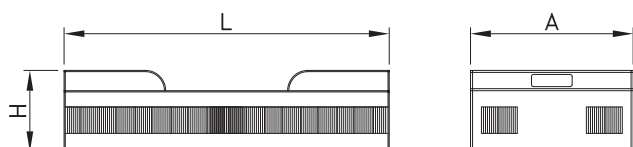
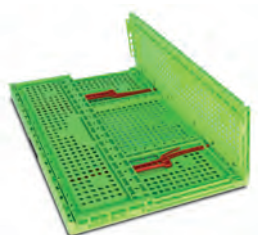
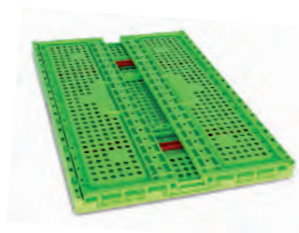

L	A	H	Gr		€
600	400	200	1,82	483014	21,00

Caja alimentaria apilable

Stackable box for food use
Boîte alimentaire empilable



Caractéristiques:

Fabriqué en polyéthylène alimentaire.
Résiste aux températures de -40° à + 80° et jusqu'à + 120° pendant le lavage.
Parfait pour l'entretien et la conservation de la pâte à pizza.
N'absorbe pas les odeurs.
Nettoyage facile.
Légère et résistante.
Empilable pour empêcher la poussière et les impuretés d'entrer.
Apte pour le lave-vaisselle.

Características:

Fabricadas en polietileno alimentario.
Resistentes a temperaturas de -40° a + 80° y hasta + 120° durante el lavado.
Perfecto para el mantenimiento y la conservación de la masa de pizza.
No absorbe olores.
Fácil limpieza.
Ligeras y resistentes.
Apilables para evitar la entrada de polvo e impurezas.
Aptas para el lavavajillas.

Characteristics:

Made of alimentary polyethylene.
Suitable for food contact.
Closed-end and ribbed bottom.
Closed sides.
Resistant to temperatures from -40° to +80° and up to +120° during washing.
Perfect for the maintenance and preservation of the pizza dough.
Ideal for storage.
Made for not absorb odours and easy to clean.
Resistant and light weighted.
Stackable so as to prevent the entry of dust and impurities.
Dishwasher safe.



L	A	H	Kg	Barcode	€
400	300	100	0,75	440742	16,00
600	400	100	1,50	440736	18,00
600	400	130	1,65	440738	22,00

Tapa para caja alimentaria apilable

Lid for stackable food box
Couvercle pour boîte alimentaire empilable

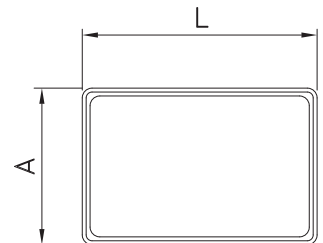

L	A	Gr	Barcode	€
400	300	450	440744	9,00
600	400	900	440740	11,00

Cesta de supermercado sencilla

Simple shopping basket
Panier supermarché simple

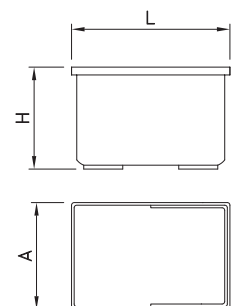

L	A	H	Gr	Barcode	€
430	300	220	600	481052	18,00

Cesta supermercado
Market basket
Panier à provisions

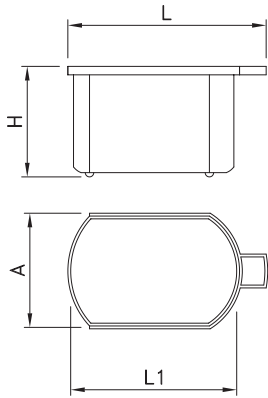

Características:
Fabricada en polipropileno.
Apilables.

Characteristics:
Manufactured in polypropylene.
Stackable.

Caractéristiques:
Fabriqué en polypropylène.
Empilable.



L	L1	A	H	lit	Kg	Barcode	€
610	505	365	392	42	1,50	481050	36,00

Cesta simple
Rack basket
Panier

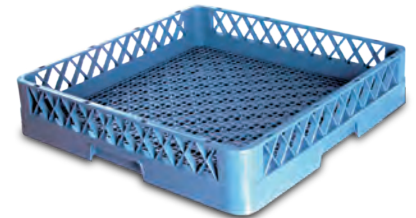
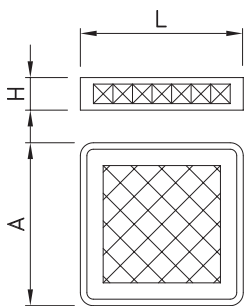

L	A	H	Kg	Barcode	€
500	500	102	1,22	483004	21,00

Extensión cesta simple
Rack basket extension
Extension de panier

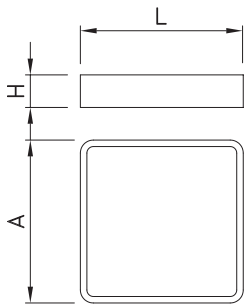

L	A	H	Kg	Barcode	€
500	500	40	0,46	483006	13,50

Cesta para platos
Dishwasher plate rack basket
Panier de lavage pour assiettes

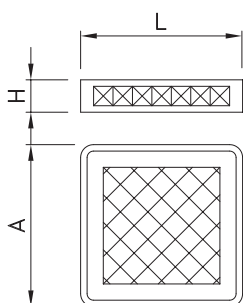

L	A	H	Kg	Barcode	€
500	500	102	1,32	483002	24,00

Plataforma con freno para transporte de cestos de lavavajillas

Cart for racks with break
Plate-forme pour transport de paniers de lave-vaisselle



Novedad
ew
ouveau

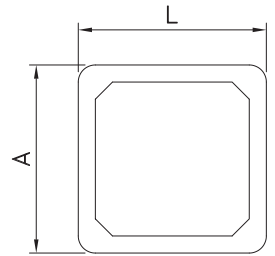

L	A	Kg	Barcode	€
550	550	2,65	483016	106,00

Tapa para cubrir cestos de lavavajillas

Lid cover for racks
Couvercle pour boîte alimentaire empilable



Novedad
ew
ouveau

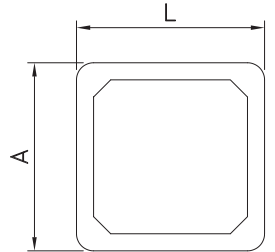

L	A	Gr	Barcode	€
550	550	400	483018	44,00

Cestos de vasos para lavavajillas

Dishwasher rack for glasses
Paniers pour verres pour lave-vaisselle



Novedad
ew
ouveau

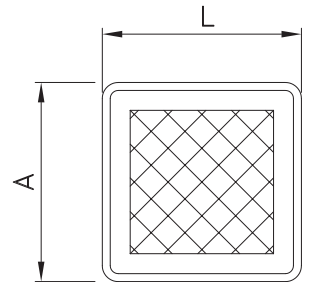

L	A	H	Glass	Kg	Barcode	€
			25	1,55	483020	27,00
500	500	102	36	1,67	483022	32,00
			49	1,82	483024	37,00

Cestillo para cubiertos

Cutlery basket
Couverts panier

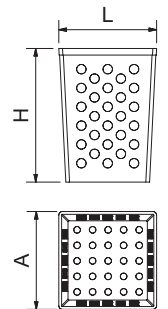
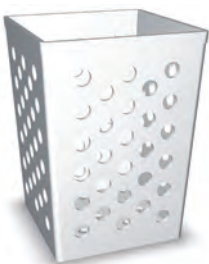

L	A	H	Gr	Barcode	€
105	105	145	95	454860	3,00

Cubertero

Cutlery holder
Porte-couverts

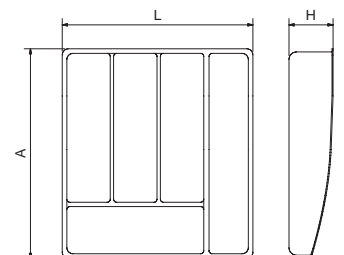
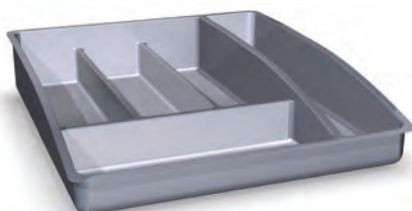

L	A	H	Gr	Barcode	€
300	330	70	450	486206	13,00

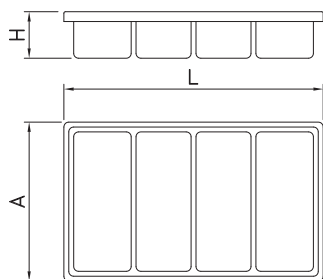

L	A	H	Gr	Barcode	€
530	325	95	335	486208	13,50

Cubertero plástico gris GN 1/1

Cutlery rack GN 1/1 - Grey
Range-couverts gris GN 1/1

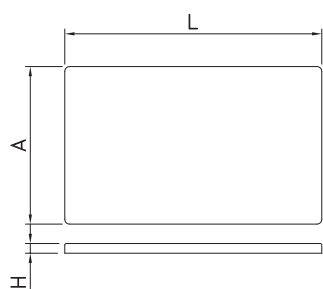

L	A	H	Gr	Barcode	€
530	325	20	100	486210	10,00

Tapa para cubertero plástico gris GN 1/1

Lid for cutlery rack GN 1/1
Couvercle pour Range-couverts gris GN 1/1

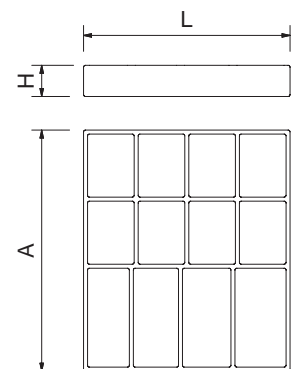

L	A	H	Kg	Barcode	€
311	363	47	0,45	486204	60,00

Separador de monedas y billetes

Coin and bill tray
Plateau à monnaie



Características:

Este portanotas mural, construido en acero inoxidable, mantiene libre la encimera, permitiendo despejar la superficie de trabajo. Nuevos tapones terminales y pack de montaje sin tornillos que asegura una firme fijación.

Characteristics:

This stainless steel notes-holder keeps shelves unobstructed, allowing clear pass-through of orders. New end caps screw securely into place. Now includes mounting pack without screws.

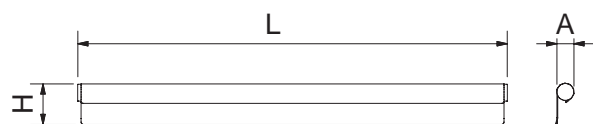

L	A	H	Gr	Barcode	€
508	20	34	400	081802	25,00

Porta-notas mural

Wall mounted note-holder
Porte-notes mural



Caractéristiques:

Cette porte-notes d'acier inoxydable permet agrandir la surface de travail ainsi que la visibilité de la cuisine. Nouveaux bouchons terminaux et pack de montage qui assure une firme fixation sans vis assurer un fort attachement.

Botelleros

Wine racks
Porte-bouteilles



Fabricados en acero inoxidable AISI 304, han sido concebidos como complemento de decoración. Con un diseño de líneas sencillas, estos singulares botelleros se adaptarán a infinidad de espacios, sea cual sea su estilo de decoración.

Wholly constructed of stainless steel AISI 304, they have been thought as a complement in decorating. Thanks to its simple design, this outstanding line of wine racks will fit countless ambiances, whatever the style.



Totalemnt construit en acier inoxydable AISI 304, ils ont été conçus comme un complément en décoration. Grâce à un dessin simple, ce singulier ligne de porte-bouteilles s'adapte à nombreuses ambiances, n'importe quel style décoratif.

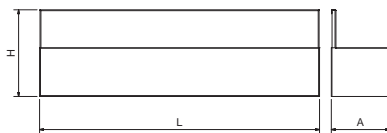
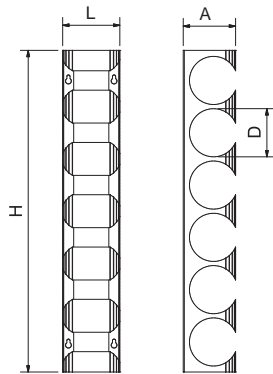

L	A	H	D	Gr	Barcode	€
109	100	615	92		800 083048	45,00
107	85	615	80		800 083050	35,00
575	120	178	108		1.750 083060	65,00

Dispensador de vasos universal

Universal cup dispenser
Distributeur universel de gobelets

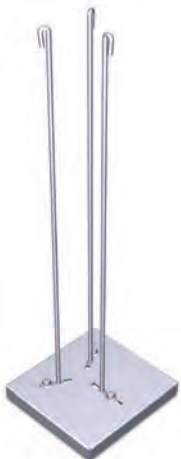

Construido totalmente en acero inoxidable, ideal para exteriores e interiores. Varillas regulables por lo que es válido para distintos tipos de vasos. Diámetro de vaso 30-90 mm.

Totally made in stainless steel. Designed for indoor and outdoor use. Adjustable rods to be adopt any cup dimension. Cup diameter: 30-90 mm.

Construit entièrement en acier inoxydable, idéal pour les extérieurs et les intérieurs. Tiges réglables donc valable pour différents types de gobelets. Diamètre du verre 30-90 mm.

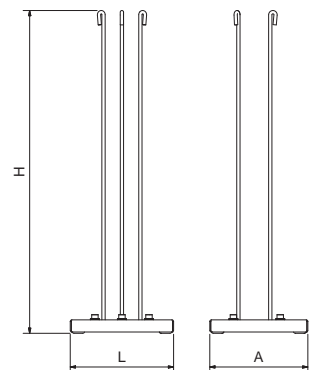

L	A	H	Gr	Barcode	€
158	150	493,5	795	080434	48,00

Novedad
ew
nuevo

Cuelga-copas
Cups rack
Accroche-copas



Con tope trasero para evitar la caída de las copas.

With backstop to prevent the falling of the cups.

Avec arrête buttoir pour empêcher la chute des tasses.



L	A	H	Gr	Barcode	€
470	88	25	575	083002	15,00
970	88	25	1.150	083004	20,00

Cuelga copas en varilla
Rod cups rack
Accroche-copas à tige

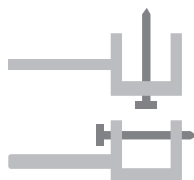
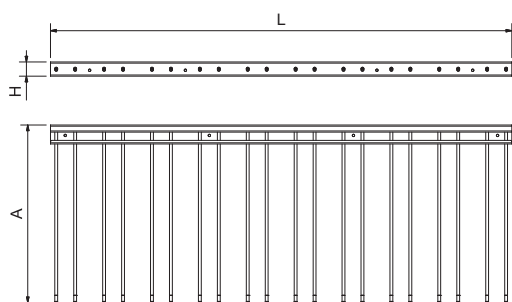
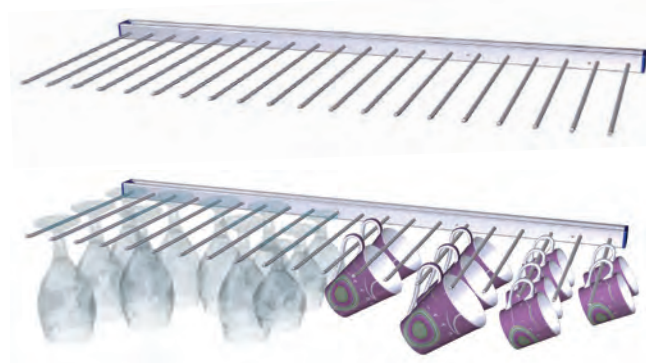

L	A	H	Kg	Barcode	€
973	375	30	3,20	083006	70,00

Dispensador de vasos
Cup dispenser
Distributeur de verres

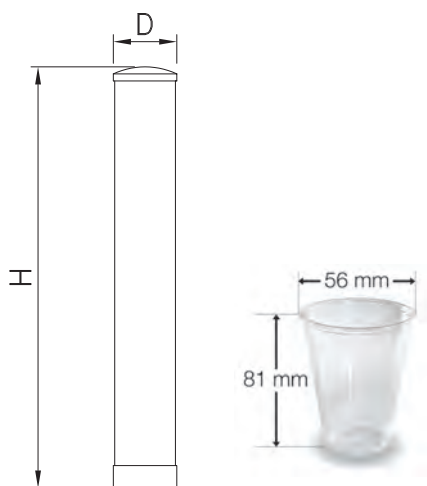

D	H	Gr	Barcode	€
90	597	450	483270	99,00

SopORTE para cafeteras

Stand for coffee pot
Support pour machine à café

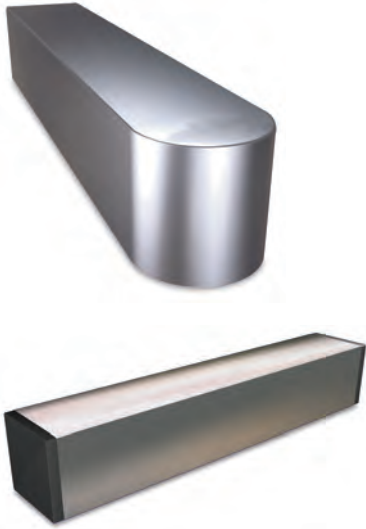

L	A	H	Kg	Barcode	€
---	---	---	----	---------	---

450	80	80	1,3	081202	88,00
-----	----	----	-----	--------	--------------

450	80	80	1,6	081204	38,50
-----	----	----	-----	--------	--------------

Cepillo lavavasos

Glass washer brush
Brosse pour lave-verres



Novedad
ew
ouveau

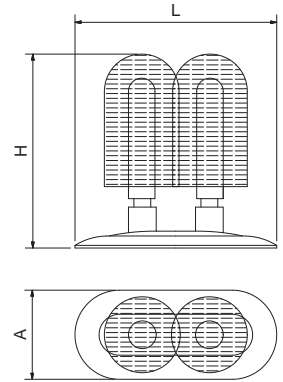

L	A	H	Gr	Barcode	€
---	---	---	----	---------	---

190	100	180	350	483062	21,00
-----	-----	-----	-----	--------	--------------

Escalones para vitrinas

Displays stages
Échelones



Especialmente concebidos para mejorar la exposición de las carnes y embutidos dentro de los mostradores frigoríficos estándar. Su diversidad de medidas facilitan su adaptación a cualquier modelo de expositor. Construidos en chapa de acero inoxidable que, además de garantizar al máximo su duración, es totalmente higiénico y favorece la distribución del frío. Provistos de pies regulables en altura.

Exclusively designed to improve the display of meat and sausage on the stands of standar fridges. Its diversity of sizes make easier the adaptation at any model of stand. Constructed in stainless steel sheet that guarantees the maximum lenght and furthermore favours the cold distribution.

Spécialement conçus pour améliorer l'exposition des viandes et des charcuteries dans les comptoirs frigorifiques standard. Sa diversité de dimensions facilitent sa adaptation a quelque modèle de comptoir. Construit en plaque d'acier inoxydable, laquel en plus de garantir au maximun sa durée, c'est totalement hygiénique et favorise la distribution du froid. Pourvu de pieds réglables en hauteur.

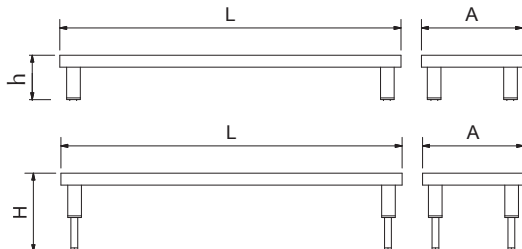

L	A	h	H	Kg	Barcode	€
---	---	---	---	----	---------	---

800	300	130	230	2,8	082002	110,00
-----	-----	-----	-----	-----	--------	---------------

1.000	300	130	230	3,4	082004	115,00
-------	-----	-----	-----	-----	--------	---------------

1.200	300	130	230	3,9	082006	120,00
-------	-----	-----	-----	-----	--------	---------------

1.400	300	130	230	4,4	082008	131,00
-------	-----	-----	-----	-----	--------	---------------

600	400	130	230	2,8	082018	85,00
-----	-----	-----	-----	-----	--------	--------------

800	400	130	230	3,4	082010	120,00
-----	-----	-----	-----	-----	--------	---------------

1.000	400	130	230	4,0	082012	127,00
-------	-----	-----	-----	-----	--------	---------------

1.200	400	130	230	4,7	082014	131,00
-------	-----	-----	-----	-----	--------	---------------

1.400	400	130	230	5,4	082016	146,00
-------	-----	-----	-----	-----	--------	---------------

Soporte sobre-mostrador para balanzas

Stand support for scales
Support sur comptoir pour balances

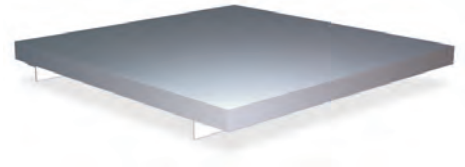

Características:

Específicamente diseñados para colocar las balanzas, cortadoras de fiambre y demás maquinaria encima del mostrador.

Sus topes regulables permiten adaptarse a cualquier ancho de la tapa del mostrador.

Gran firmeza. Fácilmente montable y desmontable.

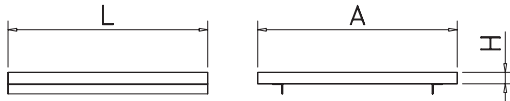

L	A	H	Kg	Barcode	€
390	390	30	3,3	082202	95,00

Characteristics:

Specifically designed for placing scales, sausage cutting and other machines on the stand. Its width adjustable butts allow it to adjust to any width of the stand top. Great firmness. Easy assembly and unassembly.

Caractéristiques:

Espécialement desinés pour placer balances, coupe charcuteries et autres machines sur le comptoir. Ses butoirs réglables en largeur le permettent s'adapter a quelque largeur du couverture sur le comptoir. Gran solidité. Facilité por le monter et démonter.

Tolva evacuación de desperdicios para adosar a tajos de troceo

Waste receptacle for scraps to fix to chopping blocks
Trémie d'évacuation des déchets pour adosser à billots

Válida para ser acoplada en los siguientes modelos de tajos:

Tajos de troceo lastrados.
Tajos de troceo de fibra con faldón.

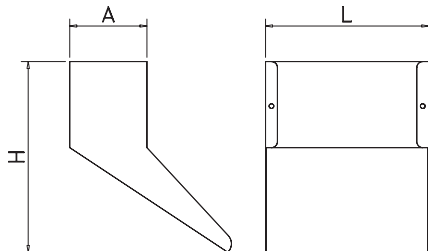

L	A	H	Kg	Barcode	€
275	130	324	2,3	082402	78,00

Valid to be assembled in the following models of chopping blocks:

Reinforced and weighted.
Fibre chopping blocks with fringe.

Valide pour être couplé dans les suivantes modèles d'hachoirs à viande:

Hachoirs à viande blindés.
Hachoirs à viande en fibre avec support à pan.



€	
Tolva acoplada a tajo Receptacle assembled to the chopping block Trémie assemblée dans l'hachoir	90,00

Pala para hielo

Ice spade
Pelle à glaçons

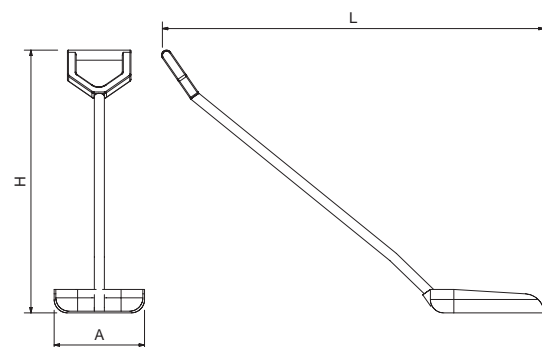

L	A	H	Gr	Barcode	€
890	265	660	500	474458	75,00

Características:

Su fabricación en polipropileno garantiza:
No absorbe agua.
No pierde su dureza en condiciones de humedad.
Puede ser esterilizado (no en autoclave).
Soporta temperaturas de hasta 100°C.

Characteristics:

It is made of polypropylene, which guarantees:
No water absorption.
No loss of hardness in humidity conditions.
Possibility of sterilization.
It resists temperatures up to 100°C.

Caractéristiques:

Sa fabrication en polypropylène garantit:
Pas d'absorption d'eau.
Pas de perte de dureté dans conditions d'humidité.
Possibilité de stérilisation.
Supporte température jusqu'à 100°C.



Pala de mano para hielo

Ice shovel
Pelle à glaçons



Characteristics:

It is made of polypropylene, which guarantees:
No water absorption.
No loss of hardness in humidity conditions.
Possibility of sterilization.
It resists temperatures up to 100°C.

Caractéristiques:

Sa fabrication en polypropylène garantit:
Pas d'absorption d'eau.
Pas de perte de dureté dans conditions d'humidité.
Possibilité de stérilisation.
Supporte température jusqu'à 100°C.

Características:

Su fabricación en polipropileno garantiza:
No absorbe agua.
No pierde su dureza en condiciones de humedad.
Puede ser esterilizado (no en autoclave).
Soporta temperaturas de hasta 100°C.

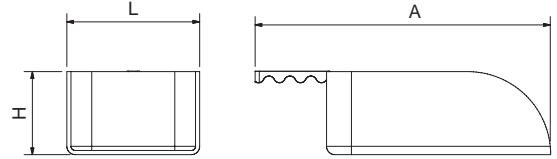

L	A	H	Gr	€
160	340	90	150	474456 18,00

Recubrimiento modular para islas de congelación

Modular lid for island site freezers
Dessus vitré pour congélateurs libre-service



Características:

Sistema modular de cubiertas de vidrio o plástico, diseñado para actualizar las islas de congelados antiguas a las necesidades actuales de ahorro de energía.

Este sistema reduce la transferencia térmica en un 80%.

Perfilería de acero inoxidable.

Fácil de instalar.

Characteristics:

Modular system of glass or plastic lids designed to adapt the old frozen islands to the current needs of energy saving.

This system reduces the heat transfer by 80%.

Sections in stainless steel.

Easy to install.

Caractéristiques:

Système modulaire de dessus vitrés ou en plastique conçus pour adapter les congélateurs libre-service vieux aux besoins actuels d'économie énergétique.

Ce système réduit le transfert thermique le 80%.

Profils en acier inoxydable.

Facile à installer.

	max.	Barcode	€	M. lineal linear meter mètre linéaire
Plástico Plastic Plastique	1.000	083850	250,00	
Cristal Glass Verre	1.000	083802	350,00	

Cubre aperitivos BC

BC appetizers cover
Vitrine à tapas BC

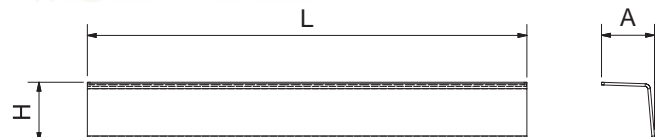
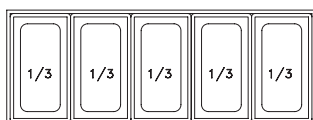
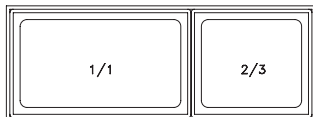
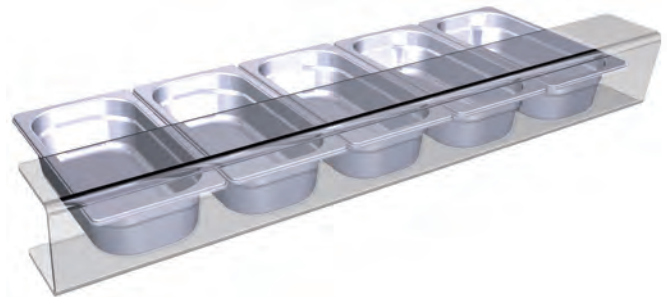

L	A	H	Kg	Barcode	€
1.000	125	135	2,00	083604	65,00

Vitrina cubre aperitivos

Counter top display
Vitrine à tapas



Cubetas GN no incluidas.
GN containers not included.
Bac GN non inclus.

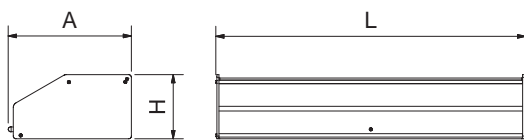

Características:

Capacidad de la vitrina: 5 cubetas
GN 1/3 de 325x176 mm

Characteristics:

Display capacity: 5 containers GN 1/3
(325x176 mm)

Caractéristiques:

Capacité de la vitrine: 5 bacs GN 1/3
(325X176 mm)

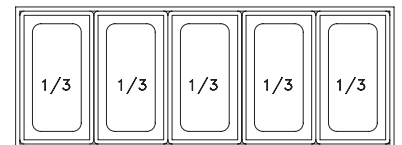
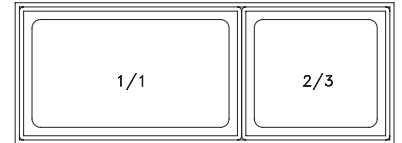

L	A	H	Kg	Barcode	€
918,5	365	190	4,50	083602	170,00

Cubierta basculante para cubetas Gastronorm 1/1

Dome cover for Gastronorm container 1/1
Couvercle basculement pour bac gastro 1/1

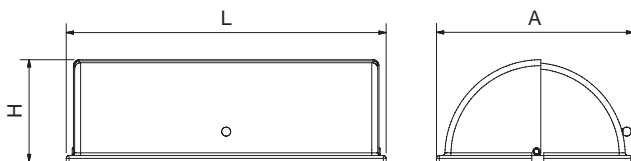

L	A	H	Kg	Barcode	€
530	325	175	1,5	487230	67,00

Vitrina bollería

Pastry showcase
Vitrine viennoiserie

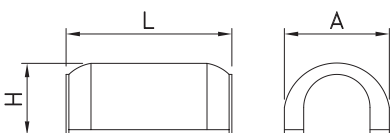

L	A	H	Kg	Barcode	€
450	300	180	1,00	440320	60,00

Vitrina bollería doble piso

Pastry showcase - 2 displaying shelves
Vitrine viennoiserie double étage

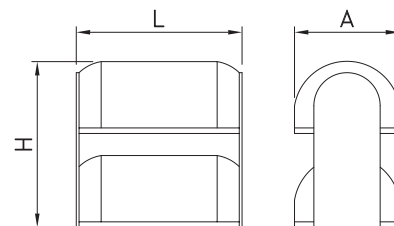

L	A	H	Gr	Barcode	€
300	190	320	800	440318	49,00
400	300	460	1260	440322	138,00

Vitrina expositora

Counter-top store display showcase
Vitrine d'exposition



Novedad
ouveau

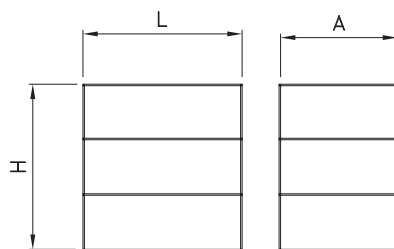

L	A	H	Kg	Barcode	€
430	320	450	4,00	483612	134,00

Gaveta expositora

Pick and mix bin
Casier de rangement



Novedad
ouveau

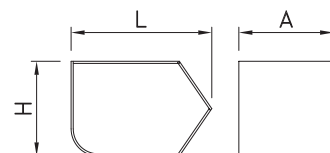

L	A	H	Gr	Barcode	€
260	175	175	600	483610	28,00

Queseras base plástico

Cheese keepers with plastic tray
Cloches à fromage base en plastique

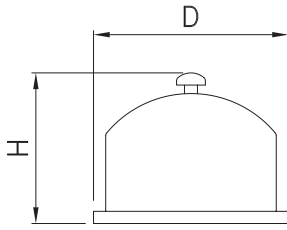

D	H	Gr	Barcode	€
200	150	220	480610	23,00
240	190	250	480612	29,00

Pizarra de led con atril

LED blackboard with easel
Chevalet ardoise lumineuse LED



Rotuladores de tiza borrable no incluido.

Not included erasable chalk marker.

Marquer craie effaçable non inclus.

Características:

Información promocional en escaparates de todo tipo de comercios.
Pizarra para el interior de negocios (bares, hoteles, ...).
Iluminación LED 5050 RGB de alta luminosidad y muy bajo consumo.
Dispone de 90 modos de iluminación seleccionables con el control remoto.
Limpieza fácil y rápida sin rastro del mensaje anterior.

Characteristics:

Promo ads in shop windows.
Blackboard for hotels or catering establishments.
High brightness LED light 5050 RGB, energy saving.
90 selectable different modes of lighting, with remote.
Quick and easy cleaning, without traces of previous ads.

Caractéristiques:

Information promotionnelle dans les vitrines pour quelque boutique.
Ardoise pour intérieur des magasins (bars,hotels...).
Éclairage LED 5050 RGB de haute luminosité et très basse consommation électrique.
90 modes d'éclairage disponibles avec commande à distance.
Facile et rapide nettoyage sans trace du message antérieur.

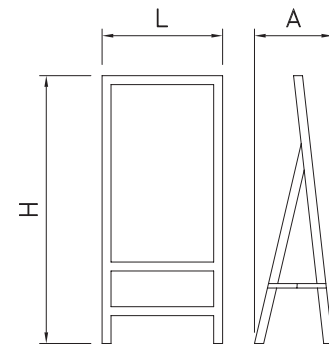

L	A	H	Kg	Barcode	€
540	350	1.200	2,40	480238	128,00

Pizarra de led mural

Wall-mounted LED blackboard
Ardoise lumineuse LED murale



Características:

Información promocional en escaparates de todo tipo de comercios.
Pizarra para el interior de negocios (bares, hoteles, ...).
Iluminación LED 5050 RGB de alta luminosidad y muy bajo consumo.
Dispone de 90 modos de iluminación seleccionables con el control remoto.
Limpieza fácil y rápida sin rastro del mensaje anterior.

Caractéristiques:

Information promotionnelle dans les vitrines pour quelque boutique.
Ardoise pour intérieur des magasins (bars,hotels...).
Éclairage LED 5050 RGB de haute luminosité et très basse consommation électrique.
90 modes d'éclairage disponibles avec commande à distance.
Facile et rapide nettoyage sans trace du message antérieur.

Characteristics:

Promo ads in shop windows.
Blackboard for hotels or catering establishments.
High brightness LED light 5050 RGB, energy saving.
90 selectable different modes of lighting, with remote.
Quick and easy cleaning, without traces of previous ads.

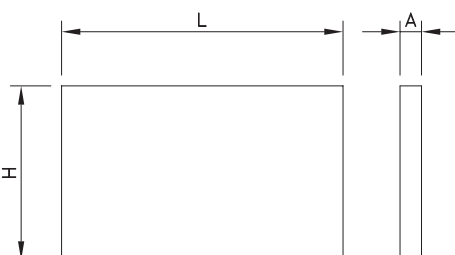

L	A	H	Gr	Barcode	€
600	50	400	500	480236	94,00

Pinzas porta-precios imagine

Price-holder clamp for imagine
Pince à dessin porte-prix pour imagine



↑	Gr	Barcode	€
100	40	413402	3,00
105	40	413404	4,00
150	48	413406	4,75
190	42	413408	4,50
145	38	413410	2,70

Portaprecios en varilla inox con pincho

Inox price-holder rod with spike
Porte-prix en tige inox avec broche



Novedad
ew
ouveau

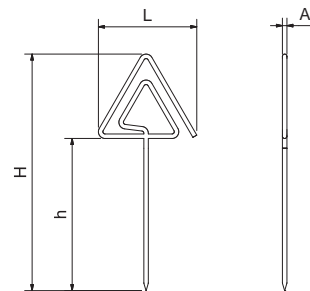

L	A	H	h	Gr	Barcode	€
60	6	160	100	25	081850	5,00

Portaprecios en varilla inox

Inox price-holder rod
Porte-prix en tige inox



Novedad
ew
ouveau

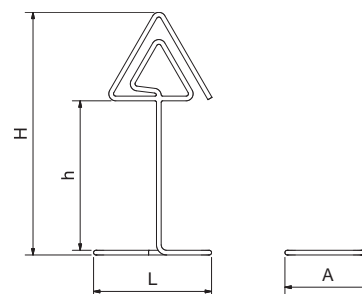

L	A	H	h	Gr	Barcode	€
75	55	165	95	35	081860	10,00

Envasadora al vacío

Vacuum packaging machine
Machine d'emballage sous vide

Características:

Permite envasar al vacío, bolsas y todo tipo de frascos de vidrio con tapa de metal. Cuenta con cuatro modos de funcionamiento diferentes:

- Ciclo automático.
- Manual de succión.
- Ciclo para tarros.
- Ciclo de sellado.

Fabricada con cuerpo de acero inoxidable. Barra de sellado doble (anchura: 3mm) con excelente resistencia al calor. Bandejas extraíbles para facilitar las operaciones de limpieza. Indicador del nivel de vacío.

480260: Largo de sellado: 430 mm, Maxima depresión: 900 mbar, Succión: 32 l/min.

480266: Largo de sellado: 330 mm, Maxima depresión: 800 mbar, Succión: 16 l/min.

Dotación de serie:

480260: 10 bolsas de vacío, 3 bolsas de cocina y 2 válvulas.

480266: 10 bolsas de vacío y 2 válvulas.

L	H	Icon	Gr	Barcode	€
150	300	1.000	500	480280	131,10
200	300	1.000	500	480282	169,95
250	350	500	500	480284	123,75
300	400	500	500	480286	173,10



Caractéristiques:

C'est excellent pour la préservation et l'emballage des aliments, dans toutes sortes de récipients en verre avec un couvercle en métal ainsi comme dans des sacs plastiques. Elle offre quatre modes de fonctionnement différents:

- Cycle automatique
- Mode d'aspiration manuelle
- Cycle de récipients
- Cycle de scellage

Corps en acier inoxydable. Elle est munie d'une barre double d'étanchéité de 3 mm d'épaisseur chacune avec une résistance thermique élevée. Plateau amovible pour faciliter le nettoyage. Indicateur de levier de vide.

480260: Longueur de scellage: 430 mm, Max dépression: 900 mbar, Suction de la pompe double: 32 l/min.

480266: Longueur de scellage: 330 mm, Max dépression: 800 mbar, Suction de la pompe double: 16 l/min.

Équipement et accessoires inclus:

480260: 10 sacs sous vide, 3 sacs de cuisson et 2 valvules.

480266: 10 sacs sous vide et 2 valvules.



Barcode	€	Op
480262	13,00	5

Conjunto de 5 válvulas para máquina de vacío.
Set of 5 valves for vacuum packaging machine.
Set de 5 valvules pour machine d'emballage sous vide.

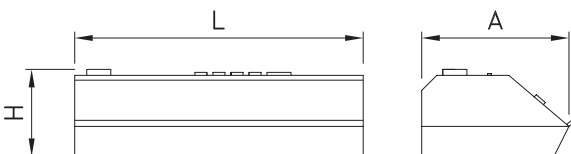

Op Opcional / Optional / Optionnel

L	A	H	Potencia Power Puissance	Tensión Voltage Tension	Frecuencia Frequency Fréquence	Largo de sellado Sealing length Longueur de scellage	Maxima depresión Max depression Max dépression	Succión l/min. Double pump suction Suction de la pompe double	Kg	Barcode	€
480	245	155	600 W	220-240 V	50-60 Hz.	430	900 mbar	32 lt/min.	8,2	480260	795,00
365	185	110	600 W	220-240 V	50-60 Hz.	330	800 mbar	16 lt/min.	3,5	480266	400,00

Envasadora al vacío

Vacuum packaging machine
Machine d'emballage sous vide



L	H		Gr		€
200	300		500	480292	36,00
250	350	100	500	480294	53,00
300	400		500	480296	78,00

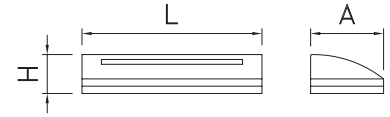

L	A	H	Potencia Power Puissance	Tensión Voltage Tension	Frecuencia Frequency Fréquence	Largo de sellado Sealing length Longueur de scellage	Máxima depresión Max depression Max dépression	Succión l/min. Double pump suction Suction de la pompe double	Kg		€
370	150	80	120 W	220-240 V	50-60 Hz.	300	400/800 mbar	9 lt/min.	1,55	480288	102,00

Envolvedora de sobremesa

Desktop wrapping machine
Machine à envelopper de bureau

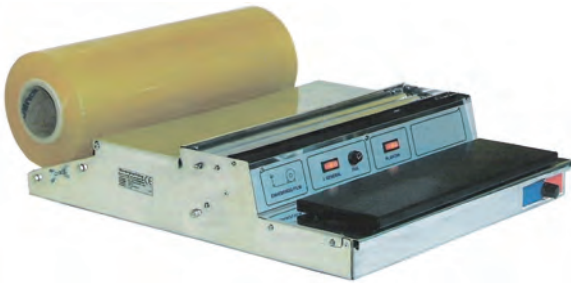

Máquina de envolver de sobremesa para film estirable.

Corte de film por resistencia escamoteable.

Plancha de sellado antiadherente con regulación automática de temperatura.

Indicadores luminosos del estado de la resistencia de corte, sellado y funcionamiento general de la máquina.

Protección contra cargas estáticas.

Sólida fabricación: chapa de acero inoxidable y aluminio anodizado.

APLICACIONES: Aplicable para envolver directamente los productos sobre bandejas de cartón, polietileno, PVC rígido, etc.

FILM UTILIZABLE:

Bobina de film extensible de 450 mm.

Machine d'emballage sur table pour film étirable
Découpage de film par résistance de coupe rétractable.
Plaque d'étanchéité antiadhésive avec contrôle automatique de la température.
Clignotants de l'état de la résistance à la coupure, l'étanchéité et le fonctionnement général de l'appareil.
Protection contre les charges électrostatiques.
Construction solide: tôle d'acier inoxydable et en aluminium anodisé.

APPLICATIONS:

Largement utilisé pour l'emballage des produits directement sur des plateaux en carton, polyéthylène, PVC rigide, etc
MAXIMUM LARGEUR DU FILM 450 MM.

Worktop wrapping machine for stretch film.

Film cut by retractable cutter resistance.

Nonstick sealing hotplate with automatic temperature control.

Indicator lights for the status of the cutting resistance, the sealing and the general operation of the device.

Protection against electrostatic charges.

Solid construction: Stainless steel sheet and anodized aluminum.

APPLICATIONS: Extensively used for packing products directly on consumable trays in carton, polyethylene, rigid PVC, etc.

MAXIMUM FILM: Width 450mm.

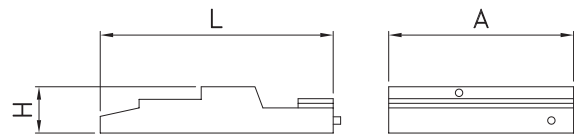

L	A	H	Potencia Power Puissance	Tensión Voltage Tension	Frecuencia Frequency Fréquence	Kg		€
630	500	180	300 W	220-240 V	50-60 Hz.	3,5	480270	343,00

Cierra bolsas inox

Stainless steel bag closer
Scelleuse des sachets en acier inoxydable



Para cinta de 12 mm.

For packing tape 12mm.

Pour du ruban d'emballage 12mm.

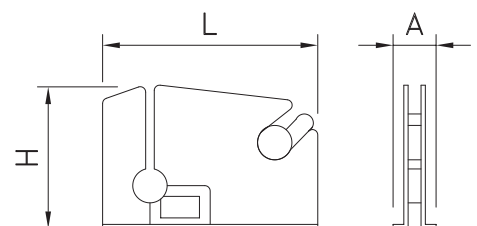

L	A	H	Gr		€
220	75	150	350	480274	24,50

Paragüero inox
Umbrella stand
Porte-parapluies

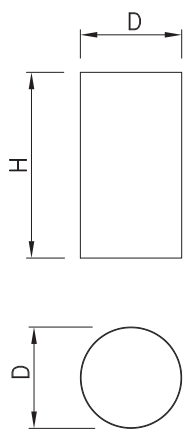

D	H	Kg	Barcode	€
300	550	3,4	481440	75,00



Perchero
Clothes stand
Portemanteau

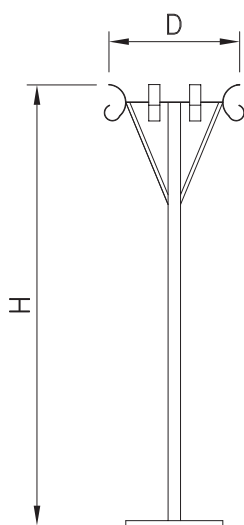

D	H	Kg	Barcode	€
390	1.700	8,0	481444	234,00



Perchero mural de acero inoxidable
Stainless steel wall-mounted rack
Portemanteau mural en acier inoxydable

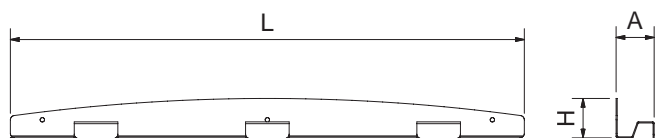

L	A	H	Kg	Barcode	€
708	55	55	0,9	081460	20,00



Percha industrial de acero inoxidable

Stainless steel industrial hanger
Cintre industrielle en acier inoxydable

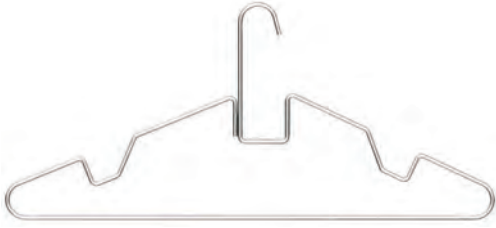

Características:

Totalmente construida en acero inoxidable.
Soldadura de alta resistencia.
Ideal para gimnasios, piscinas, vestuarios colectivos, lavanderías, etc.
Diseño renovado que permite colgar delantales y prendas con tirantes.

Characteristics:

Wholly made in stainless steel.
High resistance welding.
Excellent for gymnasiums, swimming pools, dressing-rooms, laundries, etc.
New design that allows to hang up aprons and garments with shoulder straps.

Caractéristiques:

Entièrement construit en acier inoxydable.
Soudure en haute résistance.
Excellente pour gymnases, piscines, établissements de bains, blanchisseries, etc.
Dessin renouvelé qui permet prendre des tabliers et vêtements à épaulettes.

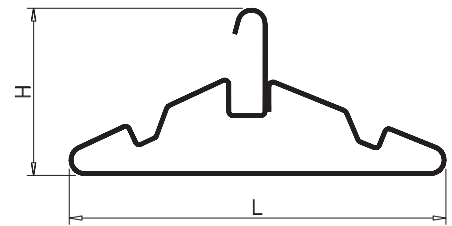

L	H	Gr	081450	€
420	190	120	081450	10,00

Set colgador sujeta-palos

Handle-holder kit
Kit porte-manches



L	A	H	Gr	481208	€
330	85	55	320	481208	45,00

Pictogramas en acero inoxidable

Stainless steel pictograms
Pictogrammes en acier inoxydable

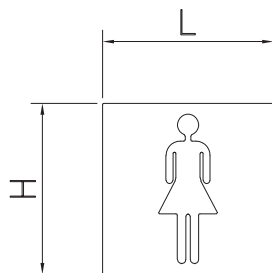

Novedad
ew
nouveau

Novedad
ew
nouveau

	L	H	Gr	Barcode	€	
	Aseo Mujer Women restroom Toilette femme	120	120	175	082604	12,50
	Aseo Hombre Men restroom Toilette homme	120	120	175	082602	12,50
	Aseo familiar Family toilet Toilette familial	120	120	175	082618	12,50
	Cambia-Bebes Baby changing room Chambre bébés	120	120	175	082616	12,50
	Tercera edad Senior people Personnes âgées	120	120	150	082666	12,50
	Aseo unisex Unisex toilet Toilette unisexe	120	120	175	082634	12,50
	Aseo Discapacitados Disabled restroom Toilette handicapés	120	120	175	082614	12,50
	Ascensor Lift Ascenseur	120	120	139	082668	12,50
	Vestuario/Guardarropa Dressing room or cloakroom Vestiaire ou garde-robe	120	120	175	082620	12,50
	Duchas Shower Douche	120	120	175	082636	14,00
	Botiquín First aid box Boîte de secours	120	120	175	082628	12,50

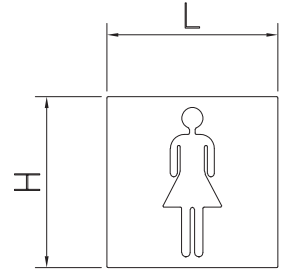

	L	H	Gr	Barcode	€
	120	120	175	082630	12,50
	120	120	175	082626	12,50
	120	120	175	082612	12,50
	120	120	175	082608	12,50
	120	120	175	082606	12,50
	120	120	175	082610	12,50
	120	120	175	082622	14,00
	120	120	175	082624	14,00
	120	120	175	082632	13,50
	120	120	175	082638	12,50
	120	120	175	082640	12,50
	120	120	175	082642	12,50

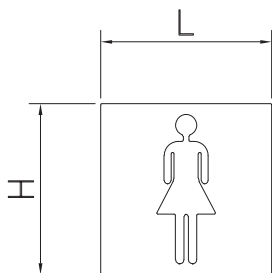













Solicite **GRATIS**
el expositor de
pictogramas

Ask for free our
cardboard stand of
pictograms

Demandez le
présentoir de
pictogrammes
gratuit



	L	H	Gr	Barcode	€
 Carros Shopping carts Caddies	120	120	175	082644	14,00
 WC WC WC	120	120	175	082664	12,50
 Número 0 Number 0 Numéro 0	60	120	70	082646	12,00
 Número 1 Number 1 Numéro 1	60	120	70	082648	12,00
 Número 2 Number 2 Numéro 2	60	120	70	082650	12,00
 Número 3 Number 3 Numéro 3	60	120	70	082652	12,00
 Número 4 Number 4 Numéro 4	60	120	70	082654	12,00
 Número 5 Number 5 Numéro 5	60	120	70	082656	12,00
 Número 6 Number 6 Numéro 6	60	120	70	082658	12,00
 Número 7 Number 7 Numéro 7	60	120	70	082660	12,00
 Número 8 Number 8 Numéro 8	60	120	70	082662	12,00
 Número 9 Number 9 Numéro 9	60	120	70	082658	12,00

Columna señalización con cinta

Belt barrier post
Colonne de signalisation avec bande



Características:
Metal cromado.
Cinta azul de 2,7 metros.

Characteristics:
Chromed-plated metal.
2.7 meter blue ribbon.

Caractéristiques:
Métal Chromé.
Ruban bleu de 2,7mètres.

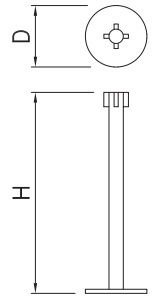

D	H	Kg	Barcode	€
70	980	8,5	481446	204,00

Visor su turno con mando

Queuing ticket screen with remote controlled
Écran pour file d'attente avec commandé

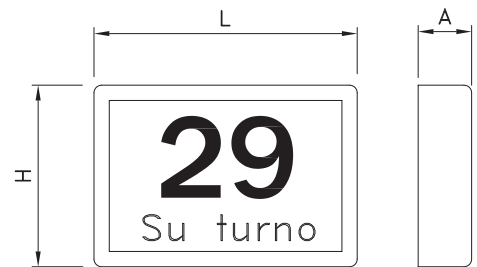

L	A	H	Potencia Power Puissance	Tensión Voltage Tension	Frecuencia Frequency Fréquence	Kg	Barcode	€
345	60	238	6 W	220-240 V	50-60 Hz.	4,50	480811	265,00

Dispensador de tickets su turno

Queuing ticket dispenser
Distributeur de tickets file d'attente



480809 € Op 4,00

Rollo 2.000 tickets su-turno
Roll of 2000 queue tickets "My turn"
Rouleau de 2000 tickets pour file d'attente

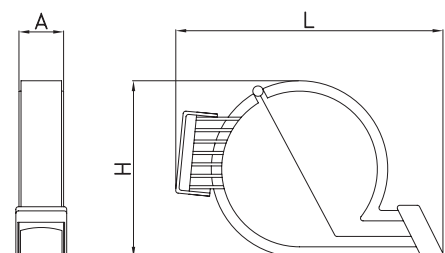
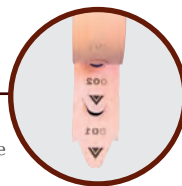

L	A	H	Kg	Barcode	€
265	45	175	0,32	480810	20,00

Columna de acero inoxidable para dispensadores

Stainless-steel stand for dispensers
Stand en acier inoxydable pour distributeurs

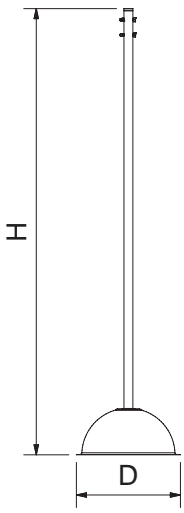

D	H	Kg	Barcode	€
290	1.245	9,00	080430	110,00

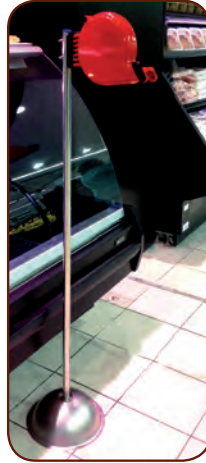

Columna inoxidable con dispensador "Su turno"

Stainless floor stand for queuing ticket dispenser
Pied inoxydable avec distributeur "votre Tour"

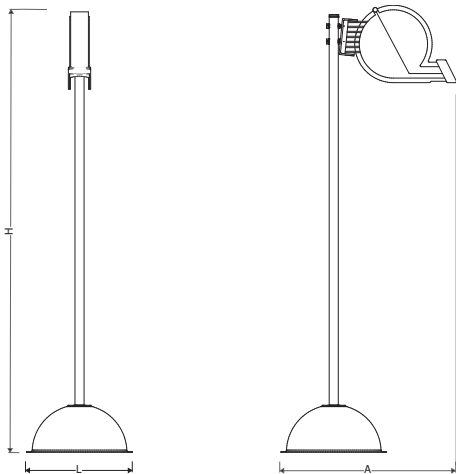

L	A	H	Kg	Barcode	€
290	422	1.245	9,32	080432	145,00



Equilibrador

Spring balancer
Équilibrateur

Características:

Equilibrador para uso intermitente.
Capacidad regulable y dispositivo de limitación de carrera.
Cuerpo de chapa metálica.
Longitud del cable: 1000 mm.
Capacidad de 0,5 - 1,5 kilos.

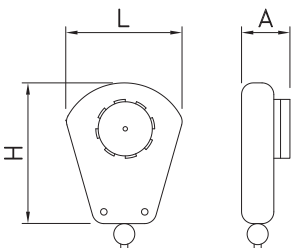

Characteristics:

Spring balancer for intermittent use.
Adjustable capacity with stroke limitation device.
Metallic sheet body.
Cable length: 1000 mm.
Capacity from 0,5 - 1,5 kg

Caractéristiques:

Équilibrateur pour usage intermittent.
Capacité réglable et dispositif de limitation de vitesse.
Boîtier en tôle métallique.
Longueur du câble : 1000 mm
Capacité de 0,5-1,5 Kg

L	A	H	Gr	Barcode	€
100	55	120	500	463030	66,00



Taburete inox

Stainless steel stool
Tabouret inoxydable

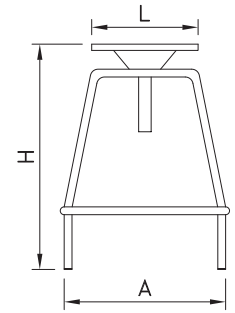

L	A	H _{total}	H _{seat}	Kg	Barcode	€
350	510	850	700	4,0	482206	270,00

Escalones inox

Inox stairs
Marche inox

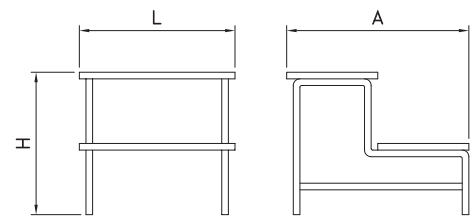

L	A	H	Kg	Barcode	€
470	550	430	1.50	482208	180,00

Taburete con ruedas

Rolling step-stool
Tabouret marche - pied roulant



Características:

Este taburete metálico lleva en su base tres ruedas que permiten su fácil traslado de un sitio a otro con un simple empujón del pie, sin embargo en el momento en que usted sube sobre él queda totalmente fijado al suelo gracias a su burlete circular que se adhiere como una ventosa.

Disponible en otros colores, a partir de 24 unidades.



482250 €
5,80

Rueda de repuesto para taburetes.
Spare wheel for step-stools.
Rouelle de rechange pour tabouretes.

Characteristics:

This metallic stool has on its base three castors that allow moving it from one place to another easily, just pushing it with your foot. Furthermore, whenever you are standing on it, it is firmly fixed to the floor, as if it were a suction pad, thanks to its rounded rubber strip.

Available in other colors. From 24 units.

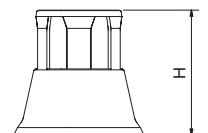

Caractéristiques:

Ce tabouret métallique a dans sa base trois rouelles qui permettent le déplacer facilement de long en large, avec un seul poussé du pied. En plus, lorsqu'on monte sur lui, il reste totalement fixé au sol, comme une ventouse, grâce à sa bande ronde en caoutchouc.

Disponible dans d'autres couleurs. A partir de 24 unités.

D	H	Kg	Barcode	€
			482202	
430	430	4,6	482204	55,00
			482210	

Losetas antideslizantes
Non-slip floor sleds
Caillebotis anti-dérapant

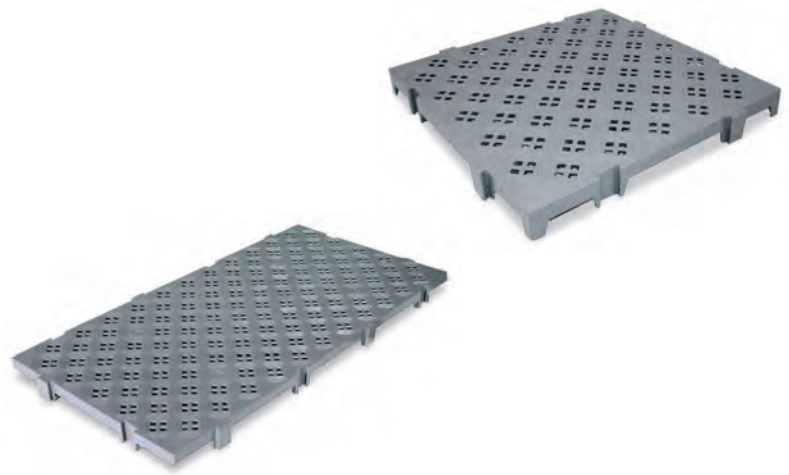
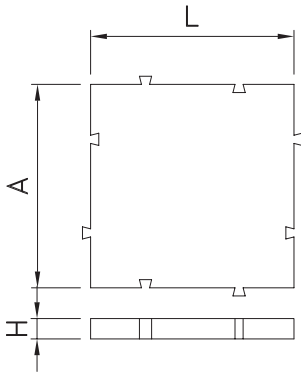

L	A	H	Kg	Barcode	€
500	500	25	1,10	481040	14,00
500	500	50	1,73	481042	20,00
1.000	500	50	3,35	481044	41,00

Rampa loseta
Floor slat ramp
Rampe pour caillebotis

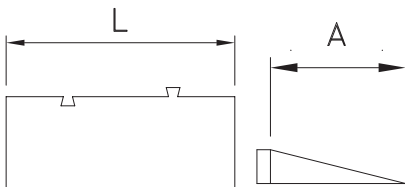

L	A	H	Gr	Barcode	€
500	200	50	565	481046	19,00

Europalet encajable liso
Stackable closed deck europallet
Euro palette emboitable à plateau plein

Características:
Superficie de apoyo: 9 patas.
Material: HDPE.

Characteristics:
Support points: 9 legs.
Material: HDPE.

Caractéristiques:
Surface d'appui: 9 plots.
Matériel: HDPE.

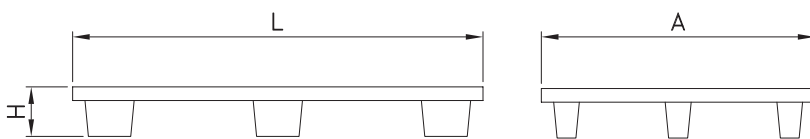

L	A	H	Kg	Carga		Kg	Barcode	€
				dinámica Dynamic load Charge dynamique	estática Static load Charge statique			
1.200	800	145	850	3.400	7,80	481020	39,00	

Tapa para Europalet encajable liso
Cover for stackable closed deck europallet
Couvercle pour Euro palette emboitable à plateau plein



Válido para palets encajables lisos 481020.
Valid for stackable closed deck pallets 481020
Valide pour palettes emboitable a plateau plein 481020

Gr	Barcode	€
4,50	481022	2,50

Europalet higiénico reforzado

Heavy duty hygienic Euro pallet
Euro palette hygiénique renforcé

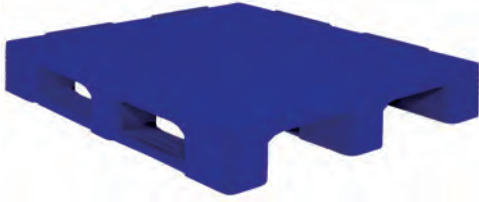

Características:

Superficie superior e inferior completamente lisa para una fácil limpieza.

Rebordes perimetrales antideslizantes.

Material: Polietileno de alta densidad en calidad alimentaria.

Posibilidad de insertar un chip.

Characteristics:

Upper and lower deck completely sealed for hygiene.

Non-slipping raised edges.

Material: High density polyethylene for food industry.

Possibility of integrating micro-chip.

Caractéristiques:

Plateaux supérieur et inférieur complètement lisses pour nettoyage aisé.

Rebords anti-glisement.

Matériau: polyéthylène haute densité pour l'industrie alimentaire.

Possibilité d'intégrer une puce.

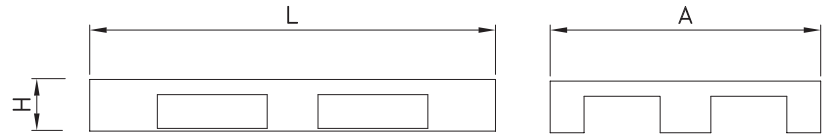

			Carga dinámica Dynamic load Charge dynamique	Carga estática Static load Charge statique			
L	A	H	Kg.	Kg.			€
1.200	800	153	1.500	7.500	18,0	481002	155,00

Transpaleta de acero inoxidable

Stainless steel pallet truck
Transpalette en acier inoxydable



Características:

Capacidad: 2000 kilos.

Todas las piezas están hechas de acero incluyendo bomba hidráulica, marco tenedor, manija, barra de empuje, teniendo, pasador y tornillo, etc.

Para su uso en la carne y otros de la industria alimentaria, conservera de productos lácteos y todas las áreas donde se utilizan ácidos corrosivos y soluciones salinas.

Rodillos / ruedas: Nylon.

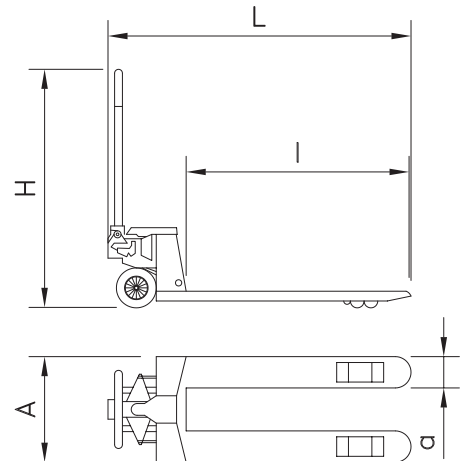

Characteristics:

Capacity: 2000 kg

All its parts are made in stainless steel, included the hydraulic pump, the fork frame, the handle, the pulling bar, the dowel and the screw, etc.

Specially for dairy, canning and meat industries and for food industry in general. Recommended for usage with corrosive acids and saline solutions.

Rollers / wheels: nylon.

Caractéristiques:

Capacité : 2000 kg

Toutes les pièces sont en acier y compris pompe hydraulique, cadre, manette, barre de poussée, verrou, vis. Etc.

Usage pour la viande et autre industrie alimentaire, industrie laitière et dans les domaines où l'on utilise des acides corrosifs et solutions salines.

Rouleaux/roulettes nylon.

L	A	H	I	a	Kg		€
1.550	540	1.220	1.150	160	75,00	480228	3.754,00

Transpaleta pintada

Pallet truck in painted steel
Transpalette peinte

Características:

Capacidad: 2000 kilos.

Sistema incorporado en la válvula de sobrecarga y totalmente sellado de la bomba hidráulica.

Kit de sellado alemana ofrece larga vida útil de la bomba durante 3 años de garantía.

Servicio pesado y horquillas reforzadas para mayor resistencia y durabilidad.

Rodillos de entrada y salida 2 de nylon evitan el esfuerzo físico del operador y protegen los rodillos de carga y palet.

Bujes sin aceite en los puntos clave que ofrecen una menor fuerza de accionamiento y la duración de la vida más larga de transpaleta.

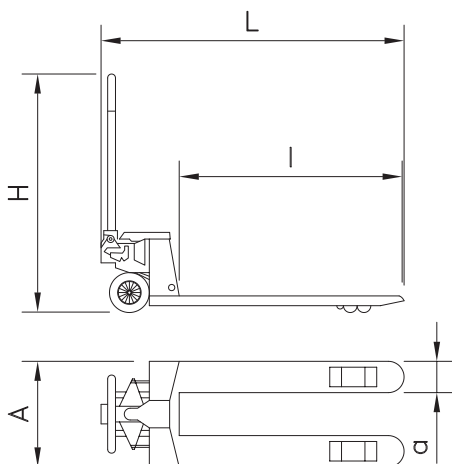

L	A	H	I	a	Kg	480229	€
1.550	540	1.220	1.150	160	78,00	480229	635,00



Characteristics:

Capacity: 2000 kg

Overload valve and sealed hydraulic pump for a long-life. 3 years of warranty.

Heavy duty: reinforced fork for strenght and durability. 2 feed and run-out rollers in nylon to reduce the operator fatigue and to protect the rolls. Oil-free bushings in critical points for a lesser effort during operation and to prolong the life of the pallet truck.

Caractéristiques:

Capacité : 2000 kg

Système incorporé dans la valve de sécurité et totalement scellé de la pompe hydraulique.

Kit de scellage allemand offre une durée de vie utile longue de la pompe durant 3 ans de garantie.

Fourches renforcées pour une meilleure résistance et durabilité.

Rouleaux d'entrée et sortie en nylon qui évitent l'effort de l'utilisateur et protègent les rouleaux de charge et palette.

Moyeux sans huile qui garantissent une manoeuvre plus facile avec moins d'effort et durée de vie plus longue de la transpalette.

Plataforma rodante

Rolling platform
Plate-forme roulante



Características:

4 ruedas giratorias de poliamida con banda de goma y horquillas de poliamida.

Carga max. 250 kgrs.

Material: ABS.

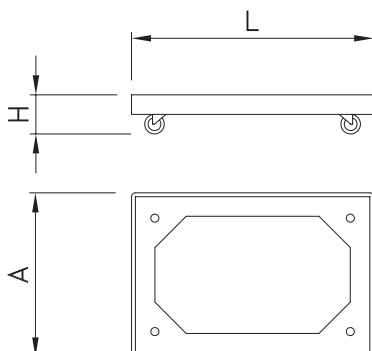

Characteristics:

4 castors in polyamide with rubber band and polyamide fork.

Max. 250 kg.

Material ABS.

Caractéristiques:

4 roulettes en polyamide avec bande en caoutchouc et fourche en polyamide.

Max. 250 kg. Matière ABS.



***HASTA 250 Kg**
Up to 250 kgs of load strength
Jusqu'à 250 kgs de résistance

L	A	H	Kg	481060	€
620	420	100	3,60	481060	63,00

Plataforma con freno para transporte de cestos de lavavajillas

Cart for racks with break
Plate-forme pour transport de paniers de lave-vaisselle



Novedad
ew
ovesta

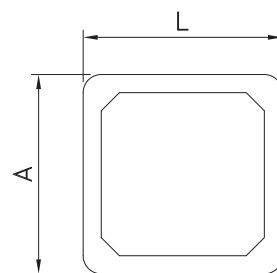

L	A	Kg	Barcode	€
550	550	2,65	483016	106,00

Carro para transporte de barriles

Trolley for drums and barrels
Chariot pour transport de barils

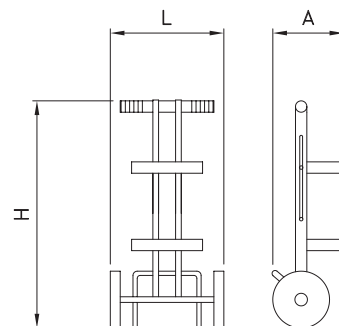

L	A	H	Kg	Barcode	€
400	250	800	3,5	480226	200,00

Cutter con cierre seguridad (Metal detectable)

Metal detectable safety cutter knife
Cutter de sécurité avec métal détectable



481252



15,00



10



Juego de cuchillas de repuesto.
Spare scraper blades.
Jeu de lames de réchange.

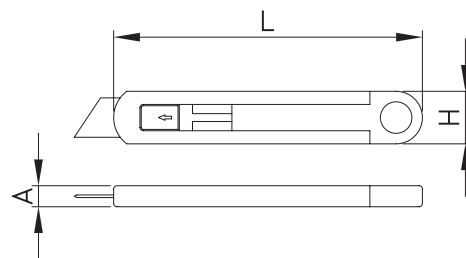
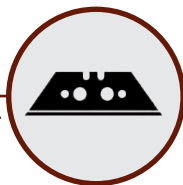

L	A	H	Gr	Barcode	€
142	15	30	90	481250	24,00

Cutter combi (Metal detectable)

Combi cutter knife Metal detectable
Cutter avec métal détectable combi

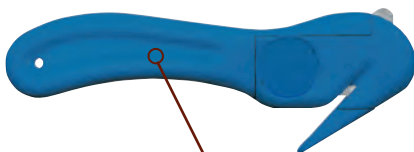

481256



11,00



10



Juego de cuchillas de repuesto.
Spare scraper blades.
Jeu de lames de réchange.

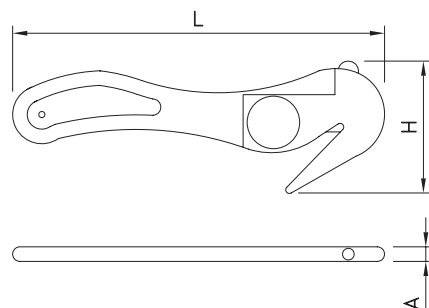
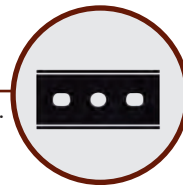

L	A	H	Gr	Barcode	€
150	7	50	58	481254	19,00

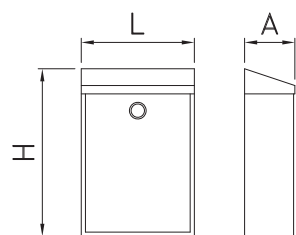

L	A	H	Kg	Barcode	€
270	50	400	1,90	481822	83,00

Buzón inoxidable

Stainless steel mailbox
Boîte aux lettres inoxydable

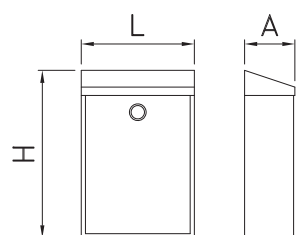

L	A	H	Kg	Barcode	€
370	120	370	3,50	481824	91,00

Buzón inoxidable Plus

Stainless steel mailbox Plus
Der rostfreie Plus Briefkasten

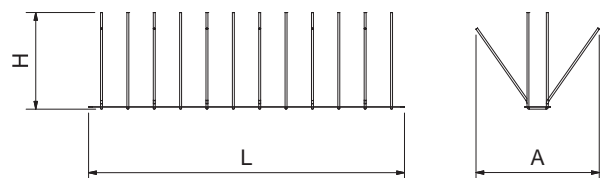

L	A	H	Gr	Barcode	€
490	191	150	350	084602	18,00

Pincho antipalomas en acero inoxidable

Stainless steel deterrent spikes for pigeons
Tige anti-pigeons en acier inoxydable

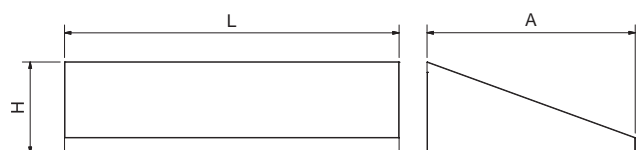
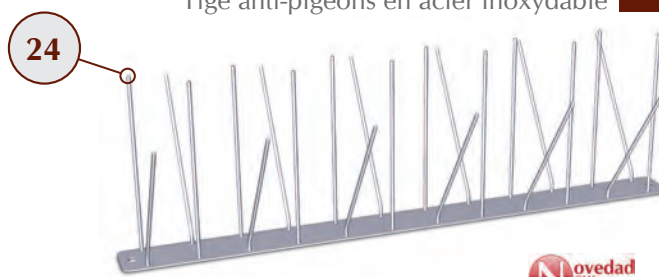

L	A	H	Kg	Barcode	€
1.270	347	790	10,88	083270	300,00

Marquesina para puertas

Canopy for doors
Auvent pour portes

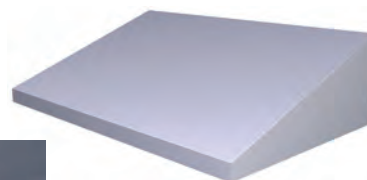

Cortina de lamas de PVC

PVC strip curtain
Ride aux à lanières en PVC

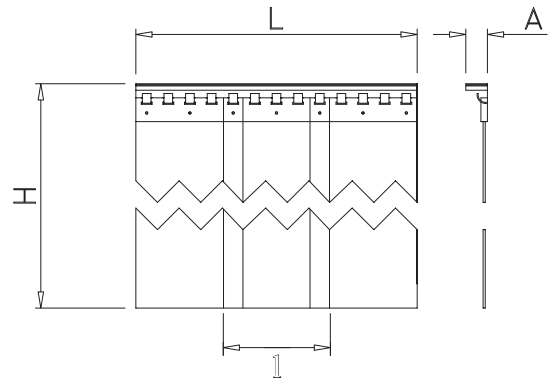

L	A	H	I	Kg	Barcode	€
984	40	2.000	200	1,35	082460	299,00

Consigna para carros con taquilla

Left-trolleys with locker
Consigne pour caddies avec casier

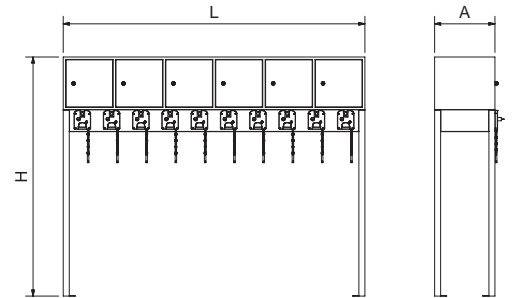

L	A	H	I	Kg	Barcode	€
2.000	400	1.590	10	40	081432	1.200,00

Consigna para carros

Left-shopping trolleys
Consigne pour caddies

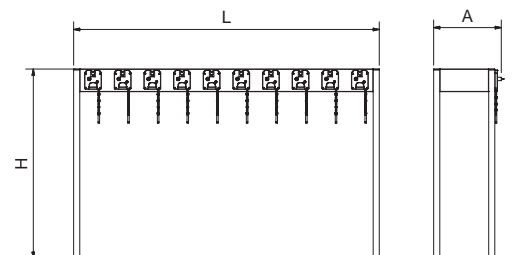
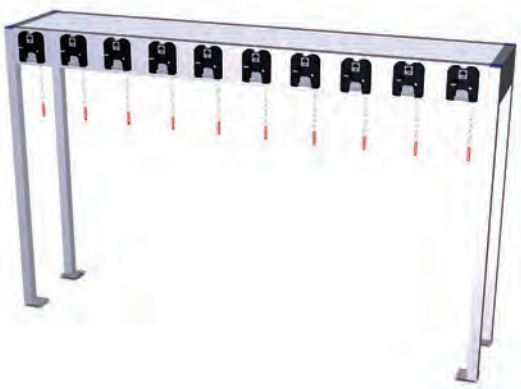

L	A	H	I	Kg	Barcode	€
2.000	400	1.240	10	24	081430	725,00

Consigna mural para carros

Wall left-shopping trolleys
Consigne mural pour caddies

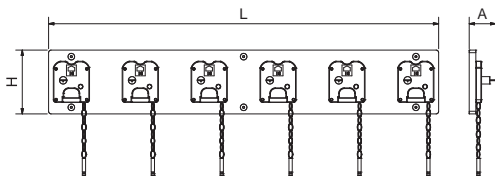

L	A	H				€
1.185	81	194	6	8	081434	459,00

Taquilla - Consigna

Left-shopping - Lockers
Casiers - Consigne

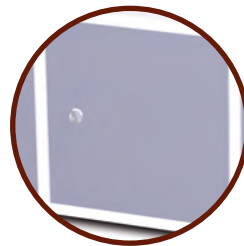
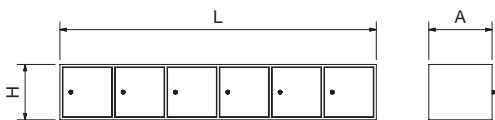

L	A	H			€
2.000	400	350	16	481436	635,00

Repuestos y complementos

Spare part and complements
Rechange et compléments



Cerradura
Lock
Serrure

Gr €

41 481404 5,00



Cerradura maestra
Master lock
Serrure master

481405 8,00



Llave maestra para cerraduras
Master key for locks
Clé passe-partout pour serrures

10 481402 3,00



Cerradura de retorno de monedas
Coin operated lock
Serrure à monnaies











790 481410 50,00
 481412

Montaje de la cerradura de retorno de monedas (no incluye cerradura)
Assembly coin operated lock (lock not included in this price)
Assembler serrure à monnaies (serrure n'inclus pas dans ce prix)

081452 30,00

Repuestos y complementos

Spare part and complements
Rechange et compléments

		Gr	Barcode	€
	Pomo articulado Articulated handle Poignée articulée	80	481406	5,50
	Candado para pomo articulado Padlock for articulated handle Cadenas poignée articulée	105	481408	22,00
	Juego de herrajes para puertas (para 2 puertas) Sliding doors fixtures set (valid for two doors) Set de ferrures pour portes coulissantes (valide pour deux portes)	85	073850	63,00
	Taco regulable Adjustable blocks Taquets réglables	45	409851	1,34
	Taco regulable altura especial Special height adjustable blocks Taquets réglables hayteur spéciale	115	409848	2,75
	Tirador para puerta abatible Handle for hinged door Poignet pour porte battante	80	474050	6,00
	Cierre de clip de bolas Roller bracket closing Fermeture à rouleau	40	474052	4,50
	Juego de llaveros numerados del 1 al 6 Set of keyrings, numbered from 1 to 6 Ensemble de porte-cl-es numérotés de 1 à 6	30	481438	9,00
	Juego de placas numeradas del 1 al 6 Set of plates, numbered from 1 to 6 Ensemble de plaques numérotées de 1 à 6	20	481439	6,50
	Cerradura con cadena para consigna de carros Locker with chain for left-shopping trolleys Serrure avec chaîne pour consigne pour caddies	850	481430	63,00
	Cerradura electrónica para taquilla Electronic lock for lockers Serrure électronique pour la porte vestiaire	584	→ 481418	77,00
			← 481419	
	Montaje cerradura electrónica en puerta de taquilla (no incluye cerradura) Installation of electronic lock for lockers (lock not included) Montage serrure électronique sur porte de vestiaire (la serrure n'est pas incluse)		081454	30,00

Cenicero con soporte y depósito de arena

Ashtray with support and tray for sand
Cendrier avec support et plateau pour sable



Características:

Cenicero de gran resistencia en acero inoxidable.
Dispone de un depósito para llenarse con arena u otra sustancia inerte no inflamable para facilitar el apagado de los cigarrillos.

Characteristics:

Stainless steel heavy duty.
Provided with a tray to be filled with sand or another not inflammable substance to make easier the extinguishing of cigarettes.

Caractéristiques:

Cendrier à haute résistance en acier inoxydable.
C'est pourvu avec un plateau pour le remplir avec sable ou autre substance inerte non inflammable pour faciliter l'éteint des cigarettes.

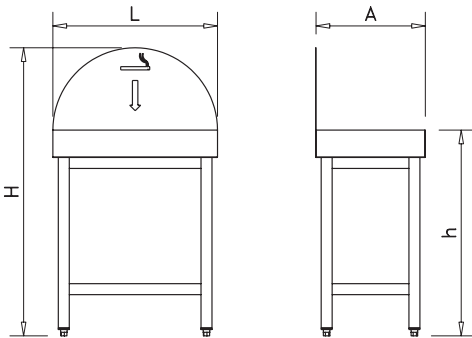

Recomendado para:

Hoteles
Restaurantes
Lugares de trabajo
Bares
Edificios públicos en general
Aparcamientos

Recommended for:

Hotels
Restaurants
Workplaces
Bars
Public places in general
Parkings

Recommandé pour:

Hôtels
Restaurants
Locaux de travail
Bares
Locaux publics en général
Parkings

L	A	h	H	Kg	080650	€
600	400	750	1.050	16,6	080650	475,00

Cenicero papelera

Ashtray - wastepaper bin
Cendrier - poubelle inox



Características:

Dos usos en un mismo espacio.
Totalmente fabricada en acero inoxidable, está diseñada para usarla en exteriores.
Incorpora recipiente GN 1/3 de profundidad 65 mm.
Desmontable para su vaciado y limpieza. Posibilidad de lavado a máquina.
Papelera provista de anillas para una mejor y más cómoda colocación de sacos y bolsas.

Characteristics:

Double use within the same space.
Wholly made of stainless steel, it has been thought for external use.
With a container GN 1/3 - 65 mm. depth
Detachable for emptying and cleaning. It can be washed in the dish washer.
Wastepaper provided of rings to put the bags inside easily.

Caractéristiques:

Deux utilisations, même espace.
Entièrement en acier inoxydable. Il est possible son utilisation à l'extérieur.
Avec un récipient GN 1/3 - 65 mm profondeur.
Détachable pour la vidange et le nettoyage. Il peut être lavé dans le lave-vaisselle.
Corbeille à papier munie des anneaux pour mettre les sacs à l'intérieur facilement.

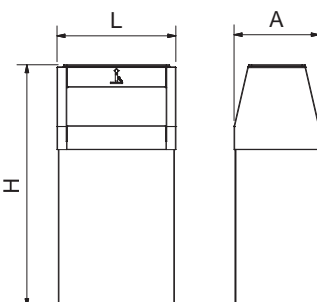

L	A	H	lit	Kg	080658	€
360	258	733	44 lts	6,5	080658	288,00

Caperuza porta-cenicero para papelera

Balanced swing top with ashtray for waste bin
Couvercle inox basculant avec cendrier pour poubelle



Características:

Convierte la papelera basculante en un cenicero-papelera. Dos usos en un mismo espacio.
Totalmente fabricada en acero inoxidable, está diseñada para usarla en exteriores.
Incorpora recipiente GN 1/3 de profundidad 65 mm.
Desmontable para su vaciado y limpieza. Posibilidad de lavado a máquina.

Characteristics:

Transformez votre poubelle basculante en une poubelle cendrier. Deux utilisations, même espace.
Entièrement en acier inoxydable. Il est possible son utilisation à l'extérieur.
Avec un récipient GN 1 / 3 - 65 mm profondeur
Détachable pour la vidange et le nettoyage. Il peut être lavé dans le lave-vaisselle.

Caractéristiques:

Turn your swing waste bin into a waste bin-ashtray. Double use within the same space.
Wholly made of stainless steel, it has been thought for external use.
With a container GN 1/3 - 65 mm. depth
Detachable for emptying and cleaning. It can be washed in the dish washer.

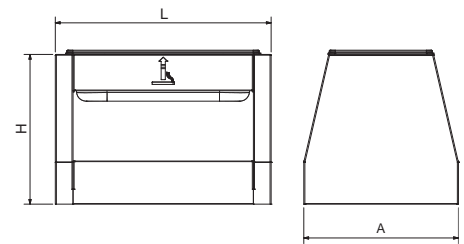

L	A	H	Kg	Barcode	€
360	258	260	1,9	080659	154,00

Cenicero para espacios reducidos de pie

Floor-mounted ashtray for reduced spaces
Cendrier inox pour espaces réduits sur pied

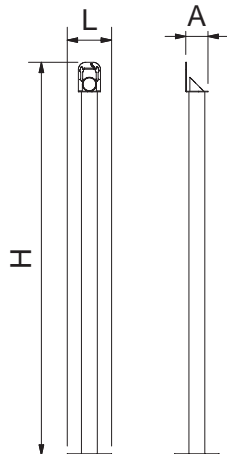

Características:

Construido totalmente en acero inoxidable. Su diseño permite ocupar el mínimo espacio en el interior o exterior de su negocio.
Diseñado para colocarse en cualquier rincón, incluso detrás de una puerta.
Depósito de agua interior para el mejor apagado de los cigarrillos.
Desmontable para su vaciado y limpieza. Posibilidad de lavado a máquina.

Characteristics:

Wholly made of stainless steel, it has been thought to occupy little space both in indoor and outdoor areas.
It can be installed anywhere in your shop, even behind the door.
Inner water tank to put out cigarettes easily.
Detachable for emptying and cleaning. It can be washed in the dish washer.

Caractéristiques:

Entièrement en acier inoxydable, il a été conçu pour occuper peu de place à l'extérieur et à l'intérieur.
Il peut être installé n'importe où dans votre magasin, même derrière la porte.
Réservoir d'eau intérieur pour éteindre les cigarettes facilement.
Détachable pour la vidange et le nettoyage. Il peut être lavé dans le lave-vaisselle.

L	A	H	Kg	Barcode	€
120	60	1.064	2,3	080654	125,00

Cenicero para espacios reducidos

Ashtray for reduced spaces
Cendrier inox pour espaces réduits

Características:

Construido totalmente en acero inoxidable. Su diseño permite ocupar el mínimo espacio en el interior o exterior de su negocio.

Diseñado para colocarse en cualquier rincón, incluso detrás de una puerta.

Depósito de agua interior para el mejor apagado de los cigarrillos.

Desmontable para su vaciado y limpieza. Posibilidad de lavado a máquina.

Characteristics:

Wholly made of stainless steel, it has been thought to occupy little space both in indoor and outdoor areas.

It can be installed anywhere in your shop, even behind the door.

Inner water tank to put out cigarettes easily.

Detachable for emptying and cleaning. It can be washed in the dish washer.

Caractéristiques:

Entièrement en acier inoxydable, il a été conçu pour occuper peu de place à l'extérieur et à l'intérieur.

Il peut être installé n'importe où dans votre magasin, même derrière la porte.

Réservoir d'eau intérieur pour éteindre les cigarettes facilement.

Détachable pour la vidange et le nettoyage. Il peut être lavé dans le lave-vaisselle.

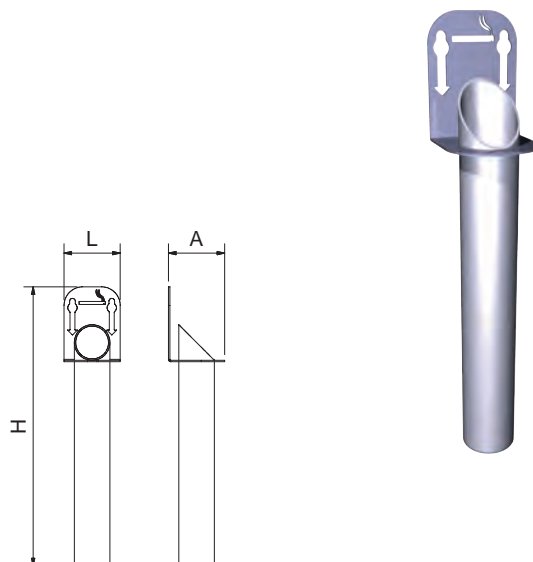

L	A	H	Kg	Barcode	€
60	60	298	0,4	080652	79,00

Cenicero mural NF

NF wall mounted ashtray
Cendrier mural NF

Características:

Este sencillo cenicero mural está fabricado totalmente en acero inoxidable. Su diseño permite ocupar el mínimo espacio en el interior o exterior de su negocio.

Perfecto para exteriores.

Fácil fijación a pared.

Desmontable para su limpieza y vaciado. Posibilidad de introducirlo en máquinas de lavado.

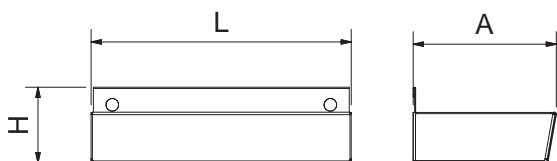

L	A	H	Kg	Barcode	€
207	114	60	0,36	080656	25,00

Characteristics:

This simple wall mounted ashtray is wholly made of stainless steel. It has been designed to occupy little space both in indoor and outdoor areas.

Ideal for outside

Easy to install.

Detachable for emptying and cleaning. It can be washed in the dish washer.

Caractéristiques:

Ce simple cendrier mural est fabriqué entièrement en acier inoxydable. Il a été conçu pour occuper peu d'espace.

Idéal pour l'extérieur, mais il peut être utilisé aussi à l'intérieur.

Facile à installer

Détachable pour la vidange et le nettoyage. Il peut être lavé dans le lave-vaisselle.

Cenicero melamina "Lucky"

Melamine ashtray "Lucky"
Cendrier en mélamine "Lucky"

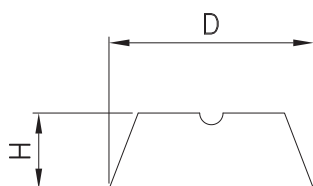

D	H	Gr	Barcode	€
13	35	112	486220	8,00



Cajones

Drawers
Tiroirs

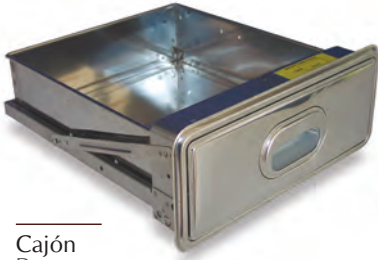

Cajón
Drawer
Tiroir

Características:

Cajones totalmente contruidos en acero inoxidable, acabado brillante. Los rodamientos de nylon en sus guías garantizan un estable movimiento de apertura y cierre, aun cuando esté cargado. Interior y exterior embutidos para aumentar su resistencia. Diseño elegante.

Characteristics:

Drawers completely made in stainless steel polished finished. Its nylon bearing in the rails guaranty a stable opening-closing movement, even when loaded. Hammered inside and outside to increase its strenght. Smart design.

Caractéristiques:

Tiroirs totalement construit en acier inoxydable avec finition brillante. Les roulements de nylon dans ses glissières garantissent le mouvement équilibré d'ouverture et de fermeture bien qu'il soit chargé. Interieur et extérieur embouti pour augmenter sa résistance. Dessin élégant.



Cajón con cerradura
Lock drawer
Tiroir avec serrure

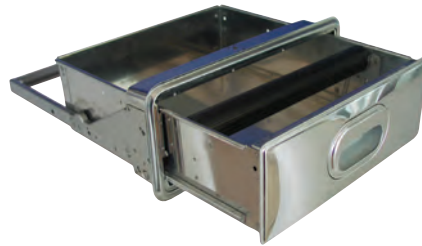

Cajón con golpeador para posos de café
Drawer with striker for coffee grounds
Tiroir avec dispositif pour faire tomber le marc de café



Cajón alto
Deep drawer
Tiroir haut

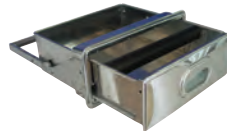
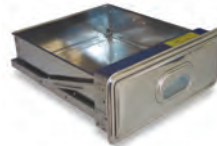
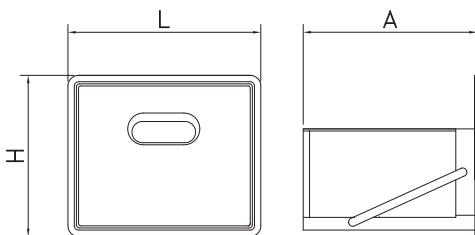
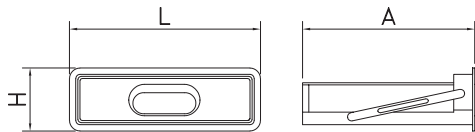
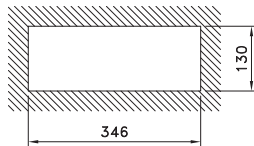

L	A	H	Kg	Barcode	€
---	---	---	----	---------	---

375 405 160 2,8 485402 133,00

375 405 160 2,9 485404 172,00

375 405 160 3,0 485406 156,00

470 495 410 5,2 485414 320,00

Cajón o tolva acoplado a estantería

Drawer or hopper coupled to shelves
Tiroir ou trémie accouplé aux étagères

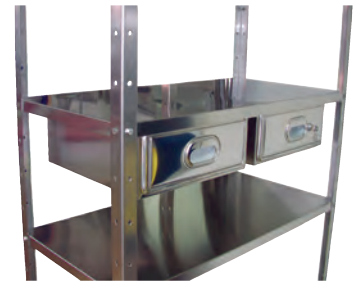

Modelo Model Model	Estanterías ancho 500 mm Shelving units depth 500 mm Rayonnages profondeur 500 mm		Estanterías ancho 600 mm Shelving units depth 600 mm Rayonnages profondeur 600 mm	
	Barcode	€	Barcode	€
	085430	258,00	085432	262,00
	085434	301,00	085436	304,00
	085438	268,00	085440	271,00
	085468	450,00	085470	458,00



Los precios de esta sección incluyen el cajón, el envolvente, los refuerzos y la mano de obra de acoplar a nuestros estantes.

Fringe, reinforcements, drawer and shelf fixing labour are included in the price.

Enveloppant, renforts, tiroir et la main d'œuvre pour les fixer aux étagères c'est inclus dans le prix.

Cajón o tolva preparado para acoplar a estantería por el cliente

Drawer or hopper designed to be coupled to shelves by the user
Tiroir ou trémie dessiné pour être accouplé aux étagères par l'utilisateur



Modelo Model Model	Estanterías ancho 500 mm Shelving units depth 500 mm Rayonnages profondeur 500 mm			Estanterías ancho 600 mm Shelving units depth 600 mm Rayonnages profondeur 600 mm			
	Composición Composition Composition	Unidades Units Unités	Barcode	€	Composición Composition Composition	Unidades Units Unités	Barcode
	1	085410	247,00	1	085410	249,00	
	2	085418		2	085420		
	1	085412	291,00	1	085412	293,00	
	2	085418		2	085420		
	1	085414	264,00	1	085414	266,00	
	2	085418		2	085420		
	1	085464	437,00	1	085464	443,00	
	2	085418		2	085420		



Estos cajones y tolvas están especialmente diseñados para ser acoplados mediante tornillos o remaches a nuestras estanterías. Los precios incluyen el cajón, el envolvente y los refuerzos necesarios para su fácil adaptación al estante.

These screw or rivet fixing drawers and hoppers are specially designed to be easily adapted to our shelves. Fringe, reinforcements, drawer and shelf fixing labour are included in the price.

Ces tiroirs et trémies de fixation par visés ou rivetages ont été dessinés par une facile adaptation à l'étagère Enveloppant, renforts, tiroir et la main d'œuvre pour les fixer aux étagères c'est inclus dans le prix.

Cajón o tolva acoplado

Drawer or hopper coupled
Tiroir ou trémie accouplé



Los precios de esta sección incluyen el cajón, la mano de obra y los materiales necesarios para acoplar estos elementos a los muebles que precisen. Usualmente se suelen acoplar en tajos de troceo, fregaderos, mesas de trabajo, etc.

The prices shown in this section include the drawer plus the labour as well as the necessary materials to couple these elements in the provided furniture. Usually they are coupled in shelves, chopping blocks, sinks, preparation tables, etc.

Les prix de ce partie comprennent le tiroir plus la main-d'oeuvre et les matériels nécessaires pour accoupler ces éléments a les meubles qu'ils aient besoin. Usuellement ils sont accouplés sur rayonnages, hachoirs à viande, eviers, tables de préparation, etc.

Cajón o tolva preparado para acoplar por el cliente

Drawer or hopper designed to be coupled by the user
Tiroir ou trémie dessiné pour être accouplé par l'utilisateur



Estos cajones y tolvas están especialmente diseñados para ser acoplados mediante tornillos o remaches. Incorporan un envoltorio taladrado en sus pestañas superiores de tal manera que puede adaptarse a cualquier mesa del mercado.

The screw or rivet fixing drawers and hoppers are provided with a stainless steel fringe pierced in the upper part in order to be adapted to any table.

Les tiroirs et trémies de fixation par visés ou rivetages incorporent un enveloppant en acier inoxydable perforé dans ses languettes supérieures tellement qu'il est possible l'adapter à quelque table.

Modelo Model Model		€
	085402	224,00
	085404	256,00
	085406	231,00
	085408	293,00
	085460	464,00
<small>Novedad</small>	085480	190,00
<small>Novedad</small>	085482	249,00

Modelo Model Model		€
	085410	207,00
	085412	251,00
	085414	224,00
	085464	431,00
<small>Novedad</small>	085490	140,00
<small>Novedad</small>	085492	205,00

Tolva abatible para posos de café
 Hinged hopper for coffee grounds
 Trémie à un abattant pour marc de café

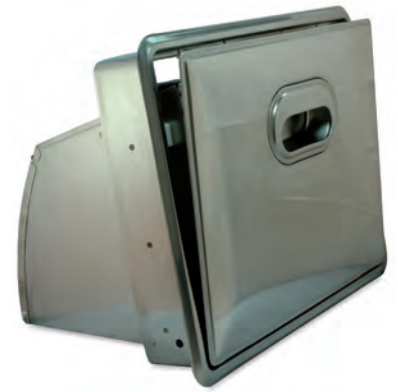
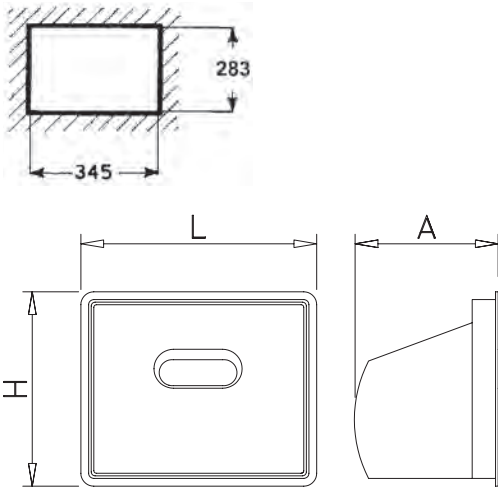

L	A	H	Kg	Barcode	€
370	240	303	3,53	485408	220,00

Puerta
 Door
 Porte

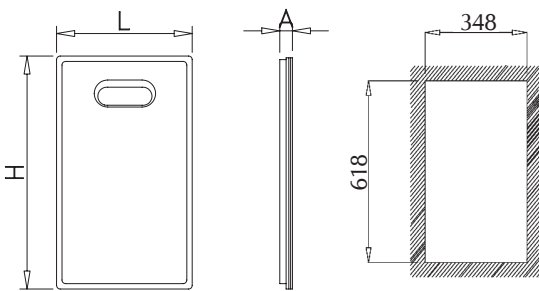

L	A	H	Kg	Barcode	€
373	35	643	6,8	485602	168,00

Repuesto golpeador de posos de café
 Spare striker for coffee grounds

Dispositif de remplacement pour faire tomber le marc de café



L	D	Kg	Barcode	€
320	40	1,85	485410	34,00

Kit golpeador para cajón pequeño
 Coffee grounds striker kit for small drawer

Barre pour petit tiroir de marc à café

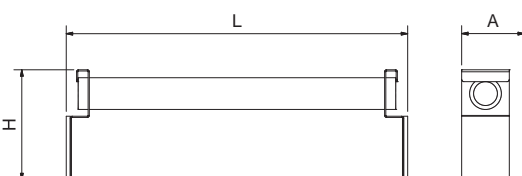

L	A	H	Kg	Barcode	€
430	79	139	2,5	2720108	37,00

Novedad
 sw
 nouveau

Ruedas

Wheels
Rouelles



Características:

Disponemos de dos tipos de rueda: una más económica, cuya estructura está fabricada en acero galvanizado, siendo su superficie rodante de goma, y otra construida en acero inoxidable, con su superficie rodante de nylon. El acero inoxidable y el nylon ofrecen una duración y resistencia garantizada, por lo que son ideales para mataderos, salas de despiece y demás sitios donde el grado de humedad sea elevado.

Characteristics:

Two sort of wheels are available: an economic one, which structure is made in galvanized steel, with a rolling surface in rubber, an another one made in stainless steel with its rolling surface in nylon. The stainless steel and the nylon offer a guaranteed length and resistance, and because of this, they are ideal for slaughterhouses, cutting up rooms, workshops, and places with high humidity concentration.

Caractéristiques:

Il y a deux types de rouelles, une plus économique, dont structure est fabriquée en acier galvanisé avec une surface roulante de caoutchouc, l'autre construite en acier inoxydable avec sa surface roulante en nylon. L'acier inoxydable et le nylon offrent une durée et résistance garanties, ce qui fait que ce soit idéal pour abattoirs, salles d'équarriment, ateliers et autres lieux avec une haute concentration d'humidité.

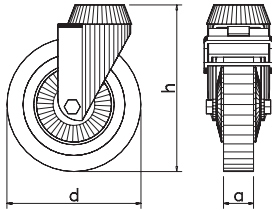

Inox - Nylon

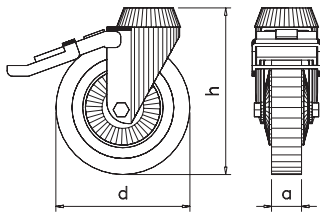

Galvanizadas
Goma



Resistencia por rueda Castor load strength Résistance de charge par rouelle							
d	a	h	Kg	Gr	Barcode	€	
80	33	106	100	570	485032	24,00	
130	40	157	180	890	485036	35,00	
80	33	106	100	810	485030	38,00	
130	40	157	180	1.140	485034	48,00	
75	23	94	50	300	485004	8,00	
125	32	155	100	725	485012	15,00	
75	23	94	50	370	485002	10,00	
125	32	155	100	800	485010	19,00	

Características:

Este apartado les será útil si lo que desean es acoplar ruedas a algún artículo de nuestro catálogo. Generalmente las ruedas suelen ser acopladas en estanterías, tajos de troceo, fregaderos, mesas, etc. La forma de aplicar los precios es sumar el precio de la rueda deseada mas el acoplamiento. Por ejemplo, tenemos una mesa que necesitamos que lleve ruedas y queremos obtener el precio de las ruedas colocadas. En primer lugar tendríamos que seleccionar una rueda entre las disponibles y en este caso seleccionamos la de acero inoxidable con freno de 80 mm de altura. La operación sería la siguiente:

4 ruedas del código 485030 + 4 acoplar rueda a pata de 40x40 mm código 085002.

Characteristics:

This part will be useful if what you wish is to assembly wheels to any article of our catalogue. Wheels are usually coupled in shelves, chopping blocks, sinks, tables, etc. The way of applying prices is to add the price of each one of the required wheels plus the assembly. For example, if you need a table with wheels and you want to obtain the price of the wheels assembled, first you should select one of the available wheels. In the case that you select the one in stainless steel of 80 mm height with brake, the result is as follows:

4 wheels code 485030 + assembly wheel to 40x40 mm leg code 085002.

Caractéristiques:

Cette partie vous sera d'utilité si vous desirez accoupler rouelles a quelque article de notre catalogue. En général les rouelles coutume d'être accouplées en rayonnages, hachoirs à viande, eviers, tableaux, etc. La forme d'appliquer les prices c'est ajouter le price du rouelle désirée plus le price de l'accouplement. Par exemple, si vous avez besoin d'un tableau avec rouelles et vous voulez obtenir le price des rouelles couplées, d'abord vous devriez sélectionner une rouelle entre les disponibles. Dans le cas de sélectionner celle d'acier inoxydable de 80 mm d'hauf avec frein, l'operation serait la suivante:

4 rouelles du code 485030 + accoupler rouelle dans empiètement 40x40 mm code 085002.



	€
Acoplar rueda a soporte de estantería Assembly wheel to shelving support Accoupler rouelle dans support de rayonnage	085004 12,65
Acoplar rueda a pata de 40x40 mm Assembly wheel to 40x40 leg Accoupler rouelle dans empiètement de 40x40	085002 20,00
⊛ Acoplar ruedas a soporte para mostrador de pescadería Assembly of castors to fish counter support Assemblage de rouelles au support d'étal à poisson	085008 40,00
⊛ Acoplar ruedas a boxes modulares Assembly of castors to modular boxes Assemblage de rouelles au boxes modulaires	085010 40,00
⊛ Acoplar ruedas a palet de jamones/embutidos Assembly of castors to palet for cured hams/ sausages and cured meat Assemblage de rouelles au palette pour jambons/charcuterie	085012 75,00

⊛ El precio comprende el montaje de 4 ruedas por elemento. El precio de las ruedas no está incluido.

The price includes the assembly of 4 castors per element. The price of the castors is not included.

Le prix comprend l'assemblage de 4 rouelles par élément. Le prix des rouelles c'est ne pas compris.

Características:

Con este producto usted podrá acoplar las ruedas del catálogo a nuestros artículos.

Characteristics:

This article will enable the fixing of any wheel of the catalogue to our products.

Caractéristiques:

Cet article vous permettra la fixation de quelque rouelle du catalogue à nos produits.

Kit de acoplamiento a rueda
Wheel fixing kit
Kit d'accouplement aux rouelle



Gr	€
200 085006	12,00

Adaptador enchufe tipo H

Type H plug adapter
Adaptateur pour prise électrique type H



Tensión Voltage Tension	Frecuencia Frequency Fréquence	Gr	Barcode	€
220 V	50 Hz	56	485878	6,00

Taco regulable para soporte de estantería

Adjustable block for shelving support
Taquet réglable pour supports de rayonnage



Características:

Material altamente resistente. Rosca interior reforzada. Cumplen con todas las normativas.

Para ángulo de 40x40x2 mm (Soportes estanterías)

Characteristics:

High resistance material, since it has a reinforced internal thread. It complies all the current norms.

For angled bars 40x40x2 mm

Caractéristiques:

Matériel d'haute résistance, puisqu'il a une filet intérieur renforcée. Il accomplit toutes les normes en vigueur.

Pour bars en angle de 40x40x2 mm

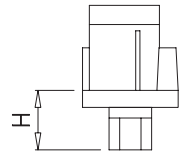

Gr	H _{min}	H _{max}	Barcode	€
45	28	50	411018	2,50

Tacos regulables para tubo

Adjustable blocks for tube
Taquets réglables pour tube



Características:

Material altamente resistente. Al llevar rosca interior cumplen con todas las normativas vigentes.

Characteristics:

High resistance material. Since it has thread inside, is in accordance with all the current norms.

Caractéristiques:

Matériel d'haute résistance. Puisqu'il a une filet intérieur, il accomplit toutes les normes en vigueur.

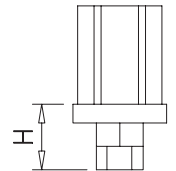

Para tubo de For tube of Pour tube de	Gr	H _{min}	H _{max}	Barcode	€
40x40x1 mm	45	28	50	409851	1,50
40x40x1,5 mm	40	35	60	409852	3,70

Tacos regulables altura especial para tubo

Special height adjustable blocks for tube
Taquets réglables hauteur spéciale pour tube

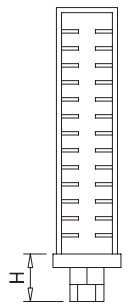

Para tubo de For tube of Pour tube de	Gr	H _{min}	H _{max}	Barcode	€
40x40x1 mm	115	30	105	409848	3,00
40x40x1,5 mm					

Tacos de plástico para tubo

Plastic blocks for tube
Taquets de plastique pour tube

Características:

Para tubo de 1 mm y 1.5 mm de espesor. Material altamente resistente. Las aletas dispuestas horizontalmente garantizan un máximo ajuste.

Characteristics:

High resistance material. The flaps horizontally disposed guaranty the maximum adjustment.

Caractéristiques:

Matériel d' haute resistance. Les ailettes ordonnées horizontalement garantissent le maximum ajustage.

Para tubo de For tube of Pour tube de	Gr	Barcode	€
Ø 20 mm	3	409886	0,15
Ø 25 mm	4	409888	0,16
Ø 30 mm	5	409890	0,17
Ø 35 mm	8	409892	0,21
Ø 38 mm	9	409894	0,22
Ø 42 mm	10	409896	0,23

Para tubo de For tube of Pour tube de	Gr	Barcode	€
20x10 mm	2	409812	0,14
20x20 mm	4	409810	0,15
25x25 mm	5	409808	0,16
30x30 mm	8	409806	0,19
40x20 mm	6	409804	0,21
40x30 mm	9	409803	0,24
40x40 mm	11	409802	0,27



Funda antivibradora para taco regulable

Antivibrator cover for adjustable blocks
Base anti-vibrateur pour taquets réglables

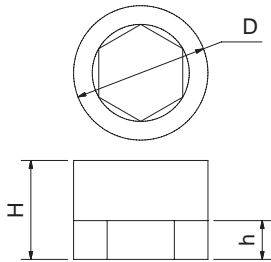

D	H	h	Gr	Barcode	€
35	25	10	15	409952	1,10

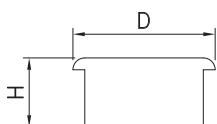

H	D	Gr	Barcode	€
35	72	90	409835	15,00

Pasacable inox

Stainless steel grommet
Passe-câbles en acier inoxydable



Aros para tolva de desbarasado

Rings for waste chutes
Cercles pour trémies à déchets

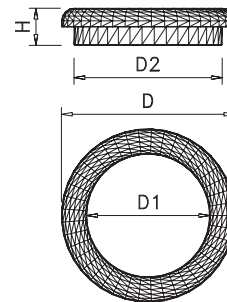

D	D1	D2	H		Gr		€
235	165	200	44		450	486402	16,00
235	165	200	44		450	486406	16,00
235	165	200	44		450	486408	16,00
235	165	200	44		450	486410	16,00
235	165	200	44		450	486412	16,00

Tapa para aro de tolva de desbarasado

Lid for Rings for waste chutes
Couvercle pour cercles pour trémies à déchets

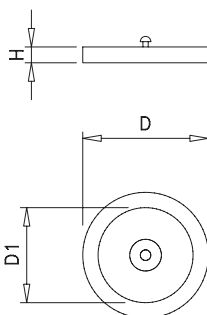

D	D1	H	Gr		€
238	180	30	210		486404 33,00

Limpiador de acero inoxidable

Stainless steel cleaner
Laveur d'acier inoxydable



Características:

Este producto de alta calidad tiene como principales ventajas su elevada evaporación y secado lo que proporciona una limpieza rápida, eficaz y duradera. No deja cercos ni restregones. Por su neutralidad no ataca el acero conservándolo en perfectas condiciones durante más tiempo.

Aplicación:

Este limpiador se recomienda para cualquier superficie de acero inoxidable.

Characteristics:

This high quality product has, as main advantage, a high degree of evaporation and drying, which provides a quick, effective and lasting cleaning. It does not leave any cleaning or rubbing traces. Because of its neutrality this product does not attack the steel and keeps it in perfect conditions for longer.

Use:

This cleaner is recommended for any kind of stainless steel surface.

Caractéristiques:

Ce produit d'haute qualité a comme principale avantage son élevé évaporation et séchage, ce qui rapporte un nettoyage rapide, effectif et durable. Ce ne fait pas traces des frottements. A cause de sa neutralité n'attaque pas l'acier et le conserve en parfait conditions pendant plus longtemps.

Applications:

On recommande ce nettoyeur pour quelque surface en acier inoxydable.

lit	Gr		€
1lts	850	380004	16,00

Spray de acero inoxidable

Stainless steel spray
Erspray acier inoxydable



Reacondicionamiento de piezas de acero inoxidable, rejillas, tuberías, instalaciones exteriores, decoración, etc.

Es un revestimiento superficial, a base de pigmentos minúsculos de acero inoxidable y resina acrílica, que se adhiere a superficies metálicas, vidrio, madera, piedra, papel, plástico, etc.

Soporta temperaturas de hasta 300 °C durante periodos cortos. A las 4-6 horas después del secado es resistente a la abrasión y a agentes químicos.

Repairing of stainless steel parts, grills, pipes, outdoor installations, decorating, etc.

It is a superficial coating, from stainless steel and acrylic resin micro-pigments, which is adhered to metallic surfaces, glass, wood, stone, paper, plastic, etc.

It supports temperatures up to 300°C for short periods. Between 4-6 hours after having dried, is abrasion and chemical agents resistant.

Aménagement des pieces en acier inoxydable, grillages, conduits, installations extérieures, décoration, etc.

C'est un revêtement superficiel, composé de micro pigments en acier inoxydable et résine acrylique, qui s'adhère aux surfaces métalliques, verre, bois, pierre, papier, plastic, etc.

Il supporte des températures jusque 300°C pendant périodes bréfs. Après 4-6 heures de sechage c'est resistant a l'abrasion et aux agents chimiques.

lit	Gr		€
400 ml.	410	480002	16,00

analytical index
index analytique

Letter	Item	Page
A	Abreojas	92
	Accesorios para fuentes	134
	Afilador de cuchillos	100
	Aguja de mechar	
	Alcayata	
	Aplastafiletos	
	Arandelas	
	Armario estantería	
	Armario esterilizador de	
	Armario para productos	
	Armarios de puertas corre	
	Armarios esterilizadores	
	Armarios esterilizadores	
	Aro para tolva de desbarra	
	Asa universal para cubetas	
Atril con cajón		
B	Bacaladera	
	Banco vestuario	
	Horizontal	
R	Rabot pour fibres	76
	Raclette grill	81
	Rame	75
	Rayonnages modulables	29
	Rayonnages modulables	29
	Rechagements pour	
	Rechages et compléments	
	Rechages pour étaux à	
	Rechages pour exten	
	Rechages pour robin	
	Renfort soudés aux étaux	
	Rivetages tubulaires	
	Robinet à coude une	
	Robinet à levier M-M	
	Robinet pour monoco	
H	étagères lisses de 0,8 mm	176
	étagères lisses de 1,5 mm	172
		175
		173
		181
	Hook - S model rod hooks without point	
	Hook - Sausage hook with lamb hook	
	Hook - Single sausage hooks	
	Hook - Standard forged kooks	
	Hook - Wall-mounted forged hook	
Hopper - Hinged hopper for coffee grounds		
	141	
	140	
	Espanol 246	
	Esp 246	
	Esp 246	

Indice
analítico

Indice analítico



Índice analítico

A

Abrebotellas	166
Abrelatas	140
Abrelatas industrial	141
Abrelatas tenaza	140
Abrestras	146
Acanalador	116
Accesorios para fuentes M 3/8"	202
Accesorios para grifos de manguera	265
Accesorios para mesas jamonerías	293
Adaptador para canal modular ranurado	229
Adaptadores para carros de servicio	312
Afilador de cuchillos manual de sobremesa	130
Afilador de cuchillos manual de sobremesa gris/negro	130
Afilador de cuchillos manual de sobremesa rojo/negro	130
Afilador de cuchillos profesional	131
Afilador Detectosteel	131
Agua caliente para fregaderos autónomos	218
Agua caliente para lavamanos portátiles autónomos	178
Aguja de mechar	114
Alcayata	70
Anillo acero inox antigoteo para botella de vino	169
Aparcamiento para carros	63
Aplasta hamburguesas circular	97
Aplasta hamburguesas de molde ovalado	98
Aplasta hamburguesas de molde redondo	98
Aplastafiletas	117
Aplastafiletas circular	117
Arandelas	72
Armario botiquín	387
Armario estantería 2 puertas	309
Armario esterilizador de cuchillos mediante Ozono	357
Armario inox esterilizador de utillaje y calzado	358
Armario para equipos informáticos	310
Armario para productos de limpieza	308
Armarios de esquina derecha con puertas abatibles	307
Armarios de esquina izquierda con puertas abatibles	307
Armarios de puertas abatibles	306
Armarios de puertas correderas	306
Armarios esterilizadores de cuchillos por rayos U.V.	356
Aros para tolva de desbarrasado	470
Asa universal para cubetas gastronorm	420
Asiento abatible	385
Atrapador de insectos Easy Trap	363
Atrapador de insectos Tephri Trap	363
Atril de acero inoxidable	310

B

Bacaladera	111
Balanza de cocina ultra-fina	149
Balanza mecánica de cocina	148
Banco inoxidable de vestuario con doble zapatero	335
Banco vestuario	335
Bandeja antideslizante Gastronorm 1/1	422
Bandeja de aluminio con asas para pizza 6 porciones	151
Bandeja de aluminio con mango para pizza 6 porciones	151

Bandeja de camarero especial jarras de cerveza	424
Bandeja de cambio	424
Bandeja de cambio rectangular con clip	425
Bandeja de cambio sencilla	424
Bandeja inoxidable con asa	423
Bandeja menú inoxidable	423
Bandeja panadería en malla inox	426
Bandeja para marisco	426
Bandeja para platos fríos	162
Bandeja pastelera en acero inoxidable	425
Bandeja pastelera perforada	426
Bandejas aluminio antiadherente	425
Bandejas de camarero	424
Bandejas de presentación	422
Bandejas de presentación BP1	422
Bandejas de presentación BP2	423
Bandejas de presentación BP3	423
Bandejas de presentación inox	422
Barra de apoyo abatible. Anclaje a suelo	385
Barra de apoyo mural horizontal	385
Barra de apoyo mural horizontal pasamanos	385
Barra de apoyo mural para bañera	384
Barra de apoyo mural para lavabo	384
Barra de apoyo mural vertical	384
Barra de apoyo mural vertical abatible	384
Barra mural con ganchos	53
Barreños	391
Bases inoxidables para transporte de pizzas	153
Batidor	138
Biberones de cocina	146
Bisagra de piano inox	72
Bolsa térmica para transporte de pizza	153
Bolsas de vacío	441
Bomba de vacío para botella de vino	169
Botas de agua PVC/Nitrilo	346
Botelleros	432
Bowls en policarbonato transparente	158
Boxes modulares	33
Buzón inoxidable premium	455
Buzón inoxidable premium-maxi	455

C

Cafetera express inox	171
Caja alimentaria apilable	428
Cajón acoplado a estante 2/1 Imagine	33
Cajón o tolva acoplado	464
Cajón o tolva acoplado a estantería	463
Cajón o tolva preparado para acoplar a estantería por el cliente	463
Cajón o tolva preparado para acoplar por el cliente	464
Cajones	462
Calentador de agua instantáneo	192
Calentador de platos para estantes de sobremesa	303
Calzo elevador para fibras	85
Cambia pañales	396
Campana extractora mural acero inoxidable	337

Canal colector	227
Caño ducha extraíble	257
Caño fijo	257
Caño giratorio	257
Caño mural giratorio	257
Cañón de ozono	354
Caperuza porta-cenicero para papelera	460
Carnicero Victorinox	123
Carro bañera para elevador	314
Carro de limpieza	387
Carro de manutención con ruedas y desagüe	313
Carro de recogida	312
Carro Euronorm	315
Carro para canales	315
Carro para transporte de barriles	454
Carros de servicio	311
Carros de transporte	315
Carros Gastronorm	314
Cartelas	19
Cartelas abatibles para estantes murales	56
Cartelas Imagine	31
Cascanueces	165
Cazo	137
Cazo para salsa en acero inox	150
Cebollero Aleman	122
Cenicero con soporte y depósito de arena	459
Cenicero melamina "Lucky"	461
Cenicero mural NF	461
Cenicero papelera	459
Cenicero para espacios reducidos	461
Cenicero para espacios reducidos de pié	460
Centro de reciclado 4 elementos	373
Cepillo + palo polipropileno alimentario	388
Cepillo antiestático estrecho para maquinaria	389
Cepillo barrer suave	388
Cepillo cerdas inox	84
Cepillo de mano multiusos metal detectable	388
Cepillo limpiaúñas de usos personal	406
Cepillo rascador de fibras	84
Cepillos lavavasos	434
Cesta alimentaria plegable	427
Cesta de supermercado sencilla	428
Cesta para platos	429
Cesta rectangular	162
Cesta redonda	162
Cesta simple	429
Cesta supermercado	429
Cestas alimentarias	427
Cestillo para cubiertos	430
Cestos de vasos para lavavajillas	430
Chaira cerámica	129
Chaira diamantada	129
Chairas	129
Champanera acero inox	171
Check de cloro	352
Chuletero	93
Cierra bolsas inox	442
Cocinero ILAFLON RESIST™	121

Cocinero de titanio	119
Coctelera	170
Colador	138
Colador/Tamizador	138
Columna de acero inoxidable para dispensadores	449
Columna inoxidable con dispensador "Su turno"	449
Columna señalización con cinta	448
Columnas para tubo	42
Columnas perforadas para pletinas	40
Composiciones básicas sistema imagine central	29
Composiciones básicas sistema imagine mural	28
Composiciones básicas sistema imagine mural suspendida	24
Conjunto aros de emplatar	89
Conjunto de 6 aros de emplatar en acero inox	141
Conjunto de conos para relleno de crema en acero inox	155
Conjunto de ducha y pulsador profesional	268
Conjunto de ducha, grifo monomando y mástil	268
Conjunto dispensador de guantes y bolsas colgantes	379
Conjunto dispensador de salsas	147
Conjunto dispensador de salsas y recipiente inox	147
Conjunto dispensador de guantes y bolsas en rollo	379
Conjunto lavamanos y fregadero mural	190
Conjunto lavamanos y fregadero XS	190
Conjunto peto, jabonera y dispensador	178
Conjunto rompe marisco	159
Conjunto sal y pimienta	165
Conjuntos dispensadores de guantes y bolsas con papeleras	380
Consigna mural para carros	457
Consigna para carros	456
Consigna para carros con taquilla	456
Consumibles para dispensadores	383
Contenedor de desperdicios	368
Contenedor de desperdicios con tapa y ruedas	369
Contenedor de desperdicios y reciclaje	373
Contenedor de plástico con tapa 55 litros	377
Contenedor de reciclaje vertical	374
Contenedor Gastronorm aislamiento térmico	420
Contenedor higiénico sanitario con apertura a pedal	377
Contenedor inox para vaciado de bandejas de comida rápida	299
Contenedor inox para vaciado de bandejas de comida rápida	372
Contenedor inox.c/tapa y ruedas especial panadería	371
Contenedor inoxidable con tapa	370
Contenedor inoxidable con tapa de apertura a pedal	370
Contenedor isotermo	421
Contenedor para hielo	314
Contenedor para reciclado	376
Contenedor para transporte de cuchillos	133
Contenedor para transporte de cuchillos con ruedas	133
Contenedor para transporte de hielo	313
Contenedor porta-bolsas con tapa y ruedas	370
Contenedor porta-bolsas sistema tijera, apertura a pedal	371
Copa en policarbonato	163
Copa helado	411
Corta mariscos forjado	165
Cortador de pizza	152
Cortador de pizza profesional	152
Cortadora de fiambres manual	145
Cortadora de masa de pizza	150

Cortar pan	113	Decorador de fruta	116
Cortina de ozono especial pescaderías	354	Defensa de esquina tubular 90°	62
Cortinas de lamas de PVC	456	Deglon Meeting 3 piezas	120
Cronómetro de cocina	352	Delantal anti salpicaduras	342
Cronómetro digital de cocina	352	Delantal de escay	342
Cruces para tubo	64	Delantal de protección en malla de acero inoxidable	342
Cubertero	430	Descorazonador	116
Cubertero plástico gris Gn 1/1	431	Deshuesador	124
Cubeta de inducción	421	Deshuesador flexible	124
Cubetas Gastronorm alta temperatura	416	Deshuesador semiflexible	124
Cubetas gastronorm lisas	412	Deshuesar carne	94
Cubetas gastronorm perforadas	413	Deshuesar jamón	109
Cubetas Gastronorm policarbonato	414	Deshuesar Victorinox	123
Cubetas GN para identificación de alérgenos	417	Desollar	95
Cubetas para helado	410	Desollar vaca	94
Cubierta basculante para cubetas Gastronorm 1/1	437	Despellejar Victorinox	123
Cubo antiestático de 15 litros con asa	390	DetectoGrip, Serie detectable	124
Cubo de plástico metal detectable	390	Dispens.de rollos de papel higiénico inoxidable	402
Cubo industrial asa de acero inoxidable	391	Dispensador automático de toallas	404
Cubo pedal baño con papelera interior	377	Dispensador de bobina industrial	405
Cubo plástico con asa metálica para fregar	391	Dispensador de bolsas	379
Cubos de acero inox	391	Dispensador de bolsas colgantes	381
Cubre aperitivos BC	436	Dispensador de bolsas en rollo	381
Cuchara de cocina	137	Dispensador de bolsitas higiénicas	403
Cuchara de mesa	164	Dispensador de guantes	380
Cucharón de servir	137	Dispensador de papel higiénico modelo nube	404
Cuchilla de golpe	92	Dispensador de papel higiénico triple	403
Cuchillas de repuesto para cepillo rascador	85	Dispensador de papel mecha	405
Cuchillería cerámica	118	Dispensador de papel mecha en acero inox	405
Cuchillería con revestimiento antiadherente ILAFLON RESIST™	121	Dispensador de papel mini-mecha modelo nube	404
Cuchillería de Arcos	125	Dispensador de rollos de papel higiénico	402
Cuchillería de fabricación alemana	122	Dispensador de tickets su-turno	448
Cuchillería profesional para Camiceros	92	Dispensador de tissues, guantes, toallas, etc.	383
Cuchillería titanio	119	Dispensador de toallas	403
Cuchillería Victorinox	123	Dispensador de toallas modelo nube	404
Cuchillo antioxidante para verduras	113	Dispensador de vasos	304
Cuchillo cocina de cerámica	118	Dispensador de vasos	433
Cuchillo de chef contrapesado	126	Dispensador de vasos universal	432
Cuchillo de mesa corte liso	164	Dispensador en acero inoxidable de toallas de papel	403
Cuchillo de mesa modelo chuletero	164	Dispensador inox para cepillos de limpieza de manos y uñas	406
Cuchillo de mesa modelo Chuletón	164	Dispensador mural de bobina industrial	405
Cuchillo deshuesado contrapesado	126	Dispensador mural de papel alimentario	381
Cuchillo francés inyectado Adherent +	96	Dispensador y cepillos para limpieza de manos y uñas	406
Cuchillo multiusos y pelador contrapesado	126	Dispensadores de bobinas para envolver	382
Cuchillo Panero de cerámica	118	Dosificador de gel-espuma	398
Cuchillo para despiece	124	Dosificador de jabón	398
Cuchillo sangrado	124	Dosificador de jabón encastrable	399
Cuchillo Santoku contrapesado	126	Dosificador de jabón inox	399
Cuchillos contrapesados	126	Dosificador de jabón modelo nube	398
Cuelga copas en varilla	433	Dosificador de salsas	147
Cuelga-copas	433	Ducha horno H de 1/2"	261
Cuencos	158	Ducha de gran alcance H de 1/2"	261
Cuencos para salsas	158	Ducha horno enrollable bajo encimera	262
Cutter combi (Metal detectable)	454	Ducha horno enrollable H de 1/2"	261
Cutter con cierre seguridad (Metal detectable)	454	Ducha mural de emergencia	386
		Ducha para horno pulsador	262

D

Decorador

116

E

Embellecedor para tocho	71
Embudo	146
Enchufe con mando a distancia	367
Enfriador de agua	202
Enrollador de maki higiénico	90
Envasadora al vacío	441
Envolvedora de sobremesa	442
Equilibrador	449
Escalones inox	450
Escalones para vitrinas	434
Escamador	111
Escamador EC	111
Escanciador de vino	169
Escurreador de fibras de corte	84
Escurreador de ollas regulable	139
Escurreador de verduras	139
Escurreadores de platos y vasos	208
Espátula de plástico antiestático	388
Espátula de silicona y acero inox	155
Espátula mantequilla	114
Espátula para planchas de cromo-duro	149
Espátula para preparación pizza en acero inox	153
Espátula pastelera	114
Espátula plancha	114
Espátula plástica, metal detectable	387
Espátulas	137
Especiero inox con tres niveles	143
Espejo inox	396
Espumadera	138
Esquinar	94
Esquinar curvo	94
Estante abatible de fibra para punto de venta portátil de jamones	107
Estante especial microondas	14
Estante mural de fibra abatible	20
Estante mural inclinado para cestas de lavavajillas	21
Estante mural porta-barquetas	20
Estante mural regulable serie imagine	15
Estanterías de sobre mesa	17
Estanterías modulares con estantes lisos de 0,8mm	9
Estanterías modulares con estantes lisos de 1,5mm	9
Estanterías suspendidas	16
Estantes de suelo	19
Estantes fibra Imagine	32
Estantes Inox Imagine	32
Estantes lisos para estanterías modulares	10
Estantes murales	18
Estantes murales cartelas modelo compacto	14
Estantes murales de tubo	14
Esterilizador automático de manos	397
Esterilizador de cuchillos mediante agua caliente para adosar	355
Esterilizador de cuchillos por ozono para adosar	355
Estropajo para tablas de corte	85
Europalet encajable liso	451
Europalet higiénico reforzado	452
Expositores de grifería	244
Extensión cesta simple	429
Exterminado de insectos mediante parrilla eléctrica serie UK-INOX	361

Exterminador de insectos mediante trampa adhesiva serie BC	364
Exterminador de insectos mediante trampa adhesiva serie MR	362
Exterminador de insectos mediante trampa adhesiva serie UL	361
Exterminador de insectos serie SP-80	362

F

Fiambre	99
Fiambre dos mangos	99
Fibra de colores intercambiables	86
Fibra para corte de pan	87
Fibra para corte de pan con recogemigas	87
Fibras chuleton rectangulares	158
Fibras de polietileno a medida	81
Fibras de polietileno estándar	80
Fibras de polietileno por planchas	81
Fibras GN	83
Fileteador flexible Victorinox	123
Filetear alemán	122
Filetero	93
Filtro aromatizante para urinarios	392
Filtro inoxidable para campana extractora	337
Fluxómetro para WC	260
Fondos perforados para cubetas Gastronorm	413
Fondos perforados para cubetas Gastronorm alta temperatura	416
Fondos perforados para cubetas Gastronorm policarbonato	415
Fondos perforados para recipientes de polipropileno	419
Francés todos usos	96
Fregadero especial para escayolas	222
Fregadero portátil automático agua fría	219
Fregadero portátil automático agua fría y caliente	220
Fregadero vertedero	222
Fregaderos	206
Fregaderos autónomos con una cubeta y escurridor	218
Fregaderos colgantes con cartelas	210
Fregaderos colgantes con faldón y palomillas	212
Fregaderos con puertas de corredera y abatibles	216
Fregaderos con soporte	214
Fregaderos de gran capacidad dos cubetas	221
Fregaderos de gran capacidad una cubeta	221
Fregaderos para encastrar	208
Fregaderos para lavavasos y lavaplatos	209
Fregaderos para soldar	205
Fregaderos soldados a mesa	305
Fuente de agua fría Cold+	199
Fuente de columna de pedal sin refrigeración	200
Fuente de columna sin refrigeración	200
Fuente de fijación mural sin refrigeración	201
Fuente mural de esquina sin refrigeración	201
Fuente mural redonda sin refrigeración	201
Fuentes de agua fría, caliente y del tiempo Futura	198
Funda antivibradora para taco regulable	469

G

Gafas antiproyecciones	346
Gancho 3 puntas	49
Gancho cuelga bolsas	49
Gancho de arrastre	50

Gancho de cordero en varilla	45	Grifo giratorio sobremesa dos aguas	248
Gancho de varilla modelo "J" con pestaña	44	Grifo giratorio sobremesa dos aguas ¼ de vuelta caño bajo	250
Gancho de varilla multifunción	49	Grifo giratorio sobremesa dos aguas serie 1/4 de vuelta	248
Gancho giratorio modelo "J"	50	Grifo giratorio sobremesa dos aguas serie extrabajo	250
Gancho giratorio modelo "S"	50	Grifo giratorio sobremesa un agua 1/4 vuelta caño alto	250
Gancho giratorio salchichero	49	Grifo llenajarras	259
Gancho jamonero atornillar	48	Grifo manguera enrollable inoxidable serie compacto	263
Gancho jamonero para pletina	48	Grifo manguera enrollable profesional plus	263
Gancho salchichero con gancho de cordero	51	Grifo manguera enrollable serie básico	264
Ganchos cartela fijo y giratorio	52	Grifo manguera enrollable serie inoxidable	264
Ganchos de varilla modelo "C"	48	Grifo mezclador sobremesa con mandos 1/4 de vuelta	249
Ganchos de varilla modelo "J"	46	Grifo monoblock electrónico con selector de temperatura Funcionamiento a pilas	256
Ganchos de varilla modelo "S"	46	Grifo monomando bidé	266
Ganchos de varilla modelo "S" sin puntas	47	Grifo monomando lavabo	266
Ganchos de varilla tipo "S" y "J" dobles sin puntas	47	Grifo monomando mural de codo 2 aguas serie monoblock elevado	252
Ganchos forjados modelo atornillar	45	Grifo monomando mural de codo dos aguas serie monoblock-bajo	252
Ganchos forjados modelo normal	44	Grifo monomando mural de codo para dos aguas	252
Ganchos forjados modelo pestaña	44	Grifo monomando sobremesa caño alto para fregadero	246
Ganchos forjados modelo recibir	45	Grifo monomando sobremesa caño giratorio elevado	247
Ganchos pesadores	68	Grifo monomando sobremesa con caño bajo	250
Ganchos salchicheros dobles	51	Grifo monomando sobremesa de codo dos aguas	247
Ganchos salchicheros sencillos	51	Grifo monomando sobremesa de codo dos aguas serie monoblock	247
Garras galvanizadas para tirantes	60	Grifo monomando sobremesa de codo dos aguas serie Monoblock elevado	248
Gaveta expositora	438	Grifo monomando sobremesa de codo elevado	249
Generadores de ozono inyectado para interior de cámaras frigoríficas	353	Grifo monomando sobremesa de columna	254
Giratorio extra bajo	257	Grifo monomando sobremesa extensible de codo	246
Grifo clinic expert	256	Grifo monomando sobremesa extensible de codo leva larga	246
Grifo cocina monomando sobremesa alto de acero inoxidable	245	Grifo monomando sobremesa giratorio dos aguas	247
Grifo cocina monomando sobremesa cuello de cisne de acero inoxidable	245	Grifo mural de 1 agua con pomo aislante caño alto	252
Grifo cocina monomando sobremesa de acero inoxidable	245	Grifo mural de 1 agua con pomo aislante caño bajo	253
Grifo cocina sobremesa doble función de acero inoxidable	249	Grifo mural de codo un agua	251
Grifo columna sobremesa 2 aguas pomo aislante	253	Grifo mural de dos aguas cuarto de vuelta	251
Grifo de columna orientable sobremesa 2 aguas monomando	254	Grifo mural dos aguas 1/4 vuelta	251
Grifo de columna orientable sobremesa de un agua	254	Grifo mural electrónico funcionamiento a pilas	256
Grifo de columna orientable sobremesa pomo aislante	253	Grifo mural monomando baño / ducha	267
Grifo de manguera enrollable serie profesional	262	Grifo mural monomando ducha	267
Grifo de sobremesa dos aguas con pomo aislante	253	Grifo para lavabo de 1 agua	266
Grifo ducha inox sobremesa dos aguas monomando	240	Grifo sobremesa de un agua serie cuarto de vuelta	244
Grifo ducha monomando sobremesa dos aguas serie doméstico	246	Grifo temporizado dos aguas	267
Grifo ducha mural cuarto de vuelta con levas	236	Grifo temporizado para urinario	260
Grifo ducha mural dos aguas monomando	235	Grifo temporizado un agua	267
Grifo ducha sobremesa básico	232	Grifos ducha sobremesa dos aguas	234
Grifo ducha sobremesa básico dos aguas extra bajo	242	Grifos ducha sobremesa un agua	233
Grifo ducha sobremesa básico dos aguas extra bajo con caño	242	Grifos para fuentes de agua	259
Grifo ducha sobremesa doble entrada, dos aguas monomando codo	237	Guante alimentario anticorte	343
Grifo ducha sobremesa dos aguas 1/4 vuelta	239	Guante anticalórico hasta 150°	343
Grifo ducha sobremesa dos aguas modelo accionamiento extensible	243	Guante anticorte industrial	345
Grifo ducha sobremesa dos aguas modelo accionamiento extensible con caño	243	Guante anti-salpicaduras aceite hirviendo	343
Grifo ducha sobremesa dos aguas monomando codo	237	Guante de piel industrial	345
Grifo ducha sobremesa dos aguas monomando leva	240	Guante de protección química	345
Grifo ducha sobremesa dos aguas monomando sin soporte a pared	241	Guante de vinilo azul desechable	344
Grifo ducha sobremesa monomando dos aguas extrabajo	241	Guante para pescadero	343
Grifo ducha sobremesa monomando dos aguas extrabajo con caño	241	Guantes de cinco dedos ambidiestro en malla de acero inoxidable	341
Grifo ducha sobremesa serie doméstico con piña	242	Guantes de nitrilo para uso alimentario	345
Grifo ducha sobremesa, dos mandos 1/4 vuelta	238	Guantes para frío extremo en piel hasta -20°C	344
Grifo electrónico temporizado para urinario	260	Guantes para frío extremo en PVC hasta -20°C	344
Grifo giratorio sobremesa 1/4 vuelta un agua caño bajo	251	Guardavivos exterior de acero inoxidable	67

Guardavivos interior de acero inoxidable	67
Gubia deshuesar jamón	108

H

Hacer agujero de desbarasado a estantes Imagine	32
Hacha de bombero con mango de fibra	407
Hacha de cámara con mango de fibra	407
Hojas de repuesto para espátulas cromoduro	149

i

Indicador de suelo mojado	387
Isla de cocina inox con encimera de granito	290
Isla de cocina inox con encimera de madera	290

J

Jabonera	394
Jabonera electrónica (funcionamiento a pilas)	399
Jamón serrano	108
Jamón serrano alveolado punta redonda	108
Jamón serrano virola	108
Jamonero ILAFLON RESIST™	121
Jamonero alemán	122
Jamonero curvo	108
Jamonero giratorio basculante RT-3D	102
Jamonero giratorio mural RT-2D	102
Jamonero giratorio RT-2D	102
Jarra de agua 1,8 L	163
Jarra medidora con fondo antideslizante 1 lt	156
Juego de 4 esponjas de colores	389

K

Kit de acoplamiento a rueda	467
Kit de elevación	78
Kit de pletinas para estanterías	11
Kit de útiles para barbacoa	127
Kit electrónico para lavamanos y fregaderos funcionamiento a pilas	256
Kit golpeador para cajón modular	300
Kit golpeador para cajón pequeño	465
Kit para colgar utensilios	52
Kit para colgar utensilios Imagine	33
Kits de portarrollos de papel o film	382
Kits de portarrollos de papel o film serie Eco	382

L

Lagueros superiores Imagine	31
Laminador de tartas	154
Lámpara para calentar platos	303
Lagueros inferiores Imagine	30
Lavabotas	386
Lavamanos colectivos	191
Lavamanos de columna electrónico de agua fría y caliente	179
Lavamanos integral mural electrónico	189
Lavamanos integral mural pulsador rodilla	188
Lavamanos integral registrable electrónico	183
Lavamanos integral registrable pulsador de pie	180
Lavamanos mural con doble pedal de agua fría y caliente	188
Lavamanos mural con pedal de agua fría y caliente	188

Lavamanos mural de esquina serie XS	186
Lavamanos mural de palanca agua fría y caliente	184
Lavamanos mural de rodilla agua fría y caliente	187
Lavamanos mural de rodilla modelo RC de agua fría y caliente	187
Lavamanos mural electrónico con selector de temperatura	185
Lavamanos mural electrónico de agua fría y caliente	185
Lavamanos mural electrónico de agua fría y caliente	189
Lavamanos mural serie XS dos aguas	186
Lavamanos mural serie XS pulsador rodilla	184
Lavamanos portátil autónomo	176
Lavamanos portátil autónomo automático doble pulsador, agua fría y caliente	177
Lavamanos portátil gran caudal	176
Lavamanos registrable autónomo eléctrico un pulsador agua fría	177
Lavamanos registrable con doble pedal de agua fría y caliente	182
Lavamanos registrable con pedal de agua fría y caliente	182
Lavamanos registrable con pedestal doble pulsador agua fría y caliente	181
Lavamanos registrable con pedestal un pulsador	180
Lavamanos registrable de rodilla agua fría y caliente	181
Lavamanos registrable electrónico de agua fría y caliente	183
Lavamanos registrable portátil autónomo grandes eventos	192
Lavamanos registrable serie XS	179
Lavaojos mural de emergencia en acero inoxidable	386
Lavaporcionador de helados mural	411
Lavaporcionador de helados para encastrar	410
Lenguado Arcos	125
Librador	139
Limpiador de acero inoxidable	470
Lira para cortar queso	99
Losetas antideslizantes	451

M

Maletín cuchillos cocinero Victorinox	127
Manopla anticalórica 350°	344
Manta para 7 útiles de cocina	135
Manta para cuchillos	135
Máquina para hacer churros y pastas	156
Marquesina para puertas	455
Mazo de picar	88
Mazo para chino	89
Medidor de PH	352
Menaje	136
Mesa barman	289
Mesa central con dos entrepaños. Especial cortadoras de fiambre	287
Mesa central con entrepaño. Especial maquinaria	287
Mesa central con estantes de sobremesa sistema Imagine	36
Mesa central de emplatado Imagine	35
Mesa central inox con encimera de cristal translúcido	290
Mesa de preparación de verduras	283
Mesa de terraza	288
Mesa jamonera RT-2D	105
Mesa jamonera RT-3D	105
Mesa mural con estantes sobremesa serie Imagine	36
Mesa mural de desbarasado con fregadero	282
Mesa mural de pre-lavado	285
Mesa mural desbarasado con puerta	283
Mesa mural desbarasado y reciclaje con puerta	373
Mesa mural sotanbanco con dos entrepaños	286

Mesa para marisco	325
Mesas centrales	279
Mesas centrales con reborde y desagüe	297
Mesas centrales encimera de polietileno	294
Mesas de despiece	298
Mesas de preparación centrales	295
Mesas de preparación murales	296
Mesas de preparación y lavado	284
Mesas de preparación y lavado	323
Mesas murales	279
Mesas murales con puertas	280
Mesas murales con puertas y cajones	281
Mesas murales con reborde y desagüe	297
Mesas murales de cajones	285
Mesas murales de chef	282
Mesas plegables con entrepaño	286
Modelo cocina	112
Modelo cocina Arcos	125
Modelo cocinero Arcos	125
Modelo cocinero forjado	112
Módulo expositor de frutas y verduras	327
Molde para laminar tartas 26/28 cms	154
Moldes cuadrados	141
Molinillo de hierbas	143
Molinillo juliana	144
Montantes para estanterías imagine suspendida	15
Mortero	89
Mostrador de pescadería	319
Mostrador de pescadería con soporte	318
Mostrador frutería	328
Mostrador frutería sobre obra	329

O

Oxigenador de vino	169
--------------------	-----

P

Pack de 6 colores de repuesto	86
Paelera de reciclaje con tapa basculante	375
Pala antiestática de mano	389
Pala cuadrada de aluminio para horno	151
Pala de acero inoxidable y polietileno	88
Pala de mano para hielo	326
Pala para hielo	326
Pala para hielo en acero inox	170
Pala para tartas / pizza en acero inox	156
Pala redonda de aluminio para horno	151
Palanca de un agua M-M 1/2"	258
Palet para embutidos	317
Palet para jamones	316
Paleta	137
Paleta de fibra para aplastar hielo	326
Paleta de plancha	114
Paleta oval en acero inox	152
Paleta oval en acero inox perforada	152
Paleta para servir pizza en acero inox	153
Paleta redonda aluminio	152
Panera mixta	87
Panero ILAFLON RESIST™	121

Panero Arcos	125
Pantalla antiproyecciones	346
Papelera	378
Papelera basculante en acero inoxidable	376
Papelera con tapa y pedal	378
Papelera con tapa y ruedas 70 l	371
Papelera de plástico con pedal	377
Papelera dispensador de bolsas de papel	381
Papelera inox de 70 lt apertura frontal	376
Papelera modelo Design	378
Paragüero inox	443
Pasacable inox	469
Pasapuré profesional	144
Pataforma con freno para transporte de cestos de lavavajillas	454
Pedal de un agua M-M de 1/2"	258
Pedal mezclador de agua fría y caliente con palanca de bloqueo H-H-H- 1/2"	258
Pedal mezclador de agua fría y caliente M-M-M de 1/2"	258
Pelador	113
Pelador	115
Pelador	140
Pelador Arcos	125
Pelador de cerámica	118
Pelador de espárragos	115
Pelador de titanio	119
Pelar patas	96
Percha industrial de acero inoxidable	334
Percha industrial de acero inoxidable	444
Perchero	443
Perchero individual	395
Perchero mural de acero inoxidable	443
Perfil paragolpes ángulo exterior de fibra blanca	66
Perfil paragolpes ángulo interior de fibra blanca	66
Perfil paragolpes curvo mural de plástico	67
Perfil paragolpes recto de fibra blanca	66
Perfiles divisorios para cubetas gastronorm	420
Pescadero	110
Pescadero	111
Pescadero punta aguda	110
Pescadero punta redonda	110
Peto lateral reversible para mesas	304
Peto transparente imagine	34
Picador de masa de pizza en acero inox	150
Picador de tomate	145
Picadora manual	144
Pictograma en acero inoxidable	445
Pie de champanera	171
Pie inox para lavamanos mural colectivo	192
Pies centrales Imagine	30
Pies murales Imagine	30
Pimentero	142
Pincel de silicona y acero inox	155
Pincho antipalomas en acero inoxidable	455
Pincho brocheta	157
Pinza de servir	136
Pinza para bandeja de horno en acero inox	150
Pinza para barbacoa	136
Pinza para cubitos de hielo	170
Pinza para embutidos	109

Pinza para frituras	136
Pinza para servir jamón	109
Pinzas porta-precios imagine	34
Pizarra de led con atril	439
Pizarra de led mural	439
Plafón para calentar platos	303
Plafones para exposición de embutidos	54
Plaqueta	63
Plaqueta redonda	63
Plataforma rodante	453
Plato cuatro salsas	160
Plato de cocktail	160
Plato de presentación	159
Plato de presentación especial pulpo	159
Plato ducha inox	394
Plato ducha lacado	394
Plato giratorio	162
Plato giratorio de cristal	161
Plato pizza	159
Pletinas	43
Pollero	96
Porcionador automático de helado	411
Porcionadores de helado	411
Porta brochetas	157
Portacuchillos con doble alojamiento de sobremesa	133
Portacuchillos mural imantado	134
Portacuchillos mural imantado de acero inoxidable	135
Portacuchillos para adosar con envoltivo	132
Portacuchillos para adosar en chapa	134
Portacuchillos para adosar en varilla	134
Portacuchillos inox portátil	359
Portacuchillos portátil	132
Portajamones	103
Portalacones en acero inoxidable	104
Portanotas mural	431
Portaprecios en varilla inox con base	440
Portaprecios en varilla inox para pinchar	440
Porta-precios Imagine	34
Portarrollos papel higiénico	395
Prensa ajos	143
Prolongación modular para mostradores de pescadería	319
Protector auditivo	346
Puerta	465
Puerta rodante para contenedores	304
Puesto de lavado y desinfección	263
Puesto pescadero encimera polietileno	324
Pulsador no temporizado M-M de 1/2"	258
Pulsador temporizado M-M 1/2"	258
Puntilla	97
Puntilla	113
Puntilla ILAFLON RESIST™	121
Puntilla alemán	122
Puntilla de cerámica	118
Punto de venta portátil de jamones	106
Punzonador de embutidos	145

Q

Queseras Base Plastico	439
------------------------	-----

Queso	99
-------	----

R

Rallador	115
Rallador de queso	143
Rallador inox	144
Rampa loseta	451
Rasqueta antiestática flexible para masa sin agujero	388
Rasqueta para vitrocerámicas	149
Recipientes de polipropileno	418
Recoge verduras inox	117
Recogedor abatible antiestático con mango una pieza	390
Recogedor con palo metálico	390
Recogedor de mano inox	389
Recogedor inox	389
Recubrimiento modular para islas de congelación	436
Refuerzos soldados a estantes	11
Registrador de temperatura y humedad	351
Rejillas Gastronorm	419
Remaches tubulares	72
Remo	88
Repisa	395
Repuesto de fibras de polietileno para mesas	82
Repuesto de mazas de madera	79
Repuesto de mazas de madera para acoplar fibra superpuesta	79
Repuesto golpeador de posos de café	465
Repuestos fregaderos	224
Repuestos para aplasta hamburguesas	98
Repuestos para carros de servicio y recogida	313
Repuestos para consignas	457
Repuestos para contenedor de reciclaje vertical	375
Repuestos para contenedores inoxidables	376
Repuestos para esterilizadores	360
Repuestos para exterminadores de insectos	366
Repuestos para exterminadores de insectos serie BC	367
Repuestos para grifos	269
Repuestos para mostradores de pescadería	322
Repuestos para serruchos	97
Repuestos y accesorios para lavamanos	193
Repuestos y complementos para armarios y taquillas	335
Rizador de mantequilla	115
Rociador de ducha	268
Rodillo	88
Rueda de repuesto para taburetes	21
Ruedas	466
Ruedas acopladas	467

S

Sacacorcho navaja	166
Sacacorcho Tiroles	166
Sacacorchos eléctrico	167
Sacacorchos mural	167
Salero	142
Salmón Victorinox	123
Salsera 8 salsas	160
Salsera circular 6 salsas	160
Salsera rectangular 4 salsas	161
Salsera rectangular 6 salsas	161

Salseras de diseño 6 salsas	161
Salvamantel	165
Santoku Arcos	125
Santoku de cerámica	118
Sashimi de titanio	119
Secamanos inox con pulsador y tobera	399
Secamanos inox de bajo consumo	401
Secamanos óptico en ABS	400
Secamanos optico en ABS sin tobera modelo nube	400
Secamanos óptico inox satinado con tobera	400
Secamanos óptico inox satinado sin tobera	400
Secamanos óptico ultrarápido Jet-01	401
Secamanos ultrarápido	401
Separador de monedas y billetes	431
Separador para mostrador de frutería / pescadería	329
Separadores centrales de columna	41
Separadores de esquina de columnas	41
Separadores de grasas	230
Separadores para taquillas	334
Serrucho acero inoxidable	97
Set colgador sujeta-palos	444
Set de cepillo y soporte inoxidable para baño	393
Set de decoración	117
Set para corte de jamón	107
Sistema modular de canal ranurado	228
Soporte cartela fijo y giratorio para balanzas	52
Soporte central	53
Soporte Imagine	31
Soporte jamón RT	64
Soporte lateral	53
Soporte para cafeteras	434
Soporte sobremesa y mural porta-cubetas Gastronorm	13
Soporte sobremostrador para balanzas	435
Soporte sobre-mostrador para cortadoras de fiambre	287
Soportes de estantería	10
Soportes de suelo	62
Soportes laterales para tubo	54
Soportes puente con trasera	55
Soportes puente con trasera para tubo	55
Soportes puente sin trasera	55
Soportes puente sin trasera para tubo	56
Soportes rectos	55
Soportes rectos en tubo para recibir	54
Soportes rectos para recibir	54
Soportes rectos para tubo	56
Spray de acero inoxidable	470
Sujeciones de hierro para tirantes	60
Sumidero canal modular ranurado	228
Sumidero extra-bajo	226
Sumidero industrial sifónico salida horizontal	227
Sumidero sanitario salida horizontal	227
Sumidero sanitario salida vertical	226
Sumideros sifónicos salida horizontal	226
Sumideros sifónicos salida vertical	226

Taburete con ruedas	450
Taburete inox	450
Taco de plástico nylon Fisher	69
Taco galvanizado para techo tipo balancín	70
Taco regulable altura especial para tubo	468
Taco regulable para soporte estantería	468
Tacos de plástico para tubo	469
Tacos regulables para tubo	468
Tajo especial barbacoa	76
Tajo-expositor para mostrador de pescadería	326
Tajos de troceo de fibra con faldón	75
Tajos de troceo de fibra lastrados	75
Tajos de troceo de madera y fibra con faldón	77
Tajos de troceo madera con faldón	77
Tajos de troceo serie GE	76
Tamizador en acero inox	156
Tapa dosificadora de salsa con cubo	148
Tapa juntas de unión para mesas y fregaderos	305
Tapa para aro de tolva de desbarasado	470
Tapa para barreños	391
Tapa para caja alimentaria apilable	428
Tapa para canal modular ranurado	229
Tapa para cubertero plástico gris Gn 1/1	431
Tapa para cubrir cestos de lavavajillas	430
Tapa para Europalet encajable liso	451
Tapa polipropileno para identificación de alérgenos	417
Tapa soporte para cubos y ollas	222
Tapajuntas de acero inoxidable	67
Tapas de propileno GN de colores	419
Tapas herméticas para cubetas Gastronorm	413
Tapas para cubetas gastronorm	413
Tapas para cubetas Gastronorm alta temperatura	416
Tapas para cubetas Gastronorm policarbonato	415
Tapas para recipientes de polipropileno	418
Tapón Cava Cromado	168
Tapón de corona acero inox	168
Tapón hermético acero inox (2 uds.)	168
Tapón inox	168
Tapón vertedor cromado (2 uds.)	168
Taquilla - Consigna	457
Taquillas de 1, 2 y 3 puertas	324
Taquillas de 1, 2 y 3 puertas	332
Taquillas de 2, 4 y 6 puertas	333
Taza turca inox	393
Tenazas quita espinas	164
Tendedero retráctil	395
Tenedor de mesa	163
Tenedor de trinchar	115
Tenedor de trinchar EC	115
Tenedor marisco	165
Tensor para guantes malla	341
Termo	171
Termómetro digital para botellas de vino	170
Termómetros	347
Tijera desmontable multiusos	128
Tijera pescadero / cocina con protección	128
Tijera profesional	128
Tijeras de trinchar	128

T

Tabla de corte/pala	86
Taburete con ruedas	21

Tijeras multiusos	128
Tijeras pescadero	128
Tirafondos cabeza hexagonal	69
Tirante para balanzas regulable	61
Tirantes de techo para pletina	57
Tirantes de techo para pletina con varilla roscada	57
Tirantes de techo para tubo	58
Tirantes de techo para tubo con varilla roscada	59
Tirantes para balanzas	61
Toallero	394
Tochos de hierro cincado rosca métrica	53
Tolva abatible para posos de café	465
Tolva evacuación de desperdicios para adosar a tajos de troceo	435
Tomate	117
Topes para fibras	82
Tornillo cabeza allen rosca métrica	69
Tornillo cabeza mariposa tipo americano	70
Tornillo pasante con tuerca y contratuerca rosca métrica	70
Tornillos barraqueros con embellecedor	69
Tornillos cabeza hexagonal rosca métrica	68
Tornillos rosca chapa	69
Tornillos y tuercas para estantes	11
Tramo en esquina para canal modular ranurado	229
Tramo en T para canal modular ranurado	229
Tramos rectos para canal modular ranurado	228
Transpaleta de acero inoxidable	452
Transpaleta pintada	453
Triángulo	90
Triturador de hielo	145
Tubos	43
Tubos en escuadra	64
Tubos en forma de "T"	64
Tuerca ciega hexagonal con autoseguro	71
Tuerca mariposa tipo americano	72
Tuercas ciegas hexagonales rosca métrica	71
Tuercas hexagonales rosca métrica	71
Tuercas hexagonales rosca métrica con autoseguro	71

U

U en doble "T"	65
U en forma de "T"	65
U mixta en forma de "T"	65
U Sencilla	65
Universal dentado alemán	122
Urinaris inox	392
Utensilios para pasteleros	154
Utensilios para pizzería	150
Útil de centrado para corte de fruta	85
Útil de montaje Imagine	34
Util para picadora	89
Útil para sujección de jamones	64
Utilitario de cerámica	118

V

Vaciador doble	116
Válvula de desagüe Splus modelo doble	225
Válvula de desagüe Splus modelo simple	225

Válvula de desengrase de acero con tapón	337
Válvula mezcladora antiretorno M-H-M de 1/2"	259
Válvula mezcladora termostática M-M-M de 1/2"	259
Válvulas desagüe para marmita	255
Varillas roscadas rosca métrica	70
Vaso en policarbonato	163
Vegetales de titanio	119
Verduras Arcos	125
Visor su turno con mando	448
Vitrina bollería	437
Vitrina bollería doble piso	437
Vitrina cubre aperitivos	437
Vitrina expositora	438
Volteadora de tortilla inox	139

W

WC inox	393
---------	-----

Z

Zócalo curvo de acero inoxidable	67
Zócalo de acero inoxidable	67

Analytical index

#

¼ turn double inlet rotating tap with low profile spout	250
1/4 turn model double inlet rotating tap	248
2 doors shelving wardrobe	309
4 elements recycler	373
4 piece sponge set - diferent colors	389

A

ABS Automatic hand dryer without nozzle, Cloud model	400
ABS optic hand drier	400
Accesoris for ham tables	293
Adapter for modular slot channel	229
Adaptors for service trolleys	312
Adjustable block for shelving support	468
Adjustable block for tube	468
Adjustable rod for hanging scales	61
American shape wing screw	70
Antiallergic polypropylene lid	417
Antibibrator cover for adjustable blocks	469
Anti-caloric glove up to 150°C	343
Anti-caloric oven glove up to 350°C	344
Anti-cut food glove	343
Anti-cut industrial glove	345
Anti-oxidation knife for vegetables	113
Antistatic 15 litres bucket with handle	390
Antistatic dustpan with foldable handle, one piece	390
Antistatic flexible dough scraper without hole	388
Antistatic hand shovel	389
Antistatic plastic spatula	388

Antistatic sweeping brush with soft bristles	388
Aqueeze bottle	146
Arcos knives	125
Ashtray - wastepaper bin	459
Ashtray for reduced spaces	461
Ashtray with support and tray for sand	459
Asparagus peeling knife	115
Assembly tool imagine	34
Automatic hand sanitizer	397
Automatic mobile sink with self-contained free standing system, cold water	219
Automatic mobile sink with self-contained free standing system, hot and cold water	220
Automatic self-contained mobile hand-sink, 2 push button for cold & hot water	177
Automatic towel dispenser	404

B

Bag holder hook	49
Bag-holder container with lid and wheels	370
Bakery spatula	114
Balanced swing top with ashtray for waste bin	460
Barbecue tongs	136
Barman table	289
Basic combinations of the imagine hanging wall shelf system	24
Basic roll-up faucet hose	264
Basic structures for imagine centre system	29
Basic structures for imagine wall-side system	28
BBQ utensil set	127
BC appetizers cover	436
BC series insect exterminators by adhesive trap	364
BC series spares for insect exterminators	367
Belt barrier post	448
Blind nut and metric threads	71
Blind nut with self-tapping screws	69
Blind nuts with hexagonal head and lock	71
Blind nuts with hexagonal head and metric threads	71
Blow knife	92
Boiling oil anti-splashing glove	343
Boning knife	124
Boning knife flexible	124
Boning knife semi-flexible	124
Boning meat knife	94
Boning Victorinox knife	123
Boot washer	386
Bottle crown cap in stainless steel	168
Bottle opener	166
Bowls	158
Bowls in transparent polycarbonate	158
Brackets	19
Brackets imagine	31
Bread combined cutting board	87
Bread cutting board	87
Bread cutting board with crumb collector	87
Bread Knife	113
Bread Knife	118
Bread Knife	121
Bread knife	125
Bridge supports with back	55

Bridge supports without back	55
Broom and stick in polypropylene for food use	388
Brush and stainless support set for toilet	393
Brush with stainless steel bristles	84
Brushes and dispenser for hands and nails washing	406
Built-in ice-cream scoop washer	410
Built-in sink series	208
Bumper bar for corner 90°	62
Butcher Victorinox	123
Butcher 's knife	124
Butter curler knife	115
Butter spatula	114

C

Cake / pizza server in stainless steel	156
Cake slicer	154
Can opener	140
Can opener	140
Canelle knife	116
Canopy for doors	455
Carcass trolley	315
Cart for racks with break	454
Carving fork	115
Carving fork EC	115
Ceiling rods	57
Ceiling rods with thread	57
Central separators	41
Central support	53
Central tables	279
Centre feed mini towel dispenser, Cloud model	404
Centre legs imagine	30
Centre preparation tables	295
Centre table with shelves	286
Centre table with tabletop shelves imagine system	36
Centre table with two shelves. Specially for cutting machines	287
Centre table with two shelves. Specially for machines	287
Centre tables with polyethylene worktop	294
Centre tables with raised edge and drain	297
Ceramic knives	118
Ceramic sharpener	129
Chamber axe with polyethylene fibre	407
Champagne cooler bucket in stainless steel	171
Champagne cooler stand	171
Change tray	424
Changing room bench	335
Changing table	396
Cheese grater	143
Cheese keepers with plastic tray	439
cheese knife	99
Cheese slicer	99
Chef wall-side table	282
Chef's knife	118
Chef's knife	119
Chef's knife	121
Chef's knife	125
Chemical protective glove	345
Chicken knife	96
Chicken scissors	128

Chlorine check	352
Chop knife	93
Chopping block specially for barbecues	76
Chopping board rack	84
Chromed pourer cap (2 pieces)	168
Chromed stopper for sparkling wine	168
Churros and cookies machine	156
Cilling rods for pipe	58
Cilling rods for pipe with thread	59
Cleaning cart	387
Clip for baking tray in stainless steel	150
Clothes stand	443
Cocktail plate	160
Cod knife	111
Coffe grounds striker kit for small drawer	465
Coffee grounds striker kit for modular drawer	300
Coin and bill tray	431
Colander	138
Colander/Chinese strainer	138
Cold meat cutter	145
Cold meat knife	99
Cold plate for dishes	162
Cold+ cold water drinking fountains	199
Column fountain - Unrefrigerated	200
Combi cutter knife Metal detectable	454
Commercial radiant heater for food warming	303
Compact roll-up faucet hose	263
Console table with two shelves	286
Container and pump-dispenser set for sauce	147
Container for knives transport	133
Container for knives transport with wheels	133
Container with lid and wheels 70l	371
Containers in polypropylene	418
Cook case	135
Corer	116
Corkscrew	166
Corkscrew pocketknife	166
Corner section for modular slot channel	229
Corner separators	41
Cornering knife	94
Counter top display	437
Counter-balanced boning knife	126
Counter-balanced chef´s knife	126
Counter-balanced knives	126
Counter-balanced multi-purpose and peeling knife	126
Counter-balanced santoku knife	126
Counter-top store display showcase	438
Coupled wheels	467
Cover for stackable closed deck europallet	451
Cow skinning knife	94
Cracker hammer seafood set	159
Crochets forgés modèle à patte d´ancrage	44
Cup dispenser	304
Cup dispenser	433
Cupboards with hinged doors	306
Cupboards with sliding doors	306
Cups rack	433
Curved cornering knife	94

Curved ham knife	108
Custom fibres	81
Cutlery basket	430
Cutlery holder	430
Cutlery rack GN 1/1 - Grey	431
Cutting board scraper	85
Cutting board/fiber shovel	86

D

Dagger	97
Dagger	113
Dagger	118
Deck mounted double inlet shower fitting, 1/4 turn	238
Decorating knife	116
Decorating knife for fruits	116
Decorating set	117
Deglon Meeting knife set 3 pc	120
Design model wastepaper bin	378
Desktop wrapping machine	442
Detachable multi-purpose scissors	128
Detachable spout for shower fitting	257
DetectoGrip, detectable series	124
DetectoSteel Hyper drill	131
Diamond sharpener	129
Dishwasher plate rack basket	429
Dishwasher rack for glasses	430
Dispenser for rolls of toilet paper	402
Dispenser for rolls of wrapping material	382
Display counter for fruits and vegetables	327
Display wet floor	387
Displays stages	434
Disposable blue vinyl glove	344
Divider for vegetable / fish counter	329
Dividers for lockers	334
Dividing section for Gastronorm trays	420
Dome cover for Gastronorm container 1/1	437
Domestic model double inlet one handle table shower fitting	246
Domestic shower fitting with head	242
Door	465
Double blunt rod hooks "S" and "J" type	47
Double bowl wall-mounted hand wash basin-sink	190
Double hollowing-out knife	116
Double inlet ¼ turn model wall tap	251
Double inlet 1/4 turn wall tap	251
Double inlet 1/4 turn wall-mounted shower fitting	236
Double inlet column tap with insulated head	253
Double inlet one handle adjustable column tap	254
Double inlet one handle table inox shower fitting elbow operation	240
Double inlet one handle table shower fitting elbow operation	237
Double inlet one handle table shower fitting elbow operation	240
Double inlet one handle table shower fitting elbow operation without wall rod	241
Double inlet one handle tap elbow fonctionning, extending shower	246
Double inlet one handle tap elbow funtioning	247
Double inlet one handle wall tap elbow functioning	252
Double inlet one handle wall tap elbow fonctionning, low profile monoblock model	252
Double inlet rotating column tap with insulated head	253
Double inlet rotating mixer tap	247

Double inlet rotating tap	248
Double inlet Shower tap lift up model	243
Double inlet shower tap with spout, lift-up model	243
Double inlet table 1/4 turn shower fitting	239
Double inlet table shower fitting	234
Double inlet table shower fitting wall mounted	235
Double inlet table tap with insulating head	253
Double inlet tap timer	267
Double push buttons hand washbasin, cold and hot water	181
Double sausage hooks	51
Double tank wall-mounted hand wash basin-sink - XS model	190
Double tap hand wash basin XS model	186
Drain for pots	255
Drainer channel trap	227
Drawer assembled to shelf 2/1 imagine	33
Drawer or hopper coupled	464
Drawer or hopper coupled to shelves	463
Drawer or hopper designed to be coupled by te user	464
Drawer or hopper designed to be coupled to shelves by te user	463
Drawers	462
Drinking fountains Futura, for cold, hot and room temperature water	198
Dustpan with metal handle	390

E

Ear protection	346
Easy Trap insect trap	363
Eco serie paper or film roll holder kit	382
Electric corkscrew	167
Electronic battery working kit for washbasins and sinks	256
Electrical Integral hand wash basin with removable door	183
Electrical Wall-mounted integral hand wash basin	189
Electronically operated tap timer for urinals	260
Electronically-operated hot and cold-water column hand wash basin	179
Electronically-operated hot and cold-water hand wash basins	183
Electronically-operated hot and cold-water wall-mounted hand wash basins	185
Electronically-operated hot and cold-water wall-mounted hand wash basins	189
Electronically-operated mono block tap with temperature selector. Battery operated	256
Electronically-operated wall mounted hand wash basin with temperature selector	185
Electronically-operated wall tap	256
Elevated monoblock model double inlet one handle wall tap elbow functioning	252
Elevated straight spout one-handle tap	249
Elevation kit	78
Euronorm tray trolley	315
Expert Clinic tap	256
Express coffee pot	171
Extending tablemat	165
Extra floor grid with grating	226
Extra low double inlet basic shower fitting with spout	242
Extra low double inlet shower fitting	241
Extra low double inlet shower fitting with spout	241

F

Faux leather apron	342
Ferrule knife for parma ham	108
Fibre brackets	82

Fibre chopping block, GE series	76
Fibre chopping blocks with fringe	75
Fibre sheets	81
Fibre weighted chopping blocks	75
Fibre with interchangeable colour set	86
Filet flattener	117
Filet knife	93
Fillet knife	122
Firefighter axe with polyethylene fibre	407
Fish counter	319
Fish counter, modular extension	319
Fish fillet knife	125
Fish knife	110
Fish knife	111
Fish pliers	164
Fish preparation table with polyethylene worktop	324
Fish scissors	128
Fixed and revolving hook bracket	52
Fixed and revolving hook bracket for scales	52
Fixed spout	257
Fixed wall shelves	14
Flexible filleting Victorinox knife	123
Floor shelves	19
Floor slat ramp	451
Floor supports	62
Floor-mounted ashtray for reduced spaces	460
Floor-mounted fish counter	318
Floor-mounted hinged support bar	385
Floor-mounted sink units	214
Floor-mounted vegetable counter	328
Foam gel dispenser	398
Foldable food basket	427
Food baskets	427
Food paper wall dispenser	381
Food tubs	391
Food tubs lid	391
Food warmer lamp	303
Forged cooking model	112
Forged shellfish cracker	165
French knife with injected handle Adherent +	96
Fruit preparation centering accessory	85
Frying tongs	136
Funnel	146

G

Galvanized plug for roof seesaw model	70
Galvanized splayed rod clamp	60
Garlic press	143
Gastronom container for thermic isolation	420
Gastronom containers for allergen marking	417
Gastronom containers high temperatures	416
Gastronom containers in polycarbonate	414
Gastronom form fitting seal lids	413
Gastronom grilles	419
Gastronom trolleys	314
German manufacturing knives	122
Glass washer brush	434
Glove for fishmongers	343

Gloves dispenser	380
Gloves for extreme cold in leather - Temperatures below -20°C	344
Gloves for extreme cold in PVC - Temperatures below -20°C	344
GN fibres	83
Grater	115
Grease traps	230

H

Ham boning gouge	108
Ham boning knife	109
Ham holder RT	64
Ham holder tool	64
Ham hook for plate	48
Ham knife	121
Ham knife	122
Ham knife fluted blade, round tip	108
Ham slicing set	107
Ham support	103
Ham table RT-2D	105
Ham table RT-3D	105
Ham tong	109
Hand wash basin wall-mounted XS model knee push button	184
Hand wash basin XS model with removable door	179
Handle-holder kit	444
Handle-operated hot and cold water wall-mounted hand wash basin	184
Hands-free soap dispenser (battery working)	399
Hanging bag dispenser	381
Hanging wall shelves	16
Heater dishes for desktop shelves	303
Heavy duty hygienic Euro pallet	452
Herb mill	143
H-H-H ½" hot and cold water mixer pedal with blocking lever	258
High neck double inlet one handle shower fitting, elbow operation	237
Hygienic bags dispenser	403
Hinged brackets for wall shelves with brackets	56
Hinged hopper for coffee grounds	465
Hinged seat	385
Holster for 7 cooking tools	135
hooks	49
Horizontal wall-side handrail support bar	385
Horizontal wall-side support bar	385
Hot plate spatula	114
Hot plate spatula	114
Hot water knifeholder disinfectant for mounting	355

I

Ice cream bowl	411
Ice cream container	410
Ice crusher	145
Ice shovel	326
Ice spade	326
Ice tongs	170
Imagine adjustable wall shelves	15
Imagine shelf perforation for waste chutes	32
Individual hanger	395
Induction container	421

Industrial bucket in stainless steel	391
Industrial can opener	141
Industrial roll dispenser	405
Industrial roll wall-dispenser	405
Injected ozone generators for the interior of cold chambers and for indoor atmospheres	353
Inox center table with translucent glass worktop	290
Inox price-holder rod	440
Inox price-holder rod	440
Inox shower tray	394
Inox squat toilet	393
Inox stairs	450
Inox urinals	392
Inox wastepaper bin 70 litres, front opening	376
Inox WC pan	393
Instant water heater	192
Insulated thermal pizza delivery bag	153
Integral washbasin with removable door foot push button	180
Iron fasteners for rod	60
Isothermal food container	421

J

Julienne-mill	144
---------------	-----

K

Kebab sticks	157
Kitchen / fish scissors with protection	128
Kitchen Digital timer	352
Kitchen island with granite worktop	290
Kitchen island with wooden worktop	290
Kitchen knife	125
Kitchen model	112
Kitchen scales	148
Kitchen scales slim design	149
Kitchen timer	352
Kitchenware	136
Knee-operated hot and cold-water hand wash basins	181
Knee-operated hot and cold-water wall mounted hand wash basin RC model	187
Knee-operated hot and cold-water wall-mounted hand wash basins	187
Knife for parma ham	108
Knives with nonstick coating ILAFLOX RESIST™	121

L

Ladle	137
Lamb rod hook	45
Laquer shower tray	394
Large capacity double sink units	221
Large capacity single sink units	221
Layer cake slicer for cakes 26/28 cms	154
Leather industrial glove	345
LED blackboard with easel	439
Left corner cabinet with hinged doors	307
Left-shopping - Lockers	457
Left-shopping trolleys	456
Left-trolleys with locker	456
Leg peeling knife	96
Lid and pump-dispenser for sauce with bucket	148

Lid cover for racks	430
Lid for cutlery rack GN 1/1	431
Lid for Gastronorm containers	413
Lid for rings for waste chutes	470
Lid for stackable food box	428
Lids for containers in polypropylene	418
Lids for Gastronorm containers high temperatures	416
Lids for Gastronorm containers in polycarbonate	415
Lift block for fibres	85
Lockers 1, 2 and 3 doors	332
Lockers 2, 4 and 6 doors	333
Lockers. 1, 2 and 3 doors	324
Long handle stainless dustpan	389
Long-reach shower	261
Low profile double inlet shower fitting	242
Low profile rotating spout	257
Low profile spout model double inlet rotating tap	250
Lower crossbars imagine	30

M

Magnetic knife holder in Stainless steel	135
Magnetic wall knife holder	134
Mailbox stainless steel Premium	455
Mailbox stainless steel Premium-maxi	455
Manual knife-sharpener for worktop	130
Manual knife-sharpener for worktop - black/grey	130
Manual knife-sharpener for worktop - black/red	130
Market basket	429
Measuring jug 1 liter with non-slip bottom	156
Meat pounder with round handle	117
Meat tongs	109
Medicine chest	387
Melamine ashtray "Lucky"	461
Metal detectable safety cutter knife	454
M-F-M 1/2" no-return mixing valve	259
Mincer	144
Mincing hammer	88
M-M 1/2" push-button not timer	258
M-M 1/2" single inlet water pedal	258
M-M-M 1/2" hot and cold-water mixer pedal	258
M-M-M 1/2" thermostatic mixing valve	259
Mobile and autonomous hand wash basin high flow	176
Mobile and autonomous hand wash basins hot water accesories	178
Mobile and autonomous hand washbasin	176
Mobile and autonomous sink 1 tank and drain board	218
Mobile hand washbasin with self-contained free standing system for large events	192
Mobile sale point of hams	106
Model "C" rod hook	48
Model "J" revolving hook	50
Model "J" rod hook with fringe	44
Model "S" revolving hook	50
Modular lid for island site freezers	436
Modular multifunction boxes	33
Modular shelving with non-perforated 0,8 mm shelves	9
Modular shelving with non-perforated 1,5 mm shelves	9
Monoblock model double inlet one handle tap elbow funtioning	247
Monoblock-elevado model double inlet one handle tap elbow funtioning	248

Mortar	89
Mounted knife holder with wrapping	132
MR model insect exterminator by adhesive trap	362
Multi-colander	139
Multifunctional rod hook	49
Multipurpose french knife	96
Multipurpose handheld brush, metal detectable	388
Multipurpose scissors	128

N

Nail brush for personal use	406
Narrow antistatic brush for machinery	389
NF wall mounted ashtray	461
Nitrile globes for food use	345
Non-perforated Gastronorm containers	412
Non-perforated shelves for modular shelving	10
Non-slip floor sleds	451
Non-slip Gastronorm tray 1/1	422
Non-stick aluminium tray	425
Nut and bolt for shelves	11
Nutcracker	165
Nuts with hexagonal head and metric threads	71
Nuts with hexagonal head and metric threads	71
Nylon-plastic plug	69

O

Octopus presentation plate	159
One handle column tap	254
One handle elbow functioning tap, extending shower	246
One handle mixer for bidet	266
One handle mixer for shower	267
One handle tap with low profile spout	250
One inlet basin tap	266
One push button free standing self-contained mobile electrical hand washbasin	177
One push buttons washbasin, cold and hot water	180
One-handle mixer for basin	266
One-handle mixer for bath/shower	267
Onion knife	122
Optional hot water for mobile sink	218
Oval mold burger press	98
Oval perforated serving spatula in stainless steel	152
Oval polyethylene serving board for 8 sauces	160
Oval serving spatula in stainless steel	152
Oyster opener	146
Ozone curtain especially for fishmongers	354
Ozone knifeholder disinfectant for mounting	355
Ozone sterilizing cabinet for knives	357

P

Palet for cured hams	316
Pallet for sausages and cured meat	317
Pallet truck in painted steel	453
Paper or film roll holder kit	382
Paring knife	121
Paring knife	122
Parking for shopping trolley	63
Pastry brush in silicone and stainless steel	155

Pastry making utensils	154
Pastry showcase	437
Pastry showcase - 2 displaying shelves	437
Pedal bin	377
Pedal operated folding system bag-holder container	371
Pedal operated sanitary bin	377
Pedal operated stainless container with lid	370
Pedal operated wastepaper bin with lid	378
Pedal-operated column fountain - Unrefrigerated	200
Pedal-operated hot and cold-water hand wash basins	182
Pedal-operated hot and cold-water wall-mounted hand wash basins	188
Peeler	140
Peeling	118
Peeling knife	113
Peeling knife	115
Peeling knife	119
Peeling knife	125
Pepper	142
Perforated bottom for Gastronorm containers	413
Perforated bottoms for containers in polypropylene	419
Perforated bottoms for Gastronorm containers high temperatures	416
Perforated bottoms for Gastronorm containers high temperatures	419
Perforated bottom for Gastronorm containers in polycarbonate	415
Perforated columns for plates	40
Perforated Gastronorm containers	413
Perforated pastry baking tray	426
PH check	352
Piano hinge	72
Pick and mix bin	438
Pipe at right angle	64
Pipe bridge supports with back	55
Pipe bridge supports without back	56
Pipe in "T"	64
Pipe intersections	64
Pipe straight supports	56
Pipe uprights	42
Pipes	43
Pizza aluminium tray with handgrips - 6 slices	151
Pizza aluminium tray with handle - 6 slices	151
Pizza cutter	152
Pizza dough cutter	150
Pizza dough pitter in stainless steel	150
Pizza making utensils	150
Pizza plate	159
Pizza server in stainless steel	153
Plain washer	72
Plane for fibres	84
Plastic bin with lid 55 Litre	377
Plastic bin with pedal	377
Plastic blocks for tube	469
Plastic bucket, metal detectable	390
Plastic cleaning bucket, metal handle	391
Plastic spatula, metal detectable	387
Plastic wall bumpers	67
Plate	63
Plate kit for shelves	11
Plated knife holder for mounting	134
Plates	43

Plates and glasses racks	208
Platform trolley	315
Polycarbonate cup	163
Polycarbonate glass	163
Polyethylene shelves imagine	32
Polyethylene cutting board-display for fish counter	326
Polyethylene hinged shelf for mobile sale point of hams	107
Polyethylene hinged wall shelf	20
Polyethylene mixing paddle	88
Polyethylene trowel for crushing ice	326
Portable knives holder	132
Portable ozone generator	354
Portable stainless steel knife holder	359
Preparation and cleansing tables	284
Preparation and cleansing tables	323
Preparing and serving centre table imagine	35
Pre-rinse wall-side table	285
Presentation plate	159
Presentation trays	422
Presentation trays BP1	422
Presentation trays BP2	423
Presentation trays BP3	423
Price-holder clamp for imagine	34
Price-holder imagine	34
Professional cutlery for Butchers	92
Professional food mill	144
Professional knife-sharpener	131
Professional pizza cutter	152
Professional plus roll-up faucet hose	263
Professional push-button shower set	268
Professional roll-up faucet hose	262
Professional scissors	128
Protectionmask	346
Protective glasses	346
Pulling hook	50
Push button timer for WC	260
Push-button M-M 1/2" timer	258
PVC strip curtains	456

Q

Quarter turn lever mixer tap	249
Quartering tables	298
Queuing ticket dispenser	448
Queuing ticket screen with remote controlled	448

R

Rack basket	429
Rack basket extension	429
Raised backsplash for mobile hand washbasin	178
Rectangular change tray	425
Rectangular fibre steak-boards	158
Rectangular polyethylene serving board for 4 sauces	161
Rectangular polyethylene serving board for 6 sauces	161
Rectangular wire basket	162
Recycling bin with swing lid	375
Recycling container	376
Remote controlled RF socket	367

Retractable hanger	395
Reversible five finger stainless-steel mesh gloves	341
Reversible side upstands for tables	304
Revolving sausage hook	49
Ribeye steak table knife	164
Right corner cabinet with hinged doors	307
Ring mold set	89
Rings for waste chutes	470
Rings mold set in stainless steel - 6 pieces	141
Rod cups rack	433
Rod hooks "J" shaped	46
Rod hooks "S" shaped	46
Rod mounted knife holder	134
Rod with metric threads	70
Rods for scales	61
Roll bag dispenser	381
Rolling door for waste bin	304
Rolling pin	88
Rolling platform	453
Rolling step-stool	21
Rolling step-stool	450
Roll-up shower for oven	261
Rotating glass plate	161
Rotating ham holder RT-2D	102
Rotating plate	162
Rotating spout	257
Round edged fish knife	110
Round mold burger press	98
Round plate	63
Round polyethylene serving board for 6 sauces	160
Round wire basket	162
Rounded burger press	97
Rounded tray baking peel in aluminium	151
Rounded tray baking peel in aluminium	152

Screw with allen head and metric thread	69
Screw with nut and counter nut with metric threads	70
Screws with hexagonal head	69
Screws with hexagonal head and metric threads	68
Screw-type forged hook	45
Screw-type ham hook	48
Seafood fork	165
Seafood table	325
Seafood tray	426
Sealing plug (2 pieces)	168
Self-tapping screws	69
Service trolley	311
Serving boards design for 6 sauces	161
Serving spoon	137
Serving tongs	136
Shaker	170
Sharp edged fish knife	110
Sharpener	129
Sheet-support for pots and buckets	222
Shelves, desktop	17
Shelving supports	10
Shoulder-ham holder	104
Shower for oven	261
Shower for oven, push button operation	262
Shower head	268
Side support	53
Side support for pipe	54
Sifter in stainless steel	156
Simple change tray	424
Simple shopping basket	428
Single "U"	65
Single inlet ¼ turn model table tap	244
Single inlet 1/4 turn rotating tap, elevated model	250
Single inlet 1/4 turn rotating tap, low spout	251
Single inlet adjustable column tap	254
Single inlet angled tap	251
Single inlet long-neck wall tap with insulating tap head	252
Single inlet low-neck wall tap with insulating tap head	253
Single inlet table shower fitting	232
Single inlet table shower fitting	233
Single inlet tap timer	267
Single lever table tap with elevated rotating spout	247
Single sausage hooks	51
Sink drain - Splus double model	225
Sink drain - Splus individual model	225
Sink unit with integral sump. Specially for plaster preparation	222
Sink units	206
Sink units for dishwashers	209
Sink units to weld	205
Sink units welded to tables	305
Sink units with sliding and hinged doors	216
Sink with single lever high spout	246
Sink-drain	222
Skewer holder	157
Skinning knife	95
Skinning Victorinox knife	123
Sloping inclined wall rack shelf	21
Slot channel, modular concept	228

S

S model rod hooks without point	47
Salmon Victorinox knife	123
Salt and peeper set	165
Salt shaker	142
Sanitary floor-drainer horizontal outlet	227
Sanitary floor-drainer vertical outlet	226
Sanitary work station	263
Santoku Knife	118
Santoku knife	125
Sashimi knife	119
Sauce bowl	158
Sauce pump dispenser set	147
Saucepan in stainless steel	150
Sauces dispenser	147
Sausage displays boards	54
Sausage hook with lamb hook	51
Sausage punch	145
Scale removers	111
Scale removers EC	111
Scented filter for urinals	392
Scoop	139
Scraper for glass ceramic	149

Slotted spoon	138
Slotted turner	137
Soap dish	394
Soap dispenser	398
Soap dispenser, Cloud model	398
SP model insect exterminator by adhesive trap	362
Spare accessories for dispensers	383
Spare blade for chromium spatula	149
Spare fibres for tables	82
Spare for inox-dustbin	376
Spare for insect exterminators	366
Spare masses	79
Spare pack of 6 colours	86
Spare part and complements	335
Spare part for burger press	98
Spare parts for fish counter	322
Spare parts for hand wash basins	193
Spare parts for lockers	457
Spare parts for saw	97
Spare parts for service and collection trolleys	313
Spare parts for sink units	224
Spare parts for sterilizing cabinets	360
Spare parts for taps	269
Spare parts for vertical recycling waste bin	375
Spare parts for water fountains M 3/8"	202
Spare scraper blades set for plane	85
Spare striker for coffee grounds	465
Spare wheel for step-stools	21
Spare wooden block to attach fibre on top	79
Spatula	137
Spatula for chromium plate griddles	149
Spatula for pizza in stainless steel	153
Spatula in silicone and stainless steel	155
Special height adjustable block for tube	468
Spice rack three levels	143
Splash apron	342
Spoon	160
Spoon	137
Spring action ice-cream scoop	411
Spring balancer	449
Square bend screw	70
Square pastry mould	141
Squared tray baking peel in aluminium	151
Stackable box for food use	428
Stackable closed deck europallet	451
Stainless steel wall-mounted emergency eyes-bath	386
Stainless bench for changing room with double shoe rack	335
Stainless dustpan	389
Stainless floor stand for queuing ticket dispenser	449
Stainless pizza pans	153
Stainless push-button operated hand dryer with nozzle	399
Stainless roll-up faucet hose	264
Stainless satiny optic hand drier with nozzle	400
Stainless satiny optic hand drier without nozzle	400
Stainless steel sterilisers wardrobe for tools and shoes	358
Stainless steel and nylon ice-cream scoop	411
Stainless steel and polyethylene mixing paddle	88
Stainless steel bag closer	442

Stainless steel baking tray	425
Stainless steel bucket	391
Stainless steel cleaner	470
Stainless steel container with lid	370
Stainless steel cover strip	67
Stainless steel curved corner guard	67
Stainless steel derrent spikes for pigeons	455
Stainless steel desk	310
Stainless steel dispenser for hands and nails washing-brusher	406
Stainless steel dispenser for rolls of toilet paper	402
Stainless steel double purpose one handle tap	249
Stainless steel dustbin with lid and wheels. Special for bakery	371
Stainless steel external corner guard	67
Stainless steel filter for exhaust hood	337
Stainless steel flashing for tables and sinks	305
Stainless steel foot for collective hand washbasin	192
Stainless steel grater	144
Stainless steel grommet	469
Stainless steel ice shovel	170
Stainless steel industrial hanger	334
Stainless steel industrial hanger	444
Stainless steel internal corner guard	67
Stainless steel low consumption hand drier	401
Stainless steel menu trays	423
Stainless steel mesh protective apron	342
Stainless steel mirror	396
Stainless steel omelette turn over lid	139
Stainless steel pallet truck	452
Stainless steel pictogram	445
Stainless steel presentation trays	422
Stainless steel saw	97
Stainless steel shelves imagine	32
Stainless steel skirting board	67
Stainless steel soap dispenser	399
Stainless steel soap dispenser to be embedded	399
Stainless steel spray	470
Stainless steel stool	450
Stainless steel stopper	168
Stainless steel toggling wastebin	376
Stainless steel towel dispenser	403
Stainless steel tray with handle	423
Stainless steel wall-mounted rack	443
Stainless steel waste bin for fast-food tray's emptying	299
Stainless steel waste bin for fast-food tray's emptying	372
Stainless steel wick-paper dispenser	405
Stainless steel one-handle gooseneck table tap	245
Stainless steel one-handle table tap	245
Stainless steel one-handle table tap high model	245
Stainless-steel stand for dispensers	449
Stand for coffee pot	434
Stand support for sausage cutting	287
Stand support for scales	435
Standard fibres	80
Standard forged hooks	44
Standard handle for Gastronorm containers	420
Steak table knife	164
Steel valve with cap for grease evacuation	337
Sticking knife	124

Straight section for modular slot channel	228
Straight supports	55
Straight white polyethylene fender plinth	66
Stuffing horn set in stainless steel	155
Stuffing needle	114
Sump unit for slot channel	228
Support for imagine hanging wall shelf	15
Support imagine	31
Sushi rolling mat hygienic	90

T

T mixed "U"	65
T shaped section for modular slot channel	229
Table fork	163
Table knife, smooth cut blade	164
Table spoon	164
Tap timer for urinals	260
Tap to fill up jars	259
Taps Accessories for roll-up faucets	265
Taps and shower display	244
Taps for drinking fountain	259
Temperature and humidity recorder	351
Tensor for stainless-steel mesh gloves	341
Tephri trap insect trap	363
Terrace working table	288
Thermometers	347
Thermos flusk jug	171
Tilting rotating ham holder RT-3D	102
Tissues, towels, gloves dispenser	383
Titanium knives	119
Toilet paper dispenser, Cloud model	404
Toilet paper roll dispenser	395
Tomato knife	117
Tomato squeezer	145
Tool for mincer	89
Tool for strainer	89
Tool-holder kit	52
Tool-holder kit imagine	33
Tote bin for lift	314
Towel bar	394
Towel dispenser, Cloud model	404
Towel shelf	395
Towels dispenser	403
Transparent front panel for imagine	34
Trap for modular slot channel	229
Trays for beer	424
Triangle	90
Triple dispenser for toilet paper	403
Trolley for drums and barrels	454
Trolley for ice transportation	313
Trolley for ice transportation	314
Trolley, collection	312
Tube wall shelves	14
Tubular rivets	72
Twin pedal-operated hot and cold-water hand wash basins	182
Twin pedal-operated hot and cold-water wall-mounted hand wash basins	188
Twist waste handle tap M-M 1/2"	258

Two mandle cold meat knife	99
----------------------------	----

U

U in T	65
U in double T	65
U.V. Knives disinfectant cabinets	356
U-bended drain with horizontal outlet	226
U-bended drein with vertical outlet	226
U-bended floor grid with grating	227
UK-INOX model insect exterminator by electric grill	361
UL model insect exterminator by adhesive trap	361
Ultra-fast hand drier	401
Ultra-fast optic hand drier Jet-01	401
Umbrella stand	443
Under worktop roll-up shower for oven	262
Universal cup dispenser	432
Universal knife	122
Upper crossbars imagine	31
Utility	118

V

Vacuum packaging machine	441
Vacuum Packaging Rolls	441
Vegetable counter to be fitted on a built-in stand	329
Vegetable drainer	139
Vegetable knife	119
Vegetable knife	125
Vegetable plate	117
Vegetable preparation table	283
Vertical recycling waste bin	374
Vertical wall-side hinged support bar	384
Vertical wall-side support bar	384
Victorinox chef knife case	127
Victorinox knives	123

W

Waiter trays	424
Wall left-shopping trolleys	457
Wall mounted collective washbasins	191
Wall mounted note-holder	431
Wall mounted rack with hooks	53
Wall mounted sinks with brackets	210
Wall shelf for meat plastic trays	20
Wall shelf specially for microwaves	14
Wall shelves	18
Wall-mounted corkscrew	167
Wall-mounted corner fountain - Unrefrigerated	201
Wall-mounted corner hand wash basin XS model	186
Wall-mounted emergency shower	386
Wall-mounted forged hook	45
Wall-mounted fountain - Unrefrigerated	201
Wall-mounted ice-cream scoop washer	411
Wall-mounted integral hand wash basins knee push button	188
Wall-mounted LED blackboard	439
Wall-mounted rainfall tub shower tap set	268
Wall-mounted rotating spout	257
Wall-mounted round fountain - Unrefrigerated	201

Index analytique

Wall-mounted sink units with skirt and brackets	212
Wall-mounted stainless steel exhaust hood	337
Wall-mounted straight pipe supports	54
Wall-mounted straight supports	54
Wall-mounted rotating ham holder RT-2D	102
Wall-side legs imagine	30
Wall-side preparation tables	296
Wall-side support bar for bath	384
Wall-side support bar for washbasin	384
Wall-side table for waste chutes with sink	282
Wall-side table with superior shelves series imagine	36
Wall-side tables	279
Wall-side tables with doors	280
Wall-side tables with doors and drawers	281
Wall-side tables with drawers	285
Wall-side tables with raised edge and drain	297
Wardrobe for cleaning products	308
Wardrobe for computer equipment	310
Washing trolley with drain	313
Wastepaper bin	378
Waste and recycling chutes wall-side table	373
Waste and recycling container	373
Waste bin	368
Waste bin with lid and wheels	369
Waste chutes wall-side table	283
Waste receptacle for scraps to fix to chopping blocks	435
Wastepaper bin and paper bags dispenser	381
Water cooler	202
Water jug 1,8 l	163
Waterproof boots in PVC/Nitrile	346
Weighing hooks	68
Welded reinforcements for shelves	11
Wheel fixing kit	467
Wheels	466
Whisk	138
White polyethylene fender plinth for exterior angle	66
White polyethylene fender plinth for interior angle	66
Whole dispenser for gloves and hanging plastic bags	379
Whole dispenser for plastic bags	379
Whole gloves and plastic bags dispensers with wastebins	380
Whole gloves and plastic roll bags dispenser	379
Wick-paper dispenser	405
Wine aerator	169
Wine bottle digital thermometer	170
Wine bottle vacuum pump	169
Wine drip collar in stainless steel	169
Wine pourer	169
Wine racks	432
Wing nut american shape	72
Wire mesh baguette tray. Stainless steel	426
Wooden and fibre chopping blocks, with fringe	77
Wooden chopping blocks with fringe	77
Worktop and wall fixed Gastronorm trays holder	13
Worktop knife holder with dual housing	133

A

Accessoire de préparation pour centrage de fruit	85
Accessoires de rechange pour dispensateurs	383
Accessoires pour lave-mains sur pied autonome et portable	178
Accessoires pour tabls porte-jambon	293
Accroche-coupes	433
Accroche-coupes à tige	433
Adaptateur pour canal modulaire avec rainures	229
Adaptateurs pour chariots de service	312
Affiche sol humide	387
Aiguille lardoire	114
Aiguiseur de couteau manuel sur table rouge/noir	130
Aiguiseur de Couteaux manuel sur table gris/noir	130
Aiguiseur manuel sur table	130
Aiguiseur professionnel	131
Anneau de chute acier inox anti-gouttes pour bouteille de vin	169
Aplatisseur ronde	117
Appareil à churros et pâtisserie	156
Ardoise lumineuse LED murale	439
Armoire à épices	143
Armoire à pharmacie	387
Armoire d'angle à droite avec portes ouvrantes	307
Armoire d'angle à gauche avec portes ouvrantes	307
Armoire inoxydable pour la stérilisation des outils et des chaussures	358
Armoire pour produits d'entretien	308
Armoire pour vestiaire de 1, 2 et 3 portes	324
Armoire pour vestiaire de 1, 2 et 3 portes	332
Armoire pour vestiaire de 2, 4 et 6 portes	333
Armoire rayonnage de 2 portes	309
Armoire stérilisateur de couteaux à l'ozone	357
Armoires à portes coulissantes	306
Armoires à portes ouvrantes	306
Armoires désinfectants de couteaux	356
Assiette de cocktail	160
Assiette de pizza	159
Assiette de présentation	159
Assiette de présentation poulpe	159
Assiette en verre tournante	161
Assiette tournante	162
Auvent pour portes	455

B

Bac à crème glacée	410
Bac d'induction	421
Bac en polypropylène antiallergique	417
Bac Gastronorm antidérapant 1/1	422
Bac Gastronorm d'isolation thermique	420
Bacs en polypropylène	418
Bacs Gastronorm en polycarbonate	414
Bacs Gastronorm hautes températures	416
Bacs Gastronorm lisses	412
Bacs Gastronorm perforé	413
Baguette d'angle en acier inoxydable courbe	67
Baguette d'angle externe en acier inoxydable	67
Baguette d'angle interne en acier inoxydable	67

Z

Zinc-plated thick iron rods and metric threads	53
--	----

Balai et manche en polypropylène pour usage alimentaire	388
Balance de cuisine ultra-fine	149
Balance mécanique de cuisine	148
Banc pour vestiaire	335
Banc range chaussures inoxydable de vestiaire 2 niveaux	335
Bande chauffante pour étagères à poser sur table	303
Baquets rons aliments	391
Barman tableau	289
Barre d'appui murale horizontale	385
Barre d'appui murale horizontale main courante	385
Barre d'appui murale pour bainoire	384
Barre d'appui murale pour lavabo	384
Barre d'appui murale verticale	384
Barre d'appui murale verticale battante	384
Barre d'appui battante ancrage au sol	385
Barre de seuil en acier inoxydable	67
Barre dents de loup	53
Barre porte serviette	394
Barre pour petit tiroir de marc à café	465
Base anti-vibrateur pour taquets réglables	469
Base inox pour transport de pizzas	153
Biberons de cuisine	146
Billot modèle GE	76
Billot special pour barbecues	76
Billots en bois avec pan	77
Billots en bois et en fibre avec pan	77
Billots en fibre avec support à pan	75
Billots lestés en fibre	75
Bloc de bois de rechange pour accoupler fibre superposée	79
Blocs de rechange	79
Boîte alimentaire empilable	428
Bol à sauce	158
Bols	158
Bonde Splus modèle double	225
Bonde Splus modèle simple	225
Books modulaires multifonction	33
Bottes pluie en PVC / Nitrile	346
Bouche d'égout extra bas	226
Boucher Victorinox	123
Bouches avec siphon de sortie horizontale	226
Bouches avec siphon de sortie horizontale	227
Bouches avec siphon de sortie verticale	226
Bouchon hermétique acier inox (2 pièces)	168
Bouchon inox	168
Bouchon pour bouteille de champagne chromé B	168
Bouchon verseur chromé (2 pièces)	168
Boulier à glace	411
Bouton-poussoir temporisé M-M 1/2"	258
Bouton-poussoir non temporisé M-M 1/2"	258
Bowl pour crème glacée	411
Bowls en polycarbonate transparent	158
Brochette	157
Brosse à balai antistatique doux	388
Brosse à main multi usage métal détectable	388
Brosse à ongles pour usage personnel	406
Brosse antistatique étroite pour machines	389
Brosse d'acier inoxydable	84
Brosse et support inoxydable pour bains	393

Brosse pour lave-verres	434
Broyeur à glace	145
Butée pour fibres	82

C

Cabinet pour matériel informatique	310
Cafetière express inox	171
Caillebotis anti-dérapant	451
Cale pour plaque de découpe	85
Canal égout	227
Capsule couronne acier inox	168
Casier de rangement	438
Casiers - Consigne	457
Casse-noix	165
Cendrier - poubelle inox	459
Cendrier avec support et plateau pour sable	459
Cendrier en mélamine "Lucky"	461
Cendrier inox pour espaces réduits	461
Cendrier inox pour espaces réduits sur pied	460
Cendrier mural NF	461
Centre de recyclage de quatre éléments	373
Cercle carre pour pâtisserie	141
Cercles pour trémies à déchets	470
Charcuterie deux manches	99
Charcuterie	99
Chariot à carcasses	315
Chariot à lavage avec écoulement	313
Chariot à plate-forme	315
Chariot baignoire pour élévateur	314
Chariot de ramassage	312
Chariot de service	311
Chariot pour plateaux Euronorm	315
Chariots Gastronom	314
Charnière de piano	72
Charriot pour transport de barils	454
Chauffe-eau instantané	192
Check pour chlore	352
Check pour PH	352
Chevalet ardoise lumineuse LED	439
Cheville en plastic-nylon	69
Cheville galvanisé pour toit modèle balancier	70
Cintre industrielle en acier inoxydable	334
Cintre industrielle en acier inoxydable	444
Ciseaux à poisson	128
Ciseaux à poulets	128
Ciseaux de poissonniers / de cuisine avec protection	128
Ciseaux multi-usages	128
Ciseaux multi-usages démontables	128
Ciseaux professionnelles	128
Cloches à fromage base en plastique	439
Colonne de signalisation avec bande	448
Colonnes perforées pour platine	40
Colonnes pour tubes	42
Combinaisons basiques du système murale suspendue imagine	24
Compositio basiques système imagine central	29
Compositio basiques système imagine mural	28
Comptoir fruits et légumes	328
Comptoir fruits et légumes de chantier	329

Conjoint dispensateur de gants et sacs en roulot	379
Conjoint dispensateur de gants et sacs suspendus	379
Conjoint dispensateur de sacs	379
Conjoints dispensateurs de gants et sacs avec conteneurs	380
Connectez avec télécommande	367
Consigne mural pour caddies	457
Consigne pour caddies	456
Consigne pour caddies avec casier	456
Console murale battante en polyéthylène	20
Consoles battante pour d'étagères murale	56
Consoles imagine	31
Conteneur 55 lts	377
Conteneur à ordures	313
Conteneur à ordures	314
Conteneur à ordures	368
Conteneur à ordures avec couvercle et roulettes	369
Conteneur à ordures et recyclage	373
Conteneur basculant en acier inox	376
Conteneur de recyclage vertical	374
Conteneur inoxydable avec couvercle	370
Conteneur inoxydable avec couvercle à pédale	370
Conteneur porte-sacs avec couvercle et rouelles	370
Conteneur porte-sacs système pliant pédale	371
Conteneur pour déplacer les couteaux	133
Conteneur pour déplacer les couteaux avec des roues	133
Coquilleur à beurre	115
Corbeille à papiers et distributeur de sacs en papier	381
Corbeille à papier inox 70 litres, ouverture frontale	376
Corbeille à papiers	378
Corbeille à papiers avec couvercle et pédale	378
Corbeille à papiers modèle Dèsign	378
Cornet	139
Coteau à poisson	111
Couillère	160
Coupe pâte à pizza	150
Coupe pizza professionnel	152
Couperet à frapper	92
Couperet cotelettes	93
Couperet d'office	96
Couperet-steak	93
Couteau à décorer	116
Couteau à découper	124
Couteau à désosse Victorinox	123
Couteau à dessoser contrebalancé	126
Couteau à filet flexible Victorinox	123
Couteau à fromage	99
Couteau à jambon	121
Couteau à jambon	122
Couteau à jambon courbe	108
Couteau à jambon de montagne	108
Couteau à jambon de montagne à virole	108
Couteau à légumes	119
Couteau à morue	111
Couteau à pain	113
Couteau à pain	118
Couteau à pain	121
Couteau à pain	125
Couteau à pizza	152

Couteau à poisson	110
Couteau à poisson à pointe fine	110
Couteau à poisson à pointe ronde	110
Couteau à poulets	96
Couteau à saigner	124
Couteau à saumon Victorinox	123
Couteau à tomate	117
Couteau à vider double	116
Couteau alvéolé pour jambon de pays avec pointe ronde	108
Couteau antioxydant pour légumes	113
Couteau carottier	116
Couteau Chef	118
Couteau Chef	119
Couteau de chef contrebalancé	126
Couteau de cuisine	121
Couteau de table bord lisse	164
Couteau de table modèle pour côtelette	164
Couteau de table modèle pour steak	164
Couteau décorateur de fruit	116
Couteau d'office	121
Couteau d'office	122
Couteau français injecté Adherent +	96
Couteau multi-usage et éplucheur contrebalancé	126
Couteau oignon	122
Couteau pour coins	94
Couteau pour coins courbé	94
Couteau Santoku	118
Couteau Santoku	125
Couteau Santoku contrebalancé	126
Couteau Sashimi	119
Couteau universel	122
Couteaux à revêtement antiadhésif ILAFLON TM RESIST™	121
Couteaux Arcos	125
Couteaux contrebalancés	126
Couteaux de fabrication allemande	122
Couteaux en céramique	118
Couteaux titane	119
Couteaux Victorinox	123
Coutellerie professionnelle pour bouchers	92
Couvercle basculement pour bac gastro 1/1	437
Couvercle doseur de sauce avec seau	148
Couvercle en polypropylène antiallergique	417
Couvercle hermétique pour bacs Gastronom	413
Couvercle inox basculant avec cendrier pour poubelle	460
Couvercle pour bacs Gastronom	413
Couvercle pour bacs Gastronom en polycarbonate	415
Couvercle pour bacs Gastronom hautes températures	416
Couvercle pour bassine	391
Couvercle pour boîte alimentaire empilable	428
Couvercle pour boîte alimentaire empilable	430
Couvercle pour canal modulaire avec rainures	229
Couvercle pour cercle pour trémies à déchets	470
Couvercle pour Euro palette emboitable à plateau plein	451
Couvercle pour Range-couverts gris Gn 1/1	431
Couvercle retourne-omelette inox	139
Couvercles en polypropylène GN plusieurs couleurs	419
Couvercles pour bacs en polypropylène	418
Couverts panier	430

Couvre-joint pour union de tables et éviers	305
Crochet à 3 griffes	49
Crochet à barre multifonctionnel	49
Crochet à tige modèle "C"	48
Crochet à tige modèle agneau	45
Crochet console fixe et giratoire	52
Crochet console fixe et giratoire pour balances	52
Crochet d'arrêt pour visser	48
Crochet d'entraînement	50
Crochet de charcuterie à griffe pour agneau	51
Crochet tournant de charcuterie	49
Crochet tournant modèle "J"	50
Crochet tournant modèle "S"	50
Crochets à jambon pour barre	48
Crochets à tige modèle "J"	46
Crochets à tige modèle "J" avec patte d'ancrage	44
Crochets à tige modèle "S"	46
Crochets à tige modèle "S" sans pointe	47
Crochets de charcuterie double	51
Crochets de charcuterie simple	51
Crochets en forme de tige "S" et "J" doubles sans pointe	47
Crochets forgé modèle normal	44
Crochets forgé modèle pour sceller	45
Crochets forgé modèle pour visser	45
Crochets pour accrocher des sacs	49
Crochetspeseurs	68
Cuillère	137
Cuillère à crème glacée avec lame intérieur	411
Cuillère à sauce en acier inox	150
Cuillère à servir	137
Cuillère à soupe	164
Cutter avec métal détectable combi	454
Cutter de sécurité avec métal détectable	454
Cuvette WC inox	393

D

Décor set	117
Deglon Meeting set de couteaux 3 pc	120
Der rostfreie premium Briefkasten	455
Der rostfreie premium-maxi Briefkasten	455
Désinfecteur automatique de mains	397
Désosseur	94
Désosseur	124
Désosseur flexible	124
Désosseur jambon	109
Désosseur semi-flexible	124
Dessous de plat extensible	165
Dessus vitré pour congélateurs libre-service	436
DetectoGrip, Série détectable	124
DetectoSteel Hyper drill	131
Dévidoir de papier hygiénique triple	403
Dévidoirs de rouleaux de papier hygiénique	402
Dévidoirs de rouleaux de papier hygiénique en acier inoxydable	402
Dévidoirs de rouleaux pour protéger les aliments	382
Dispensateur d'essuie-mains	403
Dispensateur de papier-mèche	405
Dispensateur de papier-mèche en acier inoxydable	405
Dispensateur de tissus, essuie-mains, gants, etc.	383

Dispensateur en acier inoxydable d'essuie-mains	403
Dispensateur et brosse pour le lavage des mains et ongles	406
Dispensateur inoxydable de brosses à mains et ongles	406
Dispensateur mural de papier alimentaire	381
Dispositif de remplacement pour faire tomber le marc de café	465
Distributeur automatique de serviettes	404
Distributeur de bobine industrielle	405
Distributeur de gants	380
Distributeur de papier cheminé modèle nuage	404
Distributeur de papier essuie-mains modèle nuage	404
Distributeur de papier toilette modèle nuage	404
Distributeur de sacs hygiéniques	403
Distributeur de sacs sur rouleau	381
Distributeur de sacs suspendus	381
Distributeur de sauce avec 2 pompes	147
Distributeur de sauces	147
Distributeur de savon modèle nuage	398
Distributeur de tickets file d'attente	448
Distributeur de verres	304
Distributeur de verres	433
Distributeur mural de bobine industrielle	405
Distributeur papier hygiénique	395
Distributeur universel de gobelets	432
Diviseur pour armoire vestiaire	334
Doseur de savon	398
Doseur de savon automatique (à piles)	399
Doseur de savon en acier inoxydable	399
Doseur de savon en acier inoxydable pour adosser	399
Doseur pour gel à mousse	398
Dosseret inox postérieur pour lave-mains autonome	178
Dosseret latéral réversible pour tables	304
Douche à grande portée	261
Douche d'urgence murale	386
Douche enroulable sous plan pour four	262
Douche pour four	261
Douche pour four enroulable	261
Douche pour four, fonctionnement à poussoir	262
Drainage pour marmites	255

E

Eau chaude optionnelle pour plonge autonome	218
Ecailleurs	111
Ecailleurs EC	111
Échelones	434
Ecorcheur	95
Ecorcheur boeuf	94
Écorcheur Victorinox	123
Écran pour file d'attente avec commandé	448
Ecrase-steak	117
Ecrou à oreilles	72
Ecrou de trou borgne à filetage métrique	71
Ecrou de trou borgne à vis à bois	69
Ecrous borgne hexagonale à filetage métrique	71
Ecrous borgne hexagonale avec auto-sécurité	71
Ecrous hexagonale à filetage métrique	71
Ecrous hexagonale à filetage métrique autobloquant	71
Écumoire	138
Égout canal modulaire avec rainures	228

Égout sanitaire sortie horizontal	227
Égout sanitaire sortie vertical	226
Égouttoir légumes	139
Égouttoirs pour assiettes et verres	208
Enregistreur de température et humidité	351
Enrouleur de maki hygiénique	90
Ensemble de distributeur-doseur de sauces et récipient inoxydable	147
Ensemble douche bouton-poussoir professionnelle	268
Ensemble robinet douche mitigeur fixation mural	268
Entonnoir	146
Éplucheur	115
Éplucheur	118
Éplucheur	119
Éplucheur	125
Éplucheur	140
Éplucheur	113
Éplucheur d'asperges	115
Éponges pour plaque de coupe	85
Équères	19
Équilibrateur	449
Espray acier inoxydable	470
Étagère murale inclinée pour paniers de lavage	21
Étagère murale porte-barquettes alimentaires	20
Étagère murale spéciale micro ondes	14
Étagère ouvrante en fibre pour point de vente de jambon portable	107
Étagères à poser sur table	17
Étagères au sol	19
Étagères en acier inoxydable imagine	32
Étagères en polyéthylène imagine	32
Étagères lisses pour rayonnages modulaires	10
Étagères murale consoles modèle compact	14
Étagères murales consoles en tube	14
Étagères murales réglables imagine	15
Étagères sur mur	18
Étagères suspendues	16
Étal à poisson	319
Étal à poisson avec support	318
Étal à poisson, extension	319
Euro palette emboitable à plateau plein	451
Euro palette hygiénique renforcé	452
Évier avec bouche intégré. Spécial pour le préparation des plâtres	222
Évier lave-mains suspendu à deux bacs	190
Évier lave-mains suspendu à deux bacs XS	190
Évier soudés aux tables	305
Éviers	206
Éviers à grande capacité deux bacs	221
Éviers à grande capacité un bac	221
Éviers à portes coulissantes et à portes à deux battants	216
Éviers à souder	205
Éviers avec support	214
Éviers modèle à intégrer	208
Éviers pour lave-vaisselles	209
Éviers suspendus avec habillage et barres de fixation	212
Éviers-déversoir	222
Exposant de robinetterie	244
Extension de panier	429
Exterminateur d'insectes à grill électrique modèle UK-INOX	361
Exterminateur d'insectes à trappe adhésif modèle MR	362
Exterminateur d'insectes à trappe adhésif modèle UL	361

Exterminateur d'insectes à trappe adhésif modèle SP	362
Exterminateurs d'insectes à trappe adhésif serie BC	364

F

Fibre côtes de boeuf rectangulaires	158
Fibres de rechange pour tables	82
Fibres par plaque	81
Fibres standard	80
Fibres sur mesure	81
Fil à linge retractable	395
Filet de couteau	122
Filtre inox pour hotte de cuisine	337
Filtres parfumées pour urinoirs	392
Fixations de fer pour tringle	60
Fond pour bacs Gastronorm en polycarbonate	415
Fonds perforé pour bacs Gastronorm hautes températures	416
Fonds pour bacs en polypropylène	419
Fonds pour cuveau Gastronorm	413
Fontaine colonne - Sans réfrigération	200
Fontaine colonne avec pédale - Sans réfrigération	200
Fontaine d'eau fraîche Cold+	199
Fontaine fixation murale - Sans réfrigération	201
Fontaine mural d'angle - Sans réfrigération	201
Fontaine mural ronde - Sans réfrigération	201
Fontaines d'eau froide, chaude et à température ambiante Futura	198
Forged hook model with fringe	44
Fouet	138
Fourchette à crustacés	165
Fourchette de chef	115
Fourchette de chef EC	115
Fourchette de table	163
Français tous usages	96
Fusil à affûter	129
Fusil à aiguiser diamanté	129
Fusil à aiguiser en céramique	129

G

Gant alimentaire anti-coupure	343
Gant anti-calorique jusqu'à 150°C	343
Gant anti-coupure industriel	345
Gant anti-éclaboussures d'huile bouillant	343
Gant de protection chimique	345
Gant de vinyle bleu jetable	344
Gant industriel en cuir	345
Gant pour poissonniers	343
Gants à cinq doigts réversibles en maille d'acier inoxydable	341
Gants en nitrile pour usage alimentaire	345
Gants pour froid extrême en cuir - Températures inférieures à -20°C	344
Gants pour froid extrême en PVC - Températures inférieures à -20°C	344
Générateur d'ozone portable	354
Générateurs d'ozone injecté pour l'intérieur de chambres frigorifiques et pour atmosphères d'intérieur	353
Giratoire extra bas	257
Gond à clouer	70
Gouge à désosser jambon	108
Goujons en fer zingué à filetage métrique	53
Grattoir antistatique flexible pour surface sans trous	388
Grattoir pour vitrocéramique	149

Griffes galvanisées pour tringle	60
Grilles gastronorm	419

H

Hache de chambre avec manche en fibre	407
Hache de pompier avec manche en fibre	407
Hachoir	144
Hotte de cuisine murale en acier inoxydable	337

I

Île de cuisine inox avec plan de travail en bois	290
Île de cuisine inox avec plan de travail en granit	290
Intersections pour tube	64

J

Jet detachable pour douche	257
Jet fixe	257
Jet giratoire	257
Jet mural giratoire	257

K

Kit d'accouplement aux rouelles	467
Kit d'accessoires pour barbecue	127
Kit de barre pour vider le marc de café pour tiroir modulaire	300
Kit de platines pour rayonnages	11
Kit de porte-rouleaux du papier ou film	382
Kit de porte-rouleaux du papier ou film serie Eco	382
Kit d'élévation	78
Kit électronique pour lave-mains et éviers fonctionnement à piles	256
Kit porte-manches	444
Kit pour suspendre outils	52
Kit pour suspendre outils imagine	33

L

Lame de rechange pour racloir chromée	149
Lames de réchange pour rabot à racloir	85
Laminoir pour tartes	154
Lampe pour chauffer des plats	303
Lave bottes	386
Lave main mural modèle XS poussoir genou	184
Lave-main à actionnement par double pédale d'eau froide et chaude	182
Lave-main à actionnement par genou eau froide et chaude	181
Lave-main à actionnement par pédale d'eau froide et chaude	182
Lave-main à deux eaux modèle XS	186
Lave-main autonome et portable, 2 poussoirs d'eau froide et chaude	177
Lave-main intégral avec porte amovible	183
Lave-main intégral avec porte amovible poussoir à pied	180
Lave-main modèle XS avec porte amovible	179
Lave-main mural collectif	191
Lave-main mural d'angle modèle XS	186
Lave-main mural intégral poussoir genou	188
Lave-main sur pied autonome et portable	176
Lave-mains à actionnement électronique à eau froide et chaude	183
Lave-mains autonome électrique avec poussoir	177
Lave-mains autonome registrable portable grands événements	192
Lave-mains avec piédestal, deux poussoirs d'eau froide et chaude	181
Lave-mains avec piédestal, un poussoir d'eau froide et chaude	180

Lave-mains de colonne électronique à eau froide et chaude	179
Lave-mains électronique mural intégral	189
Lave-mains mural à actionnement par genou eau froide et chaude	187
Lave-mains mural à actionnement par genou eau froide et chaude modèle RC	187
Lave-mains mural à levier eau froide et chaude	184
Lave-mains mural avec double pédale à eau froide et chaude	188
Lave-mains mural avec pédale d'eau froide et chaude	188
Lave-mains mural électronique à eau froide et chaude	185
Lave-mains mural électronique avec sélecteur de température	185
Lave-mains mural électronique d'eau froide et chaude	189
Lave-mains sur pied autonome et portable d'grand débit	176
Laveur d'acier inoxydable	470
Lave-yeux mural d'urgence en acier inoxydable	386
Légumes	125
Louche	137
Lunettes de protection	346
Lyre pour couper le fromage	99

M

Machine à envelopper de bureau	442
Machine d'emballage sous vide	441
Malette couteaux de cuisinier Victorinox	127
Manche universal pour bacs Gastronorm	420
Marche inox	450
Marteau à viande	88
Masque de protection	346
Mélangeur baignoire	267
Mélangeur bidet	266
Mélangeur douche	267
Mélangeur évier col de cigne haut	246
Mélangeur lavabo	266
Minuterie de cuisine	352
Minuterie de cuisine digital	352
Miroir inox	396
Modèle chef	112
Modèle chef forgé	112
Modèle cuisine	125
Modèle cuisinier	125
Module d'exposition pour fruits et légumes	327
Montants inférieurs imagine	30
Montants supérieurs imagine	31
Mortier	89
Moufle anti-calorique jusqu'à 350°C	344
Moule à laminer tarte 26/28 cms	154
Moulin à herbes	143
Moulin à poivre	142
Moulin julienne	144

O

Outil de montage imagine	34
Outil perce-saucisse	145
Outil pour chinois étamine	89
Outil pour hachoir	89
Outil pour porter jambons	64
Ouvre-boite	140
Ouvre-boite	140
Ouvre-boîtes industriel	141

Ouvre-huîtres	146
Ouvreur de bouteille	166
Oxygénateur de vin	169

P

Palette gril	114
Palette pour jambons	316
Panels d'exposition pour charcuterie	54
Panier	429
Panier à nettoyage	387
Panier à provisions	429
Panier de lavage pour assiettes	429
Panier rectangulaire	162
Panier Rond	162
Panier supermarché simple	428
Paniers alimentaires	427
Paniers alimentaires pliables	427
Paniers pour verres pour lave-vaisselle	430
Panneau frontal transparent pour imagine	34
Pare-choc pour coin 90°	62
Pare-chocs mural d'angle extérieur en fibre blanche	66
Pare-chocs mural d'angle intérieur en fibre blanche	66
Pare-chocs mural en fibre blanche	66
Pare-chocs mural en plastique	67
Passe-câbles en acier inoxydable	469
Passoir	138
Passoir/Chinoise étamine	138
Passoire multiple	139
Patère individuel	395
Pédale à une eau M-M 1/2"	258
Pédale mélangeuse eau froide et chaude H-H-H 1/2" avec levier de blocage	258
Pédale mélangeuse eau froide et eau chaude M-M-M 1/2"	258
Peel inoxydable	389
Peel inoxydable avec manche	389
Pelle	137
Pelle à glaçons	326
Pelle à glaçons	326
Pelle à glaçons en acier inoxydable	170
Pelle à ramasser rabattable antistatique avec manche une pièce	390
Pelle à tarte /pizza en acier inox	156
Pelle antistatique de main	389
Pelle avec manche métallique	390
Pelle carrée en aluminium pour four	151
Pelle ovale en acier inox	152
Pelle ovale perforé en acier inox	152
Pelle pour servir pizza en acier inox	153
Pelle ronde en aluminium pour four	151
Pelle ronde en aluminium pour four	152
Perforer étagère imagine pour évacuation de déchets	32
Pichet 1,8 L	163
Pictogramme en acier inoxydable	445
Pièces de rechange pour chariots de service et ramassage	313
Pièces de rechange pour éviers	224
Pièces de rechange pour fontaines d'eau M 3/8"	202
Pièces de rechange pour lave-mains	193
Pièces de rechange pour press à hamburger	98
Pièces de rechange pour robinetterie	269
Pièces de rechange pour scie à main	97

Pièces de rechange pour conteneur de recyclage vertical	375
Pièces de rechange pour stérilisateurs	360
Pied inox pour lave-mains collectif	192
Pied inoxydable avec distributeur "votre Tour"	449
Pied pour seau à champagne	171
Pieds centraux imagine	30
Pieds mureaux imagine	30
Piège à insectes Easy Trap	363
Piège à insectes Tephri Trap	363
Pièges de graisse	230
Pince à crustacés	165
Pince à dessin porte-prix pour imagine	34
Pince à friture	136
Pince de barbecue	136
Pince saucisse	109
Pinceaux en silicone et acier inox	155
Pinces à glace	170
Pinces à servir	136
Pinces pour plaque à four en acier inox	150
Pinces pour servir le jambon	109
Pincettes à poissons	164
Pique pâte à pizza en acier inox	150
Plafond pour chauffer des plats	303
Planche à découper le pain	87
Planche à découper le pain avec ramasse-miettes	87
Planche à découper le pain combinée	87
Planche en polyéthylène à 6 sauces modèle design	161
Planche polyéthylène ovale à 8 sauces	160
Planche polyéthylène rectangulaire à 4 sauces	161
Planche polyéthylène rectangulaire à 6 sauces	161
Planche polyéthylène ronde à 6 sauces	160
Plaque à découper/pelle en fibre	86
Plaque de couleur interchangeable	86
Plaque de découpe-exposant en polyéthylène pour étal à poisson	326
Plaque de légumes	117
Plaque en aluminium avec manche pour pizza 6 portions	151
Plaque en aluminium avec poignées pour pizza 6 portions	151
Plaque pâtisseries perforée	426
Plaque ronde	63
Plaques GN	83
Plaque-support pour pots et seaux	222
Plateau à monnaie	431
Plateau à pâtisserie en acier inoxydable	425
Plateau cuisson pour baguette en fil inox	426
Plateau en acier inoxydable avec manche	423
Plateau garçon décafé spécial pour pichet de bière	424
Plateau inox pour fruits de mer	426
Plateau pour plats froids	162
Plateau repas en acier inoxydable	423
Plateaux aluminium anti-adhérent	425
Plateaux de présentation	422
Plateaux de présentation BP1	422
Plateaux de présentation BP2	423
Plateaux de présentation BP3	423
Plateaux de présentation en acier inoxydable	422
Plateaux de serveur	424
Plateaux douche inox	394
Plateaux douche laqués	394

Plate-forme pour transport de paniers de lave-vaisselle	454
Plate-forme roulante	453
Platines	43
Plinthe en acier inoxydable	67
Plonge autonome avec égouttoir	218
Plonge portable autonome eau froide	219
Plonge portable autonome eau froide et chaude	220
Plonges Inox suspendues avec équerres	210
Poignard	113
Poignard	118
Point de vente de jambon portable	106
Pomme de douche	268
Porte	465
Porte couteaux inoxydable transportable	359
Porte couteaux transportable	132
Porte Jambon de Pays	104
Porte prix imagine	34
Porte roulante pour conteneur	304
Porte savon	394
Porte-bouteilles	432
Porte-brochettes	157
Porte-couteaux avec deux logements pour placer sur table	133
Porte-couteaux de mur magnétique	134
Porte-Couteaux désinfecteur à l'ozone pour adosser	355
Porte-couteaux désinfecteur à l'eau chaude pour adosser	355
Porte-couteaux magnétique en acier inoxydable	135
Porte-couteaux plaqué pour adosser	134
Porte-couteaux pour adosser avec enveloppant	132
Porte-couteaux pour adosser sur tringle	134
Porte-couverts	430
Porte-jambon giratoire basculant RT-3D	102
Porte-jambon giratoire mural RT-2D	102
Porte-jambon giratoire RT-2D	102
Portemanteau	443
Portemanteau mural en acier inoxydable	443
Porte-notes mural	431
Porte-parapluies	443
Porte-pourboire	424
Porte-pourboire rectangulaire avec clip	425
Porte-pourboire simple	424
Porte-prix en tige inox	440
Porte-prix en tige inox	440
Poste de lavage et de désinfection	263
Poubelle avec couvercle et roulettes 70l	371
Poubelle de recyclage avec couvercle basculant	375
Poubelle en acier inoxydable spéciale snack restauration rapide	299
Poubelle en acier inoxydable spéciale snack restauration rapide	372
Poubelle en plastique avec pédale	377
Poubelle hygiénique sanitaire à pédale	377
Poubelle inoxydable avec couvercle et rouelles. Spécial pour boulangerie	371
Poubelle sale de bains	377
Press à hamburger moule ovale	98
Press à hamburger moule rond	98
Press à hamburger ronde	97
Presse tomates	145
Presse-ail	143
Presse-purée professionnel	144
Profil diviseur pour cuveaux Gastronom	420

Proignard	97
Protecteur de l'oreille	346
Pupitre en acier inoxydable	310

R

Rabot pour fibres	84
Raclette grill	114
Racloir pour plaques chromées	149
Rampe pour caillebotis	451
Range-couverts gris Gn 1/1	431
Râpe	115
Râpe à fromage	143
Râpes inox	144
Rayonnages modulaires avec étagères lisses de 0,8 mm	9
Rayonnages modulaires avec étagères lisses de 1,5 mm	9
Réchange pour caddies	457
Rechangements pour poubelles	376
Rechanges et compléments	335
Rechanges pour étals à poisson	322
Rechanges pour exterminateurs d'insectes	366
Rechanges pour exterminateurs d'insectes serie BC	367
Récipient pour le recyclage	376
Refroidisseur d'eau	202
Renfort soudés aux étagères	11
Rideau d'ozone spécial pour poissonneries	354
Rideaux à lanières en PVC	456
Rince bouliers à glace mural	411
Rince bouliers à glace pour encastrer	410
Rivetages tubulaires	72
Robinet à coude une eau	251
Robinet à levier M-M 1/2"	258
Robinet à une eau sur table modèle ¼ de tour	244
Robinet colonne 2 eaux poignée isolante	253
Robinet de mur monocommande à coude pour deux eaux	252
Robinet de mur monocommande à coude pour deux eaux modèle monoblock-elevado	252
Robinet docuhe sur table à deux eaux en acier inoxydable	240
Robinet douche à deux eaux avec jet, modèle extra-bas	242
Robinet douche à deux eaux avec jet, modèle retractable	243
Robinet douche à deux eaux avec profil bas	242
Robinet douche à deux eaux, modèle retractable	243
Robinet douche modèle domestic avec pomme de douche	242
Robinet douche mural deux eaux	235
Robinet douche sur table à deux eaux	234
Robinet douche sur table à deux eaux 1/4 de tour	239
Robinet douche sur table à deux eaux lévier à coude	237
Robinet douche sur table à deux eaux lévier à coude	240
Robinet douche sur table à deux eaux lévier à coude sans tringle au mur	241
Robinet douche sur table à deux eaux modèle domestic	246
Robinet douche sur table à une eau	232
Robinet douche sur table à une eau	233
Robinet douchette deux entrées, deux poignées 1/4 de tour	238
Robinet douchette double entrée deux eaux mélangeur à code	237
Robinet douchette mélangeur deux eaux extra-bas	241
Robinet douchette mélangeur deux eaux extra-bas avec col de cygne	241
Robinet douchette mural 1/4 tour	236
Robinet électronique au mur	256
Robinet électronique monobloc avec sélecteur de température. Fonctionnement à piles	256

Robinet électronique temporisé pour urinoirs	260
Robinet enrouleur inoxydable série compacte	263
Robinet enrouleur professionnel plus	263
Robinet Expert Clinic	256
Robinet giratoire bas ¼ de tour à deux eaux	250
Robinet giratoire deux eaux	248
Robinet giratoire deux eaux modèle 1/4 de tour	248
Robinet giratoire deux eaux modèle extra-bas	250
Robinet mélangeur sur table avec col de cygne en acier inoxydable	245
Robinet mitigeur douchette extractible.pomme longue	246
Robinet mitigeur modèle 1/4 de tour	249
Robinet mitigeur mural à coude deux eaux série monoblock-bas	252
Robinet monocommande à coude pour deux eaux	247
Robinet monocommande à coude pour deux eaux modèle monoblock	247
Robinet monocommande à coude pour deux eaux modèle monoblock-elevado	248
Robinet monocommande à coude, douche extensible	246
Robinet monocommande à double usage en acier inoxydable	249
Robinet monocommande à jet haut	249
Robinet monocommande giratoire deux eaux	247
Robinet monocommande jet bas	250
Robinet monocommande sur colonne	254
Robinet monocommande sur table avec jet giratoire élevé	247
Robinet monocommande sur table en acier inoxydable	245
Robinet monocommande sur table en acier inoxydable modèle haut	245
Robinet mural à deux eaux modèle ¼ de tour	251
Robinet mural à deux eaux modèle 1/4 de tour	251
Robinet mural à une eau avec tête isolante et mitigeur bas	253
Robinet mural à une eau avec tête isolante et mitigeur haut	252
Robinet orientable sur colonne à deux eaux	254
Robinet orientable sur colonne à une eau	254
Robinet orientable sur colonne manette isolante	253
Robinet pour lavabo à une eau	266
Robinet pour remplir pots	259
Robinet sur table à deux eaux avec tête isolante	253
Robinet temporisé à deux eaux	267
Robinet temporisé à une eau	267
Robinet temporisé pour urinoirs	260
Robinet temporisé pour WC	260
Robinet tournant 1/4 tour une eau bec de robinet bas	251
Robinet tournant 1/4 tour une eau bec de robinet haut	250
Robinets pour fontaine	259
Robinetterie Accessoires pour Robinet-tuyau d'arrosage	265
Robinet-tuyau d'arrosage enroulable basique	264
Robinet-tuyau d'arrosage enroulable inoxydable	264
Robinet-tuyau d'arrosage enroulable professionnel	262
Rondelle plate	72
Rouelle de rechange pour tabouretes	21
Rouelles	466
Rouelles accouplées	467
Rouleau	88

S

Sac Thermique pour transporter des pizzas	153
Sachet sous vide	441
Salière	142
Scelleuse des sachets en acier inoxydable	442
Scie en acier inoxydable	97

Seau à Champagne acier inox	171
Seau antistatique de 15 litres avec anse	390
Seau de ménage avec poignée métallique	391
Seau en plastique, métal détectable	390
Seau industriel en acier inoxydable	391
Seaux en acier inoxydable	391
Sèche mains inox consommation bas	401
Sèche mains optique ABS	400
Sèche mains optique inoxydable satiné avec tuyère	400
Sèche mains optique inoxydable satiné sans tuyère	400
Seche mains optique ultra-rapide Jet-01	401
Sèche-main ultra-rapide	401
Sèche-mains inox avec poussoir et tuyère	399
Sèche-mains optiqueABS sans tuyère modèle nuage	400
Séchoir charcuterie démontable en palette	317
Section en angle pour canal modulaire avec rainures	229
Section en T pour canal modulaire avec rainures	229
Sections droites pour canal modulaire avec rainures	228
Séparateur pour comptoir de Fruiterie /Poissonnerie	329
Séparateurs central	41
Séparateurs de coin	41
Set à fruits de mer	159
Set de 4 éponges de couleurs	389
Set de 6 couleurs de rechange	86
Set de 6 moules à dresser en acier inox	141
Set de 6 moules cornets pour garniture de crème en acier inox	155
Set de moules	89
Set poivrière et salière	165
Set pour couper le jambon	107
Shaker	170
Sièger abattable	385
Sole	63
Sole	125
Soupape de dégraissage en acier avec bouchon	337
Spatule à beurre	114
Spatule à gâteau	114
Spatule à mélanger en acier inoxydable et polyéthylène	88
Spatule à mélanger en polyéthylène	88
Spatule de préparation pizza en acier inox	153
Spatule en plastique antistatique	388
Spatule en silicone et acier inox	155
Spatule plastique, métal détectable, rouge	387
Spatules	137
Stand en acier inoxydable pour distributeurs	449
Stationnement pour caddies	63
Support central	53
Support de rangement de planches à découper	84
Support imagine	31
Support jambon RT	64
Support jambons	103
Support latéral	53
Support latéral pour tube	54
Support pour imagine murale suspendue	15
Support pour machine à café	434
Support sur comptoir pour balances	435
Support sur comptoir pour coupe-charcuterie	287
Support sur table et mural porte-cuveaux Gastronom	13
Supports de pont avec arrière-train	55

Supports de pont avec arrière-train pour tube	55
Supports de pont sans arrière-train	55
Supports de pont sans arrière-train pour tube	56
Supports de rayonnage	10
Supports droit	55
Supports droits en tube pour sceller	54
Supports droits pour sceller	54
Supports droits pour tube	56
Supports sur plancher	62
Système modulaire de canal avec rainures	228

T

Table à langer	396
Table centrale avec deux rayons. Special pour machines à couper	287
Table centrale avec étagères à poser sur table système imagine	36
Table centrale avec rayon	286
Table centrale avec rayon. Special pour machinerie	287
Table centrale inox avec plan de travail en verre	290
Table centrale pour préparation et service imagine	35
Table console avec deux tablettes-rayons	286
Table de préparation de légumes	283
Table de préparation de poisson dessus en polyéthylène	324
Table mural de pré lavage	285
Table murale avec étagères sur table modèle imagine	36
Table murale de chef	282
Table murale pour trémie à déchets	283
Table murale pour trémie à déchets et recyclage	373
Table murale vide déchets avec bac	282
Table porte-jambon RT-2D	105
Table porte-jambon RT-3D	105
Table pour fruits de la mer	325
Table terrasse	288
Tables centrales	279
Tables centrales avec rebord et trou d'écoulement	297
Tables centrales dessus en polyéthylène	294
Tables de découpage	298
Tables de préparation centrales	295
Tables de préparation et de lavage	284
Tables de préparation et de lavage	323
Tables de préparation murales	296
Tables murales	279
Tables murales à tiroirs	285
Tables murales avec portes	280
Tables murales avec portes et tiroirs	281
Tables murales avec rebord et trou d'écoulement	297
Tablette porte-serviettes	395
Tablier de protection en maille d'acier inoxydable	342
Tablier de protection pour les éclaboussures	342
Tablier en skay	342
Tabouret inoxydable	450
Tabouret marche - pied roulant	21
Tabouret roulant	450
Tamis en acier inox	156
Taquet réglable hauteur spéciale pour tube	468
Taquet réglable pour supports de rayonnage	468
Taquets de plastique pour tube	469
Taquets réglable pour tube	468
Tasse polycarbonate	163

Tenseur des gants maille d'acier inoxydable	341
Thermomètre digital pour bouteille de vin	170
Thermomètres	347
Thermos	171
Thermos	421
Tige anti-pigeons en acier inoxydable	455
Tige spirale à filetage métrique	70
Tire-bouchon	166
Tire-bouchon à air pour bouteille de vin	169
Tire-bouchon canif	166
Tire-bouchon électrique	167
Tire-bouchon mural	167
Tire-fond de tête hexagonale	69
Tiroir assemblé à étagère 2/1 imagine	33
Tiroir or trémie accouplé aux étagères	463
Tiroir or trémie dessiné pour être accouplé aux étagères par l'utilisateur	463
Tiroir or trémie dessiné pour être accouplé par l'utilisateur	464
Tiroir ou trémie accouplé	464
Tiroirs	462
Toilette turque inox	393
Trancheuse de charcuterie	145
Transpalette en acier inoxydable	452
Transpalette peinte	453
Trémie à un abattant pour marc de café	465
Trémie d'évacuation des déchets pour adosse à billots	435
Triangle	90
Tringle réglable pour balances suspendues	61
Tringles de plafond	57
Tringles de plafond avec filetage	57
Tringles de plafond pour tube	58
Tringles de plafond pour tube avec filetage	59
Tringles pour balances	61
Trousse de chef	135
Trousse de chef pour 7 couteaux	135
Truelle en polyéthylène pour piler la glace	326
Tube en cornière	64
Tube in "T"	64
Tubes	43

U

U dans T	65
U en double T	65
U mixte dans T	65
U simple	65
Urinoir inox	392
Ustensiles de cuisine	136
Ustensiles pour pâtisseries	154
Ustensiles pour pizzeria	150
Utilitaire	118

V

Valve mélangeuse antiretour M-H-M 1/2"	259
Valve mélangeuse thermostatique M-M-M 1/2"	259
Verre doseur avec fond antidérapant 1 litre	156
Verre polycarbonate	163
Verseur	169
Vis à écrou pour étagères	11
Vis à oreilles type américain	70

Vis avec tête allen et fillet métrique	69
Vis de tête hexagonale à filetage métrique	68
Vis filetage tôle	69
Vis perçante avec écrou et cotre-écrou à filetage métrique	70
Vitrine à tapas	437
Vitrine à tapas BC	436
Vitrine d'exposition	438
Vitrine viénoiserie	437
Vitrine viénoiserie double étage	437

Z

Zesteur canneléur

116

Solicite nuestro catálogo digital y utilízelo en sus dispositivos móviles



Request our digital catalog and use it on your mobile devices

Demandez notre catalogue numérique et utilisez-le sur vos dispositifs portables



Condiciones generales
General conditions
Conditions générales

1.0 ofertas de mercancías

- 1.1 • Todos los productos incluidos en el presente catálogo están amparados por la Normativa vigente en materia de verificación y calidad exigidas por la Normativa Estatal y Europea, dentro del ámbito de la actividad empresarial de Fricosmos, S.A.
- 1.2 • El ámbito de aplicación de las presentes condiciones generales de venta abarca toda la gama de productos que Fricosmos, S.A. ha referenciado en el presente catálogo.
- 1.3 • El comprador realizará los pedidos en los términos y condiciones expresamente publicados por Fricosmos, S.A. en el catálogo de mercancías.
- 1.4 • Fricosmos, S.A. reserva el derecho de modificar los artículos incluidos en catálogo en función de las necesidades de la producción o de la existencia en el mercado de la materia prima para su fabricación.

2.0 pedidos y presupuesto

- 2.1 • Los pedidos podrán efectuarse de forma verbal o por escrito, favoreciendo siempre la posibilidad de comprar a través de los servicios comerciales de Fricosmos, S.A.
- 2.2 • Una vez verificado el alta del cliente por parte de Fricosmos, S.A., se expedirá la oportuna carta de condiciones en la que se detallarán las condiciones comerciales que regirán desde ese momento entre ambas partes.
- 2.3 • El pedido queda condicionado a la aceptación definitiva por parte de Fricosmos, S.A.
- 2.4 • El plazo de validez de un presupuesto será de 30 días a partir de la fecha del mismo.
- 2.5 • Todos los pedidos cuya fabricación requieran una medida especial o unas características concretas por requerimiento expreso del cliente, este vendrá obligado a garantizar el 50% del precio por adelantado.
- 2.6 • La falta de pago por parte del comprador dará derecho a Fricosmos, S.A. a resolver el contrato en los términos expresamente establecidos en el artículo 1.124 del Código Civil.

3.0 plazos de entrega

- 3.1 • Quedando supeditada la mercancía incluida en el presente catálogo a un proceso de fabricación del producto solicitado por el comprador, el plazo de entrega facilitado por Fricosmos, S.A. tendrá el carácter de orientativo o aproximado en el tiempo.
- 3.2 • Fricosmos, S.A. informará puntualmente al comprador del estado de elaboración de su pedido en la cadena de producción para evitar la demora del consecuente perjuicio del cliente.
- 3.3 • Los eventuales retrasos en la entrega no podrán dar lugar a penalización alguna o indemnización por daños y perjuicios, ni facultarán al comprador para anular el pedido, siempre que sea por causa imputable al proceso de fabricación.

4.0 transporte de la mercancía

- 4.1 • La mercancía viajará siempre a portes debidos salvo pacto suscrito de forma expresa con cada uno de los clientes, que quedarán debidamente reflejados en la carta de condiciones que será expedida a tales efectos.
- 4.2 • Cuando la mercancía viaje a portes debidos por indicación expresa del cliente o por que así esté pactado en la carta de condiciones, Fricosmos, S.A. queda exonerado de las posibles taras o defectos que pudieran ser imputables al transporte de la mercancía.
- 4.3 • Cuando la mercancía viaje a portes pagados por Fricosmos, S.A., el cliente tiene que notificarle a Fricosmos, S.A. por escrito dentro de las 24 horas siguientes a la recepción de la mercancía, cualquier defecto o tara imputable a la agencia de transportes para facilitar la reclamación de la responsabilidad de acuerdo a la Ley 16/1.987 de Ordenación de los Transportes Terrestres y RD 1.111/1.990 por el que se aprueba el reglamento de la LOTT.
- 4.4 • No será admitida ninguna devolución de mercancía cuya tara o defecto sea imputable a la agencia de transporte, excepto que el cliente cumpla el siguiente requisito: Que se lo notifique a Fricosmos, S.A. y/o a la Agencia de Transportes dentro de las 24 horas siguientes a la recepción de la mercancía o en el plazo legalmente establecido en cada momento en la Ley de Ordenación de Transportes Terrestres.
- 4.5 • La reclamación contra el porteador por daño o avería, deberá hacerse en el acto del recibo de los bultos siempre que se trate de daños aparentes y dentro de las 24 horas siguientes al recibo, si los daños fuesen no aparentes. La protesta o reserva debe hacerse por escrito.

5.0 entrega de mercancías

- 5.1 • La relación contractual quedará perfeccionada cuando Fricosmos, S.A. entregue la mercancía al comprador a través del medio de transporte pactado en la carta de condiciones y el vendedor firme previa revisión de la mercancía, el albarán o nota de entrega.
- 5.2 • Rehusando el comprador sin causa justa, el recibo de los bienes comprados, Fricosmos, S.A. podrá pedir el cumplimiento o la rescisión del contrato, siendo los gastos originados de cuenta de quien hubiere dado motivo para constituirlo.

6.0 precios y forma de pago

- 6.1 • Los precios de los productos ofertados por FRICOSMOS, S.A. dentro del ámbito de su actividad empresarial, son los contenidos en la tarifa vigente publicada en catálogo.
- 6.2 • Los precios contenidos en el catálogo no incluyen impuestos directos o indirectos, ni tasas o aranceles de naturaleza alguna.
- 6.3 • La tarifa aplicable en cada año de vigencia del catálogo publicado, será debidamente notificada a los clientes de FRICOSMOS, S.A. por cualquier medio habilitado en derecho.
- 6.4 • FRICOSMOS, S.A. hará constar el precio de la mercancía vendida en el presupuesto ofertado al cliente y en la factura que relaciona los productos vendidos de acuerdo con las tarifas vigentes.
- 6.5 • FRICOSMOS, S.A. y el cliente-comprador establecerán las formas de pago de las mercancías adquiridas en la carta de condiciones, y en su defecto, el precio será abonado en su integridad una vez puestas las mercancías a disposición del comprador.
- 6.6 • FRICOSMOS, S.A., se reserva el derecho a rectificar las erratas o errores materiales de que pudiera adolecer las presentes condiciones generales de venta.

7.0 falta de pago

- 7.1 • Todos los retrasos en el pago del precio sobre el plazo estipulado, generarán el interés legal del dinero incrementado en 2 puntos mensualmente, y en el concepto de pena convencional.
- 7.2 • Todos los gastos que se originen, tanto judiciales como extrajudiciales, incluyendo los gastos bancarios, notariales, de abogados, de procuradores, etc., por el impago de recibos, letras de cambio, pagarés, cheques, etc., se pagarán por la parte compradora.

8.0 garantía de los productos fabricados por fricosmos, S.A.

- 8.1 • Todos los productos incluidos en nuestro catálogo, gozan de una garantía de DOS AÑOS contado a partir de la fecha de entrega de la mercancía.
 - 8.1.1 • Los productos fabricados por Fricosmos, S.A. que pudieran adolecer de algún defecto de fabricación, serán reparados o sustituidos por otro de iguales características, siempre que por parte del cliente se cumplan en debida forma los requisitos que con toda claridad y precisión se detallan a continuación:
 - 1| Que el cliente avise por escrito a Fricosmos, S.A. de la existencia de un posible defecto.
 - 2| Que la pieza que tiene que ser sustituida sea enviada a la sede de nuestra empresa para su oportuna revisión.
 - 3| Que el cliente abone los portes de ida y vuelta de la pieza que tiene que ser susceptible de reposición o reparación.
 - 4| El cliente goza de una garantía en todos los productos que adquiera, que despliega sus efectos dentro de la instalación comercial de FRICOSMOS, S.A. pero en ningún caso podrá asumirse en el exterior.
- 8.2 • Los servicios técnicos de Fricosmos, S.A. asumen la responsabilidad de examinar la pieza o mercancía remitida por el cliente para corroborar la existencia de un posible defecto de fabricación.
- 8.3 • Si del dictamen de la oficina técnica de Fricosmos, S.A. se determina la existencia de un defecto de fabricación, Fricosmos, S.A. vendrá obligado a sustituir o reparar la mercadería que fue comprada por el cliente, le será enviada al domicilio social que figure en el albarán originario sin coste alguno para el cliente excepto los portes.
- 8.4 • Las piezas o materiales serán siempre sustituidos por otros de iguales características o calidades.
- 8.5 • El cambio o la sustitución de las piezas defectuosas no incluyen ni la instalación ni la mano de obra que haya de ser realizada por terceras personas.
- 8.6 • El cliente tiene pleno derecho a recibir información técnica del dictamen emitido por el fabricante.
- 8.7 • Quedan excluidos de garantía los consumibles, como por ejemplo los tubos fluorescentes, bombillas, lámparas de ozono, etc.

9.0 reclamaciones

Las posibles reclamaciones acerca del estado o de la cantidad de la mercancía, se efectuarán por escrito (carta, fax o correo electrónico), en el plazo de los ocho días siguientes a su recepción, excepto las referentes a material golpeado, que seguirán el procedimiento marcado en los puntos 4.3 y 4.4. Se deberá adjuntar a cada reclamación los datos de número de pedido, número de albarán y número de factura.

10.0 devolución de mercancías

- 10.1 • No se admitirán devoluciones sin el previo consentimiento expreso por parte de FRICOSMOS, S.A.
- 10.2 • No se admitirá en ningún caso, la devolución de materiales usados, sin plástico protector, los probados o los encargados a medida.
- 10.3 • Todos los gastos de retorno de la mercancía a devolver, manipulación, embalajes y seguro, correrán por parte del comprador, siendo estos los encargados de reclamar los daños o pérdidas que se pudieran ocasionar.
- 10.4 • Fricosmos se reserva el derecho de admisión de la devolución hasta su inspección de calidad y cantidad de la mercancía en nuestras instalaciones de Móstoles.
- 10.5 • El importe a abonar se descontará en la próxima compra.

11.0 reserva de dominio

- 11.1 • El vendedor se reserva el dominio de la mercancía vendida hasta el pago completo de todas las cantidades que el comprador le adeude.
- 11.2 • El vendedor se reserva el derecho de dar por rescindido el contrato si el comprador no cumpliera cualquiera de las condiciones Generales de Venta, reseñadas en virtud de ello, exigir los reintegros, garantías o indemnización de perjuicios que conviniera a sus intereses o hubiera lugar en derecho.

12.0 legislación aplicable

La interposición de las presentes Condiciones de Venta se encuentra amparada en el Código Civil y en el Código de Comercio, así como en la Ley 7/1998 de 13 de Abril de Condiciones General de la Contratación y en la Ley 16/1987 de 30 de Julio de Ordenación de los Transportes Terrestres.

13.0 jurisdicción

- 13.1 • El contrato de compraventa se entenderá siempre realizado en España, rigiéndose por la normativa legal Española en todo lo no previsto en las presentes condiciones generales de venta.
- 13.2 • Cualquier divergencia surgida como consecuencia del contrato de venta establecido, deberá ser resuelta ante los juzgados y tribunales de Móstoles (Madrid), a cuyo fuero se someten expresamente comprador y vendedor, renunciando de manera expresa al que pudiera corresponderles.
- 13.3 • Queda especialmente convenido que todos los giros impagados o los plazos vencidos serán reclamados, así como la acción ejecutiva que de ellos dimane, ante los juzgados o tribunales de Móstoles (Madrid) España, aunque sea otro el domicilio del aceptante o el lugar de pago indicado en las letras.

■ General conditions

1.0 Merchandise offer

- 1.1 • Every product included in the current catalogue are according to the current rules as regards verification and quality required by the National and European Regulations, within Fricosmos business context.
- 1.2 • All the range of products that Fricosmos, S.A. has indexed in the current catalogue are within the limits of application of the current General Conditions of Sale.
- 1.3 • The purchaser will realize the orders in the terms and conditions expressly published by Fricosmos, S.A. in the merchandise catalogue.
- 1.4 • Fricosmos, S.A. reserves the right to modify the articles included in the catalogue according to the manufacturing needs or to the existence in the market of the necessary raw material.

2.0 quotations and orders

- 2.1 • Orders will be effected verbally or in writing, favouring always the possibility of purchasing through the commercial service of Fricosmos, S.A.
- 2.2 • Once verified the registration of the customer by Fricosmos, S.A., the corresponding letter of conditions will be issued, detailing the commercial conditions that will rule in the future for both parties.
- 2.3 • The order will be subject to the definite acceptance of Fricosmos, S.A.
- 2.4 • The validity period for any quotation will be of 30 days from its issue date.
- 2.5 • In case that an product requires a special dimension or characteristics by the customer expressed request, he will be obliged to guarantee in advance a 50% of the total amount.
- 2.6 • The lack of payment by party of the purchaser will entitle Fricosmos, S.A. to dissolve the contract in the terms expressly established in the article 1124 of the Spanish Código Civil.

3.0 delivery time

- 3.1 • Since the goods included in the current catalogue are subject to a manufacturing process, the delivery time provided by Fricosmos, S.A. will be for guidance only .
- 3.2 • Fricosmos, S.A. will inform reliably to the purchaser about the manufacturing progress of his order in the assembly line in order to avoid delaying a possible harm to the customer.
- 3.3 • The punctual delivery delay will not cause any penalty or compensation., nor entitle the purchaser to cancel the order, as long as is due the manufacturing process.

4.0 merchandise transport

- 4.1 • The merchandise will ever be shipped ex works except agreement subscribed expressly with every customer, which will be duly reflected in the letter of conditions issued for this purpose.
- 4.2 • In case that the carriage of the merchandise is paid following the customer instructions or because is so stipulated in the letter of conditions, Fricosmos, S.A. will be exonerated of any possible defect or fault that could be attributed to the transport of the merchandise.
- 4.3 • In case that the carriage of the merchandise is paid by Fricosmos, S.A., the customer must notify Fricosmos, S.A. in writing and within 24 hours after the reception of the merchandise any defect or fault attributed to the transport agency in order to make easier the responsibility claim in accordance to the regulation 16/1987 of the Spanish Ordenación de los Transportes Terrestres and the RD 1111/1990 by which the regulation of the LOTI is approved.
- 4.4 • No merchandise returns will be admitted if the defect or fault is attributed to transport agency except in case that the customer complies the following requirement: That he notifies the incidence to Fricosmos, S.A. and/or to the transport agency within 24 hours after the reception of the merchandise or within the period legally determined at the time of the shipment by the Spanish Ley de Ordenación de Transportes Terrestres.
- 4.5 • The claim against the transport agency for defect or fault must be done at the reception of the goods whenever are apparent damages and within 24 hours after their reception if they are non-apparent. The claim must be done in writing.

5.0 delivery of the merchandise

- 5.1 • The contract relationship will be completed whenever Fricosmos, S.A. delivers the merchandise through the way of carriage stipulated in the letter of conditions and the vendor signs the reception note or delivery note prior inspection.
- 5.2 • If the purchaser rejects the reception of the sold goods without a just cause, Fricosmos, S.A. will be entitled to demand the expiration or cancellation of the contract, and the expenses will be charged on the account of the party that would have originated it.

6.0 prices and way of payment

- 6.1 • The prices of the product offered by Fricosmos, S.A. within the limits of its business activity are the included in the current price-list.
- 6.2 • The prices included in the catalogue does not include direct or indirect taxes, nor rates or duties.
- 6.3 • The price-list applicable every year of validity of the published catalogue will be duly notified to Fricosmos, S.A. customers by any means legally authorized.
- 6.4 • Fricosmos, S.A. will reflect the price of every merchandise sold in the offer quoted to the customer and in the invoice listing the sold products in accordance with the valid price-list.
- 6.5 • Fricosmos and the customer-purchaser will establish the means of payment for the acquired merchandises in the letter of conditions, and in default, the price will be fully charged once the merchandise at the purchaser disposition.
- 6.6 • Fricosmos, S.A. reserves the right to rectify the mistakes or material errors which could present the current general conditions of sale.

7.0 arrears of payment

- 7.1 • All arrear in payment over the stipulated period will generate the legal currency interest increased in 2 points per month in concept of conventional penalty.
- 7.2 • All expenses originated in the failure of payment of accounts, bills of exchange, bonds, cheques, as much judicial as out-of-law, including expenses for bank, notary, lawyer, solicitor etc. will be charged to the purchaser party.

8.0 warranty of the products manufactured by Fricosmos, S.A.

- 8.1 • All products included in our catalogue are guaranteed for TWO YEARS from the delivery date on.
 - 8.1.1 • The products manufactured by Fricosmos, S.A. that could have suffered any manufacture defect will be repaired or substituted by another of the same characteristics whenever the customer carries out all the requirements clearly detailed below:
 - 1|The customer must advise in writing Fricosmos, S.A. of the existence of a possible defect.
 - 2|The piece to be substituted must be shipped to our firms headquarters for its corresponding inspection.
 - 3|The customer must pay the outward and the backward of the piece that must be repaired or returned
 - 4|The customer possesses for any product acquired a guarantee effective within Fricosmos, S.A. commercial installations, never assumed outside them.
 - 8.1.2 • Fricosmos Technical Service takes on the responsibility of inspecting the piece or merchandise received from the customer to corroborate the existence of a possible defect of manufacture.
 - 8.1.3 • If the final report of the Technical Service of Fricosmos, S.A. determines the existence of a defect of manufacture, Fricosmos, S.A. will be obliged to substitute or repair the merchandise acquired by the customer, and it will be resent to the delivery note original address without any additional cost, except the transport.
 - 8.1.4 • Pieces or materials will ever be substituted by another of the same characteristics or quality.
 - 8.1.5 • The change or substitution of the defect parts do not include neither installing or labour which must be done by a third party.
 - 8.1.6 • The customer has full right to receive technical information about the report issued by the manufacturer.
 - 8.1.7 • All the consumable products such as fluorescent tubes, bulbs, ozone lamps, etc. are excluded from this warranty.

9.0 claims

Any possible claims concerning the condition or the quantity of the merchandise, must be carried out in writing (via fax, e-mail or mail) within the next eight days after its reception, except those referring to damaged material which will follow the procedure indicated in 4.3 and 4.4. The mentioned claiming must be accompanied by the order details, number of the delivery note and invoice number.

10.0 returns of merchandise

- 10.1 • No return will be accepted without previous consent expressed by Fricosmos, S.A.
- 10.2 • Fricosmos, S.A. will not accept under any circumstance the return of used, tested, without protective plastic or custom-made material.
- 10.3 • The purchaser will take care of all costs of shipping, handling, packaging and insurance to return the goods and will be responsible for claiming any damage or loss that may result from this circumstance.
- 10.4 • Fricosmos reserves the right to refuse de admission of the returned goods until their inspection for quality and quantity in our facilities in Móstoles.
- 10.5 • Once the goods has been accepted as returned properly the total amount to be credited will be deduced from the next purchase.

11.0 reserve of property

- 11.1 • The vendor reserves the right of ownership of the purchased goods until the full amount that is owed by the purchaser is paid.
- 11.2 • The vendor reserves the right to terminate the contract if the purchaser does not comply with all of the General Conditions of Sale mentioned. By virtue of this, Fricosmos, S.A. is entitled to demand the payment, warranties or compensation for damages suitable to their interests.

12.0 applicable legislation

- 12.1 • The insertion of the current Sales conditions is in accordance with the Spanish Código Civil and the Código de Comercio, as well as with the regulations 7/1998 from 13th April on the Spanish Condiciones Generales de Contratación and 16/1987 from 30th July on the Ordenación de los Transportes Terrestres.

13.0 jurisdiction

- 13.1 • The contract of sale is always understood to be executed in Spain and is governed by the legal norms of Spain in all aspects non covered by the current General Conditions of Sale.
- 13.2 • Any divergence arising as a consequence of an established contract of sale must be resolved by the Courts and Tribunals of Móstoles (Madrid), to whose jurisdiction both the purchaser and the vendor are expressly subjected, and renouncing expressly to any other which might correspond to them.13.3 It is expressly agreed that all unpaid accounts or installment payments due will be reclaimed, as well as the executive action arising from them, before the Courts and Tribunals of Móstoles (Madrid) España, even if the address of the acceptor is elsewhere or the place of payments indicated in correspondence is elsewhere.

1.0 offre de marchandises

- 1.1 • Tous les produits inclus dans ce catalogue-ci sont soutenus par la réglementation en vigueur en matière de vérification et qualité exigée par la loi de l'État Espagnol et l'Union Européenne, dans le cadre de l'activité commerciale de Fricosmos, S.A.
- 1.2 • Le cadre d'application de ces conditions générales de vente comprend toute la gamme des produits de ce catalogue.
- 1.3 • L'acheteur réalisera les commandes en termes et conditions expressément publiés par Fricosmos dans ce catalogue.
- 1.4 • Fricosmos, S.A. réserve le droit de modifier les articles inclus dans ce catalogue en fonction des besoins de la production ou de l'existence dans le marché de la matière première pour sa fabrication.

2.0 commandes et offres

- 2.1 • Les commandes pourront s'effectuer de façon verbale ou écrite, tout en favorisant la possibilité d'acheter à travers de tous les services commerciaux de Fricosmos, S.A.
- 2.2 • Une fois l'inscription du client soit vérifiée par Fricosmos, S.A., on expédiera la lettre de conditions opportune dans laquelle on détaillera les conditions commerciales qui régiront dès ce moment entre les deux parties.
- 2.3 • La commande est conditionnée à l'acceptation définitive par Fricosmos, S.A.
- 2.4 • Le délai de validité d'une offre sera de 30 jours à partir de la date de l'offre.
- 2.5 • Le client sera tenu de garantir le 50 % du prix d'avance quand la commande requerra une mesure spéciale ou des caractéristiques concrètes par requête expresse du client.

3.0 délais de livraison

- 3.1 • Le délai de livraison fourni par Fricosmos, S.A. aura le caractère d'approximatif puis que la marchandise incluse dans ce catalogue est subordonné à un procès de fabrication du produit demandé par l'acheteur.
- 3.2 • Fricosmos, S.A. informera à l'acheteur ponctuellement de l'état d'élaboration de sa commande dans la chaîne de production pour éviter le retard et le conséquent préjudice au client.
- 3.3 • Les retards de livraison éventuels ne pourront pas donner lieu à aucune sanction ou indemnisation par dommages et intérêts. Ils n'autoriseront pas non plus à annuler la commande, quand le retard soit imputable au procès de fabrication.

4.0 transport de la marchandise

- 4.1 • La marchandise voyagera toujours à ports dus sauf accord suscrit expressément avec chacun des clients, ce qui restera dûment exprimé dans la lettre de conditions qui sera expédiée au client.
- 4.2 • Quand la marchandise voyage à ports dus par désir exprès du client ou parce que dans la lettre de conditions on a fait ce pacte, Fricosmos, S.A. est exonéré des possibles tares ou défauts qui pourraient être imputables au transport de la marchandise.
- 4.3 • Quand la marchandise voyage à ports payés par Fricosmos, S.A., le client doit notifier à Fricosmos, S.A. par écrit dans les 24 heures suivantes à la réception de la marchandise de n'importe quel défaut ou tare imputable à la compagnie de transports pour faciliter la réclamation de la responsabilité dans le cadre de la loi espagnole 16/1.987 d'Ordonnances des Transports Terrestres et Royal Décret espagnol 1.111/1.990 par lequel s'approuve le règlement de la LOTT (loi d'Ordonnances des Transports Terrestres).
- 4.4 • On n'admettra pas dévolution de marchandise avec une tare ou un défaut imputable à la compagnie de transport, sauf que le client accomplisse la condition suivante : Notifier à Fricosmos, S.A. et / ou à l'agence de transport dans les 24 heures suivantes à la réception de la marchandise ou dans le délai établi légalement à chaque moment dans la Loi d'Ordonnances des Transports Terrestres espagnole.
- 4.5 • La réclamation contre la compagnie de transport par dommage ou panne, devra se faire à la réception des colis quand il s'agit de dommages apparents et dans les 24 heures suivantes à la réception si les dommages ne sont pas apparents. La plainte ou réserve doit se faire par écrit.

5.0 remise de marchandises

- 5.1 • La relation contractuelle sera perfectionnée lorsque Fricosmos, S.A. remettra la marchandise à l'acheteur par le moyen de transport accordé dans la lettre de conditions et lorsque l'acheteur signera le bon de livraison ou document de remise.
- 5.2 • Dans le cas où l'acheteur refuse la marchandise sans une cause juste à la réception des biens achetés, Fricosmos, S.A. pourra demander l'accomplissement ou la résiliation du contrat. Les frais dérivés seront à la charge de la personne qui ait donné le motif pour les constituer.

6.0 prix et mode de paiement

- 6.1 • Les prix des produits offerts par Fricosmos, S.A. dans le cadre de son activité commerciale, sont ceux contenus dans la tarification en vigueur.
- 6.2 • Les prix contenus dans le catalogue n'incluent pas des impôts directs ou indirects, ni des taxes ni des tarifs douaniers d'aucune nature.
- 6.3 • La tarification applicable à chaque année de vigueur du catalogue publié, sera dûment notifiée aux clients de Fricosmos, S.A. par n'importe quel moyen habilité en droit.
- 6.4 • Fricosmos, S.A. fera figurer le prix de la marchandise vendue dans le devis offert au client et dans la facture qui refléchira les produits vendus d'accord aux tarifs en vigueur.
- 6.5 • Fricosmos, S.A. et le client-acheteur établiront les façons de paiement des marchandises acquises dans la lettre de conditions, et à défaut de cette lettre, le prix sera payé intégralement une fois les marchandises sont mis à disposition de l'acheteur.
- 6.6 • Fricosmos, S.A. réserve le droit de rectifier les erratum ou les fautes matérielles qui pourront exister dans ces conditions générales de vente.

7.0 manque de paiement

- 7.1 • Tous les retards dans le paiement du prix au-dessus du délai stipulé, généreront l'intérêt légal de l'argent augmenté deux points à chaque mois à titre de sanction conventionnelle.
- 7.2 • Tous les frais qui se génèrent, soit judiciaires, soit extra judiciaires, tout en incluant les frais bancaires, notariaux, d'avocats, de huissiers etc. par la manque de paiement de reçus, lettres de change, traites, chèques, billets à l'ordre etc. seront payés par la part acheteuse.

8.0 Garantie des produits fabriqués par Fricosmos, S.A.

- 8.1 • Tous les produits inclus dans ce catalogue ont une garantie DEUX ANS à partir de la date de remise de la marchandise.
 - 8.1.1 • Les produits fabriqués par Fricosmos, S.A. qui pourront avoir quelque défaut de fabrication seront réparés ou substitués par un autre des mêmes caractéristiques, pourvu que le client aie accompli les conditions qui avec précision sont détaillés ci-dessous:
 - 1| Que le client notifie par écrit à Fricosmos, S.A. de l'existence d'un éventuel défaut.
 - 2| Que la pièce à substituer soit envoyé à l'adresse de notre société pour une révision.
 - 3| Que le client paie le transport d'aller et de retour de la pièce qui va se réviser ou réparer.
 - 4| Le client a une garantie dans tous les produits qu'il achète qui n'est valable que dans l'installation commerciale de Fricosmos, S.A. Fricosmos, S.A. ne pourra pas assumer une garantie à l'extérieur des installations de Fricosmos, S.A.
- 8.1.2 • Les services techniques de Fricosmos, S.A. assument la responsabilité d'examiner la pièce ou marchandise envoyé par le client pour corroborer l'existence d'un éventuel défaut de fabrication.
- 8.1.3 • Si le rapport des techniciens de Fricosmos, S.A. détermine l'existence d'un défaut de fabrication, Fricosmos, S.A. sera obligé de substituer ou réparer la marchandise achetée par le client, et elle sera envoyée à l'adresse du bon de livraison original sans coût additionnel pour le client, sauf le transport.
- 8.1.4 • Les pièces ou matériaux seront toujours substitués par des autres avec les mêmes caractéristiques ou qualités.
- 8.1.5 • Le changement ou substitution des pièces avec des défauts n'inclut pas l'installation ni la main d'œuvre de troisièmes parties.
- 8.1.6 • Le client a plein droit à recevoir des renseignements techniques sur le rapport émis par le fabricant.
- 8.1.7 • Tous les produits consommables tels que les tubes fluorescents, ampoules, lampes d'ozone, etc sont exclus de cette garantie.

9.0 réclamations

Les réclamations possibles en relation avec l'état ou la quantité de la marchandise seront effectuées par écrit (fax, e-mail ou poste), dans un délai de huit jours après sa réception, sauf les réclamations concernant aux produits abîmés, auxquelles on appliquera les conditions des points 4.3 et 4.4. Le client devra ajouter à la réclamation les données de la commande, le numéro de bon de livraison et le numéro de facture.

10.0 dévolution de marchandises

- 10.1 • Fricosmos, S.A. n'admettra pas des dévolutions sans une autorisation préalable par Fricosmos, S.A.
- 10.2 • Fricosmos, S.A. n'admettra aucune dévolution de matériaux usagés, éprouvés ou commandés sur mesure.
- 10.3 • Tous les frais de transport, la manutention, l'emballage et l'assurance pour retourner la marchandise seront à la charge de l'acheteur, qui sera aussi responsable de réclamer tout dommage ou perte qui pourrait résulter de cette circonstance.
- 10.4 • Fricosmos se réserve le droit de refuser l'admission des marchandises retournées jusqu'à leur inspection de la qualité et la quantité dans nos installations à Móstoles.
- 10.5 • Une fois que les marchandises ont été acceptées comme retournées correctement, le montant total à créditer sera déduit de l'achar prochain.

11.0 réservation de propriété

- 11.1 • Le vendeur se réserve la propriété des marchandises vendues jusqu'au paiement complet de toutes les quantités dues par l'acheteur.
- 11.2 • Le vendeur se réserve le droit d'annuler le contrat si l'acheteur n'exécute pas une ou plusieurs des conditions générales de vente, ici signalées, d'exiger les remboursements, les garanties ou l'indemnisation des dommages qui conviennent à ses intérêts qu'il y ait lieu en droit.

12.0 législation applicable

L'interposition de ces conditions de vente est encadrée dans le Code Civil, dans le Code de Commerce, dans la loi espagnole 7/1.998 du 13 avril de « Condiciones Generales de la Contratación » et dans la loi espagnole 16/1.987 de 30 juillet de Ordenación de los Transportes Terrestres

13.0 juridiction

- 13.1 • Le contrat de vente sera entendu comme réalisé toujours en Espagne, s'y appliquant la normative légale espagnole en tout ce qui n'est pas prévu dans les présentes conditions générales de vente.
- 13.2 • Toute divergence qui puisse surgir comme conséquence du contrat de vente établi devra être solutionnée devant les tribunaux de Móstoles (Madrid) Espagne, auxquels se soumettent de forme expresse tant l'acheteur que le vendeur, renonçant expressément à ceux qui en fait pourraient leur correspondre.
- 13.3 • Il est surtout convenu que tous les virements non payés ou les délais échus seront demandés, ainsi que l'acte d'exécution qui en dérive, devant les tribunaux de Móstoles (Madrid) Espagne, même quand le domicile de l'acceptant ou l'endroit du paiement des lettres soit ailleurs.